

CalculiX CrunchiX USER'S MANUAL version 2.21

Guido Dhondt

July 29, 2023

Contents

1	Introduction.	12
2	How to perform CalculiX calculations in parallel	12
3	Units	14
4	Golden rules	16
5	Simple example problems	20
5.1	Cantilever beam	20
5.2	Frequency calculation of a beam loaded by compressive forces . . .	26
5.3	Frequency calculation of a rotating disk on a slender shaft	27
5.4	Thermal calculation of a furnace	34
5.5	Seepage under a dam	39
5.6	Capacitance of a cylindrical capacitor	41
5.7	Hydraulic pipe system	45
5.8	Lid-driven cavity	50
5.9	Transient laminar incompressible Couette problem	56
5.10	Stationary laminar inviscid compressible airfoil flow	56
5.11	Laminar viscous compressible compression corner flow	61
5.12	Laminar viscous compressible airfoil flow	64
5.13	Channel with hydraulic jump	65
5.14	Cantilever beam using beam elements	67
5.15	Reinforced concrete cantilever beam	73
5.16	Wrinkling of a thin sheet	77
5.17	Optimization of a simply supported beam	79
5.18	Mesh refinement of a curved cantilever beam	84

6	Theory	90
6.1	Node Types	93
6.2	Element Types	93
6.2.1	Eight-node brick element (C3D8 and F3D8)	94
6.2.2	C3D8R	94
6.2.3	Incompatible mode eight-node brick element (C3D8I)	96
6.2.4	Twenty-node brick element (C3D20)	97
6.2.5	C3D20R	98
6.2.6	Four-node tetrahedral element (C3D4 and F3D4)	99
6.2.7	Ten-node tetrahedral element (C3D10)	99
6.2.8	Modified ten-node tetrahedral element (C3D10T)	101
6.2.9	Six-node wedge element (C3D6 and F3D6)	101
6.2.10	Fifteen-node wedge element (C3D15)	101
6.2.11	Three-node shell element (S3)	101
6.2.12	Four-node shell element (S4 and S4R)	104
6.2.13	Six-node shell element (S6)	104
6.2.14	Eight-node shell element (S8 and S8R)	105
6.2.15	Three-node membrane element (M3D3)	112
6.2.16	Four-node membrane element (M3D4 and M3D4R)	112
6.2.17	Six-node membrane element (M3D6)	112
6.2.18	Eight-node membrane element (M3D8 and M3D8R)	112
6.2.19	Three-node plane stress element (CPS3)	112
6.2.20	Four-node plane stress element (CPS4 and CPS4R)	113
6.2.21	Six-node plane stress element (CPS6)	113
6.2.22	Eight-node plane stress element (CPS8 and CPS8R)	113
6.2.23	Three-node plane strain element (CPE3)	115
6.2.24	Four-node plane strain element (CPE4 and CPE4R)	115
6.2.25	Six-node plane strain element (CPE6)	115
6.2.26	Eight-node plane strain element (CPE8 and CPE8R)	115
6.2.27	Three-node axisymmetric element (CAX3)	116
6.2.28	Four-node axisymmetric element (CAX4 and CAX4R)	116
6.2.29	Six-node axisymmetric element (CAX6)	116
6.2.30	Eight-node axisymmetric element (CAX8 and CAX8R)	116
6.2.31	Two-node 2D beam element (B21)	118
6.2.32	Two-node 3D beam element (B31 and B31R)	118
6.2.33	Three-node 3D beam element (B32 and B32R)	119
6.2.34	Two-node 2D truss element (T2D2)	124
6.2.35	Two-node 3D truss element (T3D2)	126
6.2.36	Three-node 3D truss element (T3D3)	126
6.2.37	Three-node network element (D)	126
6.2.38	Two-node unidirectional gap element (GAPUNI)	127
6.2.39	Two-node 3-dimensional dashpot (DASHPOTA)	127
6.2.40	One-node 3-dimensional spring (SPRING1)	128
6.2.41	Two-node 3-dimensional spring (SPRING2)	128
6.2.42	Two-node 3-dimensional spring (SPRINGA)	129
6.2.43	One-node coupling element (DCOUP3D)	129

6.2.44	One-node mass element (MASS)	130
6.2.45	User Element (Uxxxx)	130
6.2.46	User Element: 3D Timoshenko beam element (U1)	130
6.2.47	User Element: 3-node shell element (US3)	130
6.2.48	Substructure (Superelement)	131
6.3	Beam Section Types	132
6.3.1	Pipe	132
6.3.2	Box	133
6.3.3	General	135
6.4	Fluid Section Types: Gases	135
6.4.1	Orifice	140
6.4.2	Bleed Tapping	143
6.4.3	Preswirl Nozzle	144
6.4.4	Straight and Stepped Labyrinth	146
6.4.5	Characteristic	149
6.4.6	Carbon Seal	151
6.4.7	Gas Pipe (Fanno)	151
6.4.8	Rotating Gas Pipe (subsonic applications)	158
6.4.9	Restrictor, Long Orifice	161
6.4.10	Restrictor, Enlargement	165
6.4.11	Restrictor, Contraction	166
6.4.12	Restrictor, Bend	167
6.4.13	Restrictor, Wall Orifice	168
6.4.14	Restrictor, Entrance	170
6.4.15	Restrictor, Exit	170
6.4.16	Restrictor, User	171
6.4.17	Branch, Joint	171
6.4.18	Branch, Split	175
6.4.19	Cross, Split	178
6.4.20	Vortex	179
6.4.21	Möhring	184
6.4.22	Change absolute/relative system	185
6.4.23	In/Out	188
6.4.24	Mass Flow Percent	188
6.4.25	Network User Element	189
6.5	Fluid Section Types: Liquids	190
6.5.1	Pipe, Manning	190
6.5.2	Pipe, White-Colebrook	191
6.5.3	Pipe, Sudden Enlargement	193
6.5.4	Pipe, Sudden Contraction	194
6.5.5	Pipe, Entrance	195
6.5.6	Pipe, Diaphragm	195
6.5.7	Pipe, Bend	196
6.5.8	Pipe, Gate Valve	197
6.5.9	Pump	198
6.5.10	In/Out	200

6.6	Fluid Section Types: Open Channels	200
6.6.1	Straight Channel	200
6.6.2	Sluice Gate	201
6.6.3	Weir	203
6.6.4	Reservoir	204
6.6.5	Contraction	205
6.6.6	Enlargement	209
6.6.7	Step	210
6.6.8	Channel joint	211
6.6.9	In/Out	212
6.7	Boundary conditions	212
6.7.1	Single point constraints (SPC)	212
6.7.2	Multiple point constraints (MPC)	212
6.7.3	Kinematic and Distributing Coupling	213
6.7.4	Mathematical description of a knot	217
6.7.5	Node-to-Face Penalty Contact	220
6.7.6	Face-to-Face Penalty Contact	236
6.7.7	Face-to-Face Mortar Contact	242
6.7.8	Massless Node-to-Face Contact	243
6.8	Materials	252
6.8.1	Linear elasticity	252
6.8.2	Linear elasticity for large strains (Ciarlet model)	253
6.8.3	Linear elasticity for rotation-insensitive small strains	255
6.8.4	Ideal gas for small pressure deviations	256
6.8.5	Ideal gas for large deformations	256
6.8.6	Hyperelastic and hyperfoam materials	257
6.8.7	Deformation plasticity	258
6.8.8	Incremental (visco)plasticity: multiplicative decomposition	258
6.8.9	Incremental (visco)plasticity: additive decomposition	260
6.8.10	Plasticity with Johnson-Cook hardening.	260
6.8.11	Mohr-Coulomb plasticity.	261
6.8.12	Tension-only and compression-only materials.	271
6.8.13	Fiber reinforced materials.	272
6.8.14	The Cailletaud single crystal model.	273
6.8.15	The Cailletaud single crystal creep model.	277
6.8.16	Elastic anisotropy with isotropic viscoplasticity.	278
6.8.17	Elastic anisotropy with user defined isotropic creep.	282
6.8.18	User materials	283
6.9	Types of analysis	287
6.9.1	Static analysis	287
6.9.2	Frequency analysis	288
6.9.3	Complex frequency analysis	293
6.9.4	Buckling analysis	294
6.9.5	Modal dynamic analysis	295
6.9.6	Steady state dynamics	298
6.9.7	Direct integration dynamic analysis	300

6.9.8	Heat transfer	307
6.9.9	Acoustics	308
6.9.10	Shallow water motion	310
6.9.11	Hydrodynamic lubrication	311
6.9.12	Irrotational incompressible inviscid flow	311
6.9.13	Electrostatics	312
6.9.14	Stationary groundwater flow	314
6.9.15	Diffusion mass transfer in a stationary medium	316
6.9.16	Aerodynamic Networks	317
6.9.17	Hydraulic Networks	320
6.9.18	Turbulent Flow in Open Channels	323
6.9.19	Three-dimensional Navier-Stokes Calculations	330
6.9.20	Shallow water calculations	344
6.9.21	Substructure Generation	349
6.9.22	Electromagnetism	350
6.9.23	Sensitivity	362
6.9.24	Feasible Direction	365
6.9.25	Robust Design	367
6.9.26	Green functions	367
6.9.27	Crack propagation	368
6.10	Convergence criteria	373
6.10.1	Thermomechanical iterations	373
6.10.2	Contact	376
6.10.3	Line search	379
6.10.4	Network iterations	379
6.10.5	Implicit dynamics	380
6.11	Loading	382
6.11.1	Point loads	383
6.11.2	Facial distributed loading	383
6.11.3	Centrifugal distributed loading	386
6.11.4	Gravity distributed loading	387
6.11.5	Forces obtained by selecting RF	387
6.11.6	Temperature loading in a mechanical analysis	390
6.11.7	Initial(residual) stresses	390
6.11.8	Concentrated heat flux	390
6.11.9	Distributed heat flux	390
6.11.10	Convective heat flux	390
6.11.11	Radiative heat flux	391
6.12	Error estimators	391
6.12.1	Zienkiewicz-Zhu error estimator	391
6.12.2	Gradient error estimator	392
6.13	Output variables	393

7	Input deck format	396
7.1	*AMPLITUDE	397
7.2	*BASE MOTION	399
7.3	*BEAM SECTION	400
7.4	*BOUNDARY	402
	7.4.1 Homogeneous Conditions	404
	7.4.2 Inhomogeneous Conditions	405
	7.4.3 Submodel	406
7.5	*BUCKLE	406
7.6	*CFD	408
7.7	*CFLUX	410
7.8	*CHANGE CONTACT TYPE	412
7.9	*CHANGE FRICTION	413
7.10	*CHANGE MATERIAL	413
7.11	*CHANGE PLASTIC	414
7.12	*CHANGE SOLID SECTION	415
7.13	*CHANGE SURFACE BEHAVIOR	415
7.14	*CLEARANCE	416
7.15	*CLOAD	416
7.16	*COMPLEX FREQUENCY	419
7.17	*CONDUCTIVITY	420
7.18	*CONSTRAINT	421
7.19	*CONTACT DAMPING	423
7.20	*CONTACT FILE	424
7.21	*CONTACT OUTPUT	427
7.22	*CONTACT PAIR	427
7.23	*CONTACT PRINT	429
7.24	*CONTROLS	431
7.25	*CORRELATION LENGTH	436
7.26	*COUPLED TEMPERATURE-DISPLACEMENT	437
7.27	*COUPLING	440
7.28	*CRACK PROPAGATION	441
7.29	*CREEP	442
7.30	*CYCLIC HARDENING	443
7.31	*CYCLIC SYMMETRY MODEL	444
7.32	*DAMPING	446
7.33	*DASHPOT	447
7.34	*DEFORMATION PLASTICITY	448
7.35	*DENSITY	449
7.36	*DEPVAR	450
7.37	*DESIGN RESPONSE	450
7.38	*DESIGN VARIABLES	453
7.39	*DFLUX	453
7.40	*DISTRIBUTING	457
7.41	*DISTRIBUTING COUPLING	459
7.42	*DISTRIBUTION	461

7.43	*DLOAD	463
7.44	*DSLOAD	468
7.45	*DYNAMIC	470
7.46	*ELASTIC	473
7.47	*ELECTRICAL CONDUCTIVITY	475
7.48	*ELECTROMAGNETICS	476
7.49	*ELEMENT	479
7.50	*ELEMENT OUTPUT	482
7.51	*EL FILE	483
7.52	*EL PRINT	488
7.53	*ELSET	490
7.54	*END STEP	491
7.55	*EQUATION	492
7.56	*EXPANSION	494
7.57	*FEASIBLE DIRECTION	495
7.58	*FILM	496
7.59	*FILTER	501
7.60	*FLUID CONSTANTS	502
7.61	*FLUID SECTION	502
7.62	*FREQUENCY	504
7.63	*FRICTION	506
7.64	*GAP	507
7.65	*GAP CONDUCTANCE	508
7.66	*GAP HEAT GENERATION	509
7.67	*GEOMETRIC CONSTRAINT	510
7.68	*GEOMETRIC TOLERANCES	511
7.69	*GREEN	512
7.70	*HCF	513
7.71	*HEADING	514
7.72	*HEAT TRANSFER	515
7.73	*HYPERELASTIC	519
7.74	*HYPERFOAM	525
7.75	*INCLUDE	526
7.76	*INITIAL CONDITIONS	527
7.77	*INITIAL MESH	531
7.78	*INITIAL STRAIN INCREASE	531
7.79	*KINEMATIC	533
7.80	*MAGNETIC PERMEABILITY	534
7.81	*MASS	535
7.82	*MASS FLOW	536
7.83	*MATERIAL	537
7.84	*MATRIX ASSEMBLE	538
7.85	*MEMBRANE SECTION	538
7.86	*MODAL DAMPING	539
7.87	*MODAL DYNAMIC	540
7.88	*MODEL CHANGE	542

7.89 *MOHR COULOMB	544
7.90 *MOHR COULOMB HARDENING	545
7.91 *MPC	545
7.92 *NETWORK MPC	547
7.93 *NO ANALYSIS	547
7.94 *NODAL THICKNESS	548
7.95 *NODE	549
7.96 *NODE FILE	550
7.97 *NODE OUTPUT	554
7.98 *NODE PRINT	554
7.99 *NORMAL	557
7.100 *NSET	558
7.101 *OBJECTIVE	559
7.102 *ORIENTATION	559
7.103 *OUTPUT	562
7.104 *PHYSICAL CONSTANTS	562
7.105 *PLASTIC	563
7.106 *PRE-TENSION SECTION	565
7.107 *RADIATE	566
7.108 *RATE DEPENDENT	572
7.109 *REFINE MESH	572
7.110 *RESTART	573
7.111 *RETAINED NODAL DOFS	575
7.112 *RIGID BODY	576
7.113 *ROBUST DESIGN	577
7.114 *SECTION PRINT	578
7.115 *SELECT CYCLIC SYMMETRY MODES	580
7.116 *SENSITIVITY	581
7.117 *SHELL SECTION	582
7.118 *SOLID SECTION	583
7.119 *SPECIFIC GAS CONSTANT	584
7.120 *SPECIFIC HEAT	584
7.121 *SPRING	585
7.122 *STATIC	587
7.123 *STEADY STATE DYNAMICS	590
7.124 *STEP	593
7.125 *SUBMODEL	595
7.126 *SUBSTRUCTURE GENERATE	597
7.127 *SUBSTRUCTURE MATRIX OUTPUT	598
7.128 *SURFACE	599
7.129 *SURFACE BEHAVIOR	602
7.130 *SURFACE INTERACTION	604
7.131 *TEMPERATURE	604
7.132 *TIE	607
7.133 *TIME POINTS	609
7.134 *TRANSFORM	610

7.135*UNCOUPLED TEMPERATURE-DISPLACEMENT	612
7.136*USER ELEMENT	615
7.137*USER MATERIAL	616
7.138*USER SECTION	617
7.139*VALUES AT INFINITY	617
7.140*VIEWFACTOR	618
7.141*VISCO	619
8 User subroutines.	620
8.1 Creep (creep.f)	620
8.2 Hardening (uhardening.f)	622
8.3 User-defined initial conditions	623
8.3.1 Initial internal variables (sdvini.f)	623
8.3.2 Initial stress field (sigini.f)	623
8.4 User-defined loading	624
8.4.1 Concentrated flux (cflux.f)	624
8.4.2 Concentrated load (cload.f)	624
8.4.3 Distributed flux (dflux.f)	625
8.4.4 Distributed load (dload.f)	628
8.4.5 Heat convection (film.f)	629
8.4.6 Boundary conditions(uboun.f)	632
8.4.7 Heat radiation (radiate.f)	632
8.4.8 Temperature (utemp.f)	634
8.4.9 Amplitude (uamplitude.f)	634
8.4.10 Face loading (ufaceload.f)	634
8.4.11 Gap conductance (gapcon.f)	635
8.4.12 Gap heat generation (fricheat.f)	636
8.5 User-defined mechanical material laws.	636
8.5.1 The CalculiX interface.	637
8.5.2 ABAQUS umat routines	643
8.6 User-defined thermal material laws.	644
8.7 User-defined nonlinear equations	646
8.7.1 Mean rotation MPC.	648
8.7.2 Maximum distance MPC.	650
8.7.3 Network MPC.	651
8.8 User-defined elements	651
8.8.1 Network element	651
9 Programming rules.	652
10 Program structure.	653
10.1 Allocation of the fields	654
10.1.1 openfile	654
10.1.2 readinput	654
10.1.3 allocate	657
10.1.4 restart	664

10.2	Reading the step input data	664
10.2.1	SPC's	664
10.2.2	Homogeneous linear equations	667
10.2.3	Concentrated loads	669
10.2.4	Facial distributed loads	669
10.2.5	Mechanical body loads	671
10.2.6	Distributing coupling loads	672
10.2.7	Sets	674
10.2.8	Material description	675
10.3	Expansion of the one-dimensional and two-dimensional elements	677
10.3.1	Cataloguing the elements belonging to a given node	678
10.3.2	Calculating the normals in the nodes	678
10.3.3	Expanding the 1D and 2D elements	680
10.3.4	Connecting 1D and 2D elements to 3D elements	681
10.3.5	Applying the SPC's to the expanded structure	682
10.3.6	Applying the MPC's to the expanded structure	683
10.3.7	Applying temperatures and temperature gradients	683
10.3.8	Applying concentrated forces to the expanded structure	683
10.3.9	Integrating the stresses in beams to obtain the section forces	684
10.4	Contact	685
10.4.1	Penalty contact	685
10.4.2	Massless contact	700
10.5	Storing distributions for local coordinate systems	702
10.6	Determining the matrix structure	703
10.6.1	Matching the SPC's	703
10.6.2	De-cascading the MPC's	704
10.6.3	Determining the matrix structure.	705
10.7	Filling and solving the set of equations, storing the results	706
10.7.1	Linear static analysis	707
10.7.2	Nonlinear calculations	707
10.7.3	Frequency calculations	711
10.7.4	Buckling calculations	712
10.7.5	Modal dynamic calculations	713
10.7.6	Steady state dynamics calculations	713
10.8	Major routines	714
10.8.1	mafillsm	714
10.8.2	results	715
10.9	Aerodynamic and hydraulic networks	716
10.9.1	The variables and the equations	717
10.9.2	Determining the basic characteristics of the network	719
10.9.3	Initializing the unknowns	720
10.9.4	Calculating the residual and setting up the equation system	721
10.9.5	Convergence criteria	721
10.10	Turbulent Flow in Open Channels	721
10.10.1	Sluice Gate	724
10.10.2	Wear	724

10.10.3	Straight Channel	725
10.10.4	Reservoir	725
10.10.5	Contraction, Enlargement, Step and Fall	726
10.11	Three-Dimensional Navier-Stokes Calculations	727
10.11.1	Renumbering	727
10.11.2	Topological information	728
10.11.3	Determining the structure of the system matrices	728
10.11.4	Initial calculations	731
10.11.5	The left hand sides of the equation systems	731
10.11.6	Determining the time increment	732
10.11.7	Determining the loading	732
10.11.8	Step 1: determining $\Delta \mathbf{V}^*$	732
10.11.9	Step 2: determining the pressure/density correction	733
10.11.10	Step 3: determining the second momentum correction	733
10.11.11	Step 4: determining the energy correction	733
10.11.12	Step 5: determining the turbulence corrections	733
10.11.13	Updating the conservative variables	734
10.11.14	Smoothing the conservative variables for gases	734
10.11.15	Determining the physical variables	734
10.11.16	Application of BC's	734
10.11.17	Calculation of the smoothing field	734
10.11.18	Convergence check	735
10.11.19	Result output	735
10.12	Sensitivity Analysis	735
10.12.1	Preprocessing the sensitivity	736
10.12.2	Processing the sensitivity	742
10.12.3	Postprocessing the sensitivity	747
10.13	Mesh refinement	749
10.13.1	Nodal fields	749
10.13.2	Edge fields	751
10.13.3	Face fields	752
10.13.4	Element fields	754
10.13.5	Mesh refining procedure	756
10.13.6	Modifying the boundary conditions	765
10.14	Crack propagation	771
10.15	Interpolation procedure	781
10.15.1	Tetragulation of the master mesh	782
10.15.2	Nearest point algorithm	782
10.15.3	Tetrahedron containment	784
10.15.4	Finite element containment	784
10.16	List of variables and their meaning	787

1 Introduction.

This is a description of CalculiX CrunchiX. If you have any problems using the program, this document should solve them. If not, send us an E-mail (dhondt@t-online.de). The next sections contain some useful information on how to use CalculiX in parallel, hints about units and golden rules you should always keep in mind before starting an analysis. Section five contains a simple example problems to wet your appetite. Section six is a theoretical section giving some background on the analysis types, elements, materials etc. Then, an overview is given of all the available keywords in alphabetical order, followed by detailed instructions on the format of the input deck. If CalculiX does not run because your input deck has problems, this is the section to look at. Then, there is a section on the user subroutines and a short overview of the program structure. The CalculiX distribution contains a large set of test examples (ccx.2.21.test.tar.bz2). If you try to solve a new kind of problem you haven't dealt with in the past, check these examples. You can also use them to check whether you installed CalculiX correctly (if you do so with the compare script and if you experience problems with some of the examples, please check the comments at the start of the corresponding input deck). Finally, the User's Manual ends with some references used while writing the code.

This manual is not a textbook on finite elements. Indeed, a working knowledge of the Finite Element Method is assumed. For people not familiar with the Finite Element Method, I recommend the book by Zienkiewicz and Taylor [109] for engineering oriented students and the publications by Hughes [37] and Dhondt [23] for mathematically minded readers.

2 How to perform CalculiX calculations in parallel

Nowadays most computers have one socket with several cores, allowing for the calculations to be performed in a parallel way. In CalculiX one can

- create the element stiffness matrices in parallel. No special compilation flag is needed. At execution time the environment variable `OMP_NUM_THREADS` or the environment variable `CCX_NPROC_STIFFNESS` must be set to the number of cores, default is 1. If both are set, `CCX_NPROC_STIFFNESS` takes precedence. The maximum number of cores is detected automatically by CalculiX by using the `sysconf(_SC_NPROCESSORS_CONF)` function. It can be overridden by the user by means of environment variable `NUMBER_OF_CPUS`.

Notice that older GNU-compiler versions (e.g. gcc 4.2.1) may have problems with this parallelization due to the size of the fields to be allocated within each thread (e.g. `s(100,100)` in routine `e_3d.f`). This should not be a problem with the actual compiler version.

- solve the system of equations with the multithreaded version of SPOOLES. To this end
 - the MT-version of SPOOLES must have been compiled. For further information on this topic please consult the SPOOLES documentation
 - CalculiX CrunchiX must have been compiled with the USE_MT flag activated in the Makefile, please consult the README.INSTALL file.
 - at execution time the environment variable OMP_NUM_THREADS must have been set to the number of cores you want to use. In Linux this can be done by “export OMP_NUM_THREADS=n” on the command line, where n is the number of cores. Default is 1. Alternatively, you can set the number of cores using the environment variable CCX_NPROC_EQUATION_SOLVER. If both are set, the latter takes precedence.
- solve the system of equations with the multithreaded version of PARDISO. PARDISO is proprietary. Look at the PARDISO documentation how to link the multithreaded version. At execution time the environment variable OMP_NUM_THREADS must be set to the number of cores, default is 1.
- create material tangent matrices and calculate the stresses at the integration points in parallel. No special compilation flag is needed. At execution time the environment variable OMP_NUM_THREADS or the environment variable CCX_NPROC_RESULTS must be set to the number of cores, default is 1. If both are set, CCX_NPROC_RESULTS takes precedence. The maximum number of cores is detected automatically by CalculiX by using the sysconf(_SC_NPROCESSORS_CONF) function. It can be overridden by the user by means of environment variable NUMBER_OF_CPUS. Notice that if a material user subroutine (Sections 8.5 and 8.6) is used, certain rules have to be complied with in order to allow parallelization. These include (this list is possibly not exhaustive):
 - no save statements
 - no data statements
 - avoid logical variables
 - no write statements
- calculate the viewfactors for thermal radiation computations in parallel. No special compilation flag is needed. At execution time the environment variable OMP_NUM_THREADS or the environment variable CCX_NPROC_VIEWFACTOR must be set to the number of cores, default is 1. If both are set, CCX_NPROC_VIEWFACTOR takes precedence. The maximum number of cores is detected automatically by CalculiX by using the sysconf(_SC_NPROCESSORS_CONF) function. It can be overridden by the user by means of environment variable NUMBER_OF_CPUS.

- perform several operations in CFD calculations (computational fluid dynamics) in parallel. No special compilation flag is needed. At execution time the environment variable `OMP_NUM_THREADS` or the environment variable `CCX_NPROC_CFD` must be set to the number of cores, default is 1. If both are set, `CCX_NPROC_CFD` takes precedence. The maximum number of cores is detected automatically by CalculiX by using the `sysconf(_SC_NPROCESSORS_CONF)` function. It can be overridden by the user by means of environment variable `NUMBER_OF_CPUS`.
- Calculate the magnetic intensity by use of the Biot-Savart law in parallel. No special compilation flag is needed. At execution time the environment variable `OMP_NUM_THREADS` or the environment variable `CCX_NPROC_BIOTSAVART` must be set to the number of cores, default is 1. If both are set, `CCX_NPROC_BIOTSAVART` takes precedence. The maximum number of cores is detected automatically by CalculiX by using the `sysconf(_SC_NPROCESSORS_CONF)` function. It can be overridden by the user by means of environment variable `NUMBER_OF_CPUS`.
- Perform several vector and matrix operations needed by the SLATEC iterative solvers or by ARPACK in parallel. To this end the user must have defined the environment variable `OMP_NUM_THREADS`, and used the `openmp FORTRAN` flag in the Makefile. The parallelization is done in FORTRAN routines using `openmp`. The corresponding lines start with “`c$omp`”. If the `openmp` flag is not used, these lines are interpreted by the compiler as comment lines and no parallelization takes place. Notice that this parallelization only pays off for rather big systems, let’s say 300,000 degrees of freedom for CFD-calculations or 1,000,000 degrees of freedom for mechanical frequency calculations.

Examples:

- For some reason the function `sysconf` does not work on your computer system and leads to a segmentation fault. You can prevent using the function by defining the maximum number of cores explicitly using the `NUMBER_OF_CPUS` environment variable
- You want to perform a thermomechanical calculation, but you are using a user defined material subroutine (Sections 8.5 and 8.6) which is not suitable for parallelization. You can make maximum use of parallelization (e.g. for the calculation of viewfactors) by setting the variable `OMP_NUM_THREADS` to the maximum number of cores on your system, and prevent parallelization of the material tangent and stress calculation step by setting `CCX_NPROC_RESULTS` to 1.

3 Units

An important issue which frequently raises questions concerns units. Finite element programs do not know any units. The user has to take care of that. In

fact, there is only one golden rule: the user must make sure that the numbers he provides have consistent units. The number of units one can freely choose depends on the application. For thermomechanical problems you can choose four units, e.g. for length, mass, time and temperature. If these are chosen, everything else is fixed. If you choose SI units for these quantities, i.e. m for length, kg for mass, s for time and K for temperature, force will be in $\text{kgm/s}^2 = \text{N}$, pressure will be in $\text{N/m}^2 = \text{kg/ms}^2$, density will be in kg/m^3 , thermal conductivity in $\text{W/mK} = \text{J/smK} = \text{Nm/smK} = \text{kgm}^2/\text{s}^3\text{mK} = \text{kgm/s}^3\text{K}$, specific heat in $\text{J/kgK} = \text{Nm/kgK} = \text{m}^2/\text{s}^2\text{K}$ and so on. The density of steel in the SI system is 7800 kg/m^3 .

If you choose mm for length, g for mass, s for time and K for temperature, force will be in gmm/s^2 and thermal conductivity in $\text{gmm/s}^3\text{K}$. In the $\{\text{mm}, \text{g}, \text{s}, \text{K}\}$ system the density of steel is 7.8×10^{-3} since $7800\text{kg/m}^3 = 7800 \times 10^{-6}\text{g/mm}^3$.

However, you can also choose other quantities as the independent ones. A popular system at my company is mm for length, N for force, s for time and K for temperature. Now, since $\text{force} = \text{mass} \times \text{length} / \text{time}^2$, we get that $\text{mass} = \text{force} \times \text{time}^2 / \text{length}$. This leads to Ns^2/mm for the mass and Ns^2/mm^4 for density. This means that in the $\{\text{mm}, \text{N}, \text{s}, \text{K}\}$ system the density of steel is 7.8×10^{-9} since $7800\text{kg/m}^3 = 7800\text{Ns}^2/\text{m}^4 = 7.8 \times 10^{-9}\text{Ns}^2/\text{mm}^4$.

Notice that you are not totally free in choosing the four basic units: you cannot choose the unit of force, mass, length and time as basic units since they are linked with each other through $\text{force} = \text{mass} \times \text{length} / \text{time}^2$.

Finally, a couple of additional examples. Young's Modulus for steel is $210000\text{N/mm}^2 = 210000 \times 10^6\text{N/m}^2 = 210000 \times 10^6\text{kg/ms}^2 = 210000 \times 10^6\text{g/mms}^2$. So its value in the SI system is 210×10^9 , in the $\{\text{mm}, \text{g}, \text{s}, \text{K}\}$ system it is also 210×10^9 and in the $\{\text{mm}, \text{N}, \text{s}, \text{K}\}$ system it is 210×10^3 . The heat capacity of steel is $446\text{J/kgK} = 446\text{m}^2/\text{s}^2\text{K} = 446 \times 10^6\text{mm}^2/\text{s}^2\text{K}$, so in the SI system it is 446., in the $\{\text{mm}, \text{g}, \text{s}, \text{K}\}$ and $\{\text{mm}, \text{N}, \text{s}, \text{K}\}$ system it is 446×10^6 .

Table 1 gives an overview of frequently used units in three different systems: the $\{\text{m}, \text{kg}, \text{s}, \text{K}\}$ system, the $\{\text{mm}, \text{N}, \text{s}, \text{K}\}$ system and the $\{\text{cm}, \text{g}, \text{s}, \text{K}\}$ system.

Typical values for air, water and steel at room temperature are:

- air

- $c_p = 1005 \text{ J/kgK} = 1005 \times 10^6 \text{ mm}^2/\text{s}^2\text{K}$
- $\lambda = 0.0257 \text{ W/mK} = 0.0257 \text{ N/sK}$
- $\mu = 18.21 \times 10^{-6} \text{ kg/ms} = 18.21 \times 10^{-12} \text{ Ns/mm}^2$
- r (specific gas constant) = $287 \text{ J/kgK} = 287 \times 10^6 \text{ mm}^2/\text{s}^2\text{K}$

- water

- $\rho = 1000 \text{ kg/m}^3 = 10^{-9} \text{ Ns}^2/\text{mm}^4$
- $c_p = 4181.8 \text{ J/kgK} = 4181.8 \times 10^6 \text{ mm}^2/\text{s}^2\text{K}$
- $\lambda = 0.5984 \text{ W/mK} = 0.5984 \text{ N/sK}$

Table 1: Frequently used units in different unit systems.

symbol	meaning	m,kg,s,K	mm,N,s,K	cm,g,s,K
E	Young's Modulus	$1 \frac{N}{m^2} = 1 \frac{kg}{m \cdot s^2}$	$= 10^{-6} \frac{N}{mm^2}$	$= 1 \frac{g}{mm \cdot s^2}$
ρ	Density	$1 \frac{kg}{m^3}$	$= 10^{-12} \frac{Ns^2}{mm^4}$	$= 10^{-6} \frac{g}{mm^3}$
F	Force	$1N = 1 \frac{kgm}{s^2}$	$= 1N$	$= 10^6 \frac{g \cdot mm}{s^2}$
c_p	Specific Heat	$1 \frac{J}{kgK} = 1 \frac{m^2}{s^2K}$	$= 10^6 \frac{mm^2}{s^2K}$	$= 10^6 \frac{mm^2}{s^2K}$
λ	Conductivity	$1 \frac{W}{mK} = 1 \frac{kgm}{s^3K}$	$= 1 \frac{N}{sK}$	$= 10^6 \frac{g \cdot mm}{s^3K}$
h	Film Coefficient	$1 \frac{W}{m^2K} = 1 \frac{kg}{s^3K}$	$= 10^{-3} \frac{N}{mm \cdot sK}$	$= 10^3 \frac{g}{s^3K}$
μ	Dynamic Viscosity	$1 \frac{Ns}{m^2} = 1 \frac{kg}{m \cdot s}$	$= 10^{-6} \frac{Ns}{mm^2}$	$= 1 \frac{g}{mm \cdot s}$

$$- \mu = 10^{-3} \text{ Pa s} = 10^{-9} \text{ Ns/mm}^2$$

- steel

$$- E = 210000^6 \text{ N/m}^2 = 210000 \text{ N/mm}^2$$

$$- \nu \text{ (Poisson coefficient)} = 0.3$$

$$- \rho = 7800 \text{ kg/m}^3 = 7.8 \times 10^{-9} \text{ Ns}^2/\text{mm}^4$$

$$- c_p = 446 \text{ J/kgK} = 446 \times 10^6 \text{ mm}^2/\text{s}^2\text{K}$$

$$- \lambda = 50 \text{ W/mK} = 50 \text{ N/sK}$$

4 Golden rules

Applying the finite element method to real-life problems is not always a piece of cake. Especially achieving convergence for nonlinear applications (large deformation, nonlinear material behavior, contact) can be quite tricky. However, adhering to a couple of simple rules can make life a lot easier. According to my experience, the following guidelines are quite helpful:

1. Check the quality of your mesh in CalculiX GraphiX or by using any other good preprocessor.
2. If you are dealing with a nonlinear problem, RUN A LINEARIZED VERSION FIRST: eliminate large deformations (drop NLGEOM), use a linear

elastic material and drop all other nonlinearities such as contact. If the linear version doesn't run, the nonlinear problem won't run either. The linear version allows you to check easily whether the boundary conditions are correct (no unrestrained rigid body modes), the loading is the one you meant to apply etc. Furthermore, you get a feeling what the solution should look like.

3. USE QUADRATIC ELEMENTS (C3D10, C3D15, C3D20(R), S8, CPE8, CPS8, CAX8, B32), except for explicit dynamic calculations. The standard shape functions for quadratic elements are very good. Most finite element programs use these standard functions. For linear elements this is not the case: linear elements exhibit all kind of weird behavior such as shear locking and volumetric locking. Therefore, most finite element programs modify the standard shape functions for linear elements to alleviate these problems. However, there is no standard way of doing this, so each vendor has created his own modifications without necessarily publishing them. This leads to a larger variation in the results if you use linear elements. Since CalculiX uses the standard shape functions for linear elements too, the results must be considered with care.
4. If you are using shell elements or beam elements, use the option OUTPUT=3D on the *NODE FILE card in CalculiX (which is default). That way you get the expanded form of these elements in the .frd file. You can easily verify whether the thicknesses you specified are correct. Furthermore, you get the 3D stress distribution. It is the basis for the 1D/2D stress distribution and the internal beam forces. If the former is incorrect, so will the latter be.
5. If you include contact in your calculations and you are using quadratic elements, use the face-to-face penalty contact method or the mortar method (which is by default a face-to-face method). In general, for contact between faces the face-to-face penalty method and the mortar method will converge much better than the node-to-face method. The type of contact has to be declared on the *CONTACT PAIR card. Notice that the mortar method in CalculiX can only be used for static calculations.
6. If you are performing an explicit dynamic calculation use:
 - linear elements (C3D4, C3D8 or C3D6)
 - node-to-face contact
 - mass scaling: this is activated automatically as soon as you specify a minimum time increment (third entry underneath *DYNAMIC).
7. if you do not have enough space to run a problem, check the numbering. The memory needed to run a problem depends on the largest node and element numbers (the computational time, though, does not). So if you notice large gaps in the numbering, get rid of them and you will need less

memory. In some problems you can save memory by choosing an iterative solution method. The iterative scaling method (cf. *STATIC) needs less memory than the iterative Cholesky method, the latter needs less memory than SPOOLES or PARDISO.

If you experience problems you can:

1. look at the screen output. In particular, the convergence information for nonlinear calculations may indicate the source of your problem.
2. look at the .sta file. This file contains information on the number of iterations needed in each increment to obtain convergence
3. look at the .cvg file. This file is a synopsis of the screen output: it gives you a very fast overview of the number of contact elements, the residual force and the largest change in solution in each iteration (no matter whether convergent or not).
4. use the “last iterations” option on the *NODE FILE or similar card. This generates a file with the name ResultsForLastIterations.frd with the deformation (for mechanical calculations) and the temperature (for thermal calculations) for all non-converged iterations starting after the last convergent increment.
5. if you have contact definitions in your input deck you may use the “contact elements” option on the *NODE FILE or similar card. This generates a file with the name jobname.cel with all contact elements in all iterations of the increment in which this option is active. By reading this file in CalculiX GraphiX you can visualize all contact elements in each iteration and maybe find the source of your problems.
6. if you experience a segmentation fault, you may set the environment variable CCX_LOG_ALLOC to 1 by typing “export CCX_LOG_ALLOC=1” in a terminal window. Running CalculiX you will get information on which fields are allocated, reallocated or freed at which line in the code (default is 0).
7. this is for experts: if you experience problems with dependencies between different equations you can print the SPC’s at the beginning of each step by removing the comment in front of the call to writeboun in ccx_2.21.c and recompile, and you can print the MPC’s each time they are set up by uncommenting the loop in which writempc is called at the beginning of cascade.c and recompile.

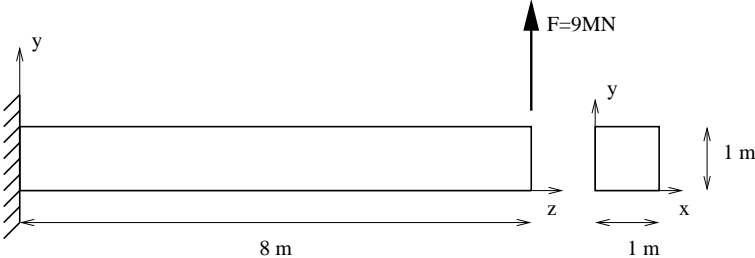

Figure 1: Geometry and boundary conditions of the beam problem

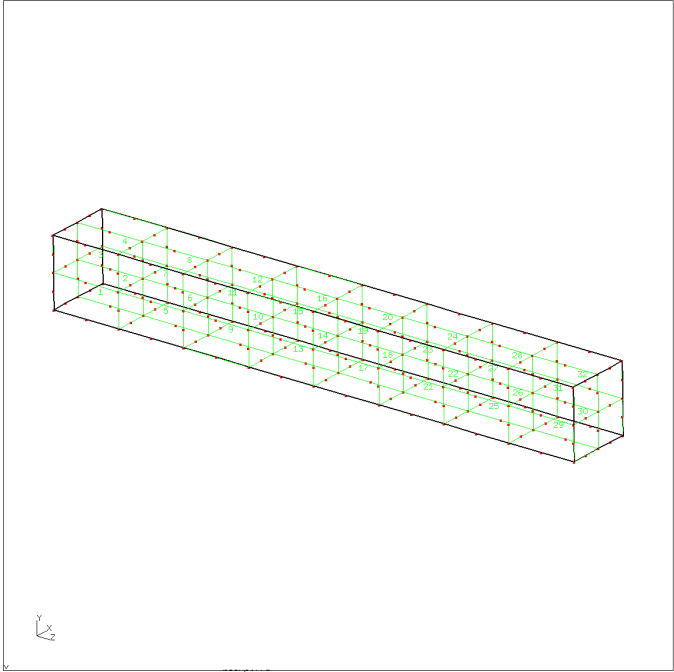

Figure 2: Mesh for the beam

5 Simple example problems

5.1 Cantilever beam

In this section, a cantilever beam loaded by point forces at its free end is analyzed.

The geometry, loading and boundary conditions of the cantilever beam are shown in Figure 1. The size of the beam is $1 \times 1 \times 8 \text{ m}^3$, the loading consists of a point force of $9 \times 10^6 \text{ N}$ and the beam is completely fixed (in all directions) on the left end. Let us take 1 m and 1 MN as units of length and force, respectively. Assume that the beam geometry was generated and meshed with CalculiX GraphiX (cgx) resulting in the mesh in Figure 2. For reasons of clarity, only element labels are displayed.

A CalculiX input deck basically consists of a model definition section describing the geometry and boundary conditions of the problem and one or more steps (Figure 3) defining the loads.

The model definition section starts at the beginning of the file and ends at the occurrence of the first *STEP card. All input is preceded by keyword cards, which all start with an asterisk (*), indicating the kind of data which follows. *STEP is such a keyword card. Most keyword cards are either model definition cards (i.e. they can only occur before the first *STEP card) or step cards (i.e. they can only occur between *STEP and *END STEP cards). A few can be both.

In our example (Figure 4), the first keyword card is *HEADING, followed by a short description of the problem. This has no effect on the output and only serves for identification. Then, the coordinates are given as triplets preceded by the *NODE keyword. Notice that data on the same line are separated by commas and must not exceed a record length of 132 columns. A keyword card can be repeated as often as needed. For instance, each node could have been preceded by its own *NODE keyword card.

Next, the topology is defined by use of the keyword card *ELEMENT. Defining the topology means listing for each element its type, which nodes belong to the element and in what order. The element type is a parameter on the keyword card. In the beam case 20-node brick elements with reduced integration have been used, abbreviated as C3D20R. In addition, by adding ELSET=Eall, all elements following the *ELEMENT card are stored in set Eall. This set will be later referred to in the material definition. Now, each element is listed followed by the 20 node numbers defining it. With *NODE and *ELEMENT, the core of the geometry description is finished. Remaining model definition items are geometric boundary conditions and the material description.

The only geometric boundary condition in the beam problem is the fixation at $z=0$. To this end, the nodes at $z=0$ are collected and stored in node set FIX defined by the keyword card *NSET. The nodes belonging to the set follow on the lines underneath the keyword card. By means of the card *BOUNDARY, the nodes belonging to set FIX are subsequently fixed in 1, 2 and 3-direction, corresponding to x,y and z. The three *BOUNDARY statements in Figure 4

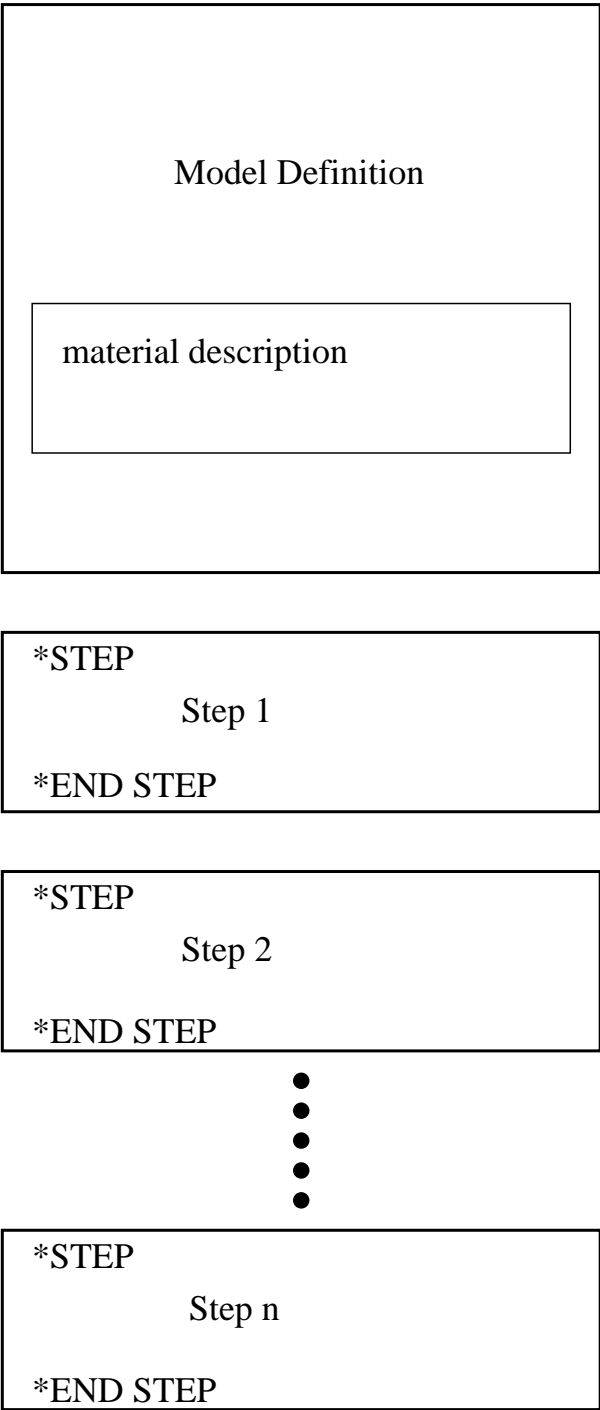

Figure 3: Structure of a CalculiX input deck

```

*HEADING
Model: beam      Date: 10-Mar-1998
*NODE
  1,      0.000000,      0.000000,      0.000000
  2,      1.000000,      0.000000,      0.000000
  3,      1.000000,      1.000000,      0.000000
  .
  .
  .
 260,      0.500000,      0.750000,      7.000000
 261,      0.500000,      0.500000,      7.500000
*ELEMENT, TYPE=C3D20R , ELSET=Eall
  1,      1,      10,      95,      19,      61,      105,      222,      192,      9,      93,
      94,      20,      104,      220,      221,      193,      62,      103,      219,      190
  2,      10,      2,      13,      95,      105,      34,      134,      222,      11,      12,
      96,      93,      106,      133,      223,      220,      103,      33,      132,      219
  .
  .
  .
 32,      258,      158,      76,      187,      100,      25,      7,      28,      259,      159,
      186,      260,      101,      26,      27,      102,      261,      160,      77,      189
*NSET, NSET=FIX
  97,      96,      95,      94,      93,      20,      19,      18,      17,      16,      15,
  14,      13,      12,      11,      10,      9,      4,      3,      2,      1
*BOUNDARY
FIX, 1
*BOUNDARY
FIX, 2
*BOUNDARY
FIX, 3
*NSET,NSET=Nall,GENERATE
1,261
*MATERIAL,NAME=EL
*ELASTIC
  210000.0,      .3
*SOLID SECTION,ELSET=Eall,MATERIAL=EL
*NSET,NSET=LOAD
5,6,7,8,22,25,28,31,100
**
*STEP
*STATIC
*CLOAD
LOAD,2,1.
*NODE PRINT,NSET=Nall
U
*EL PRINT,ELSET=Eall
S
*NODE FILE
U
*EL FILE
S
*END STEP

```

Figure 4: Beam input deck

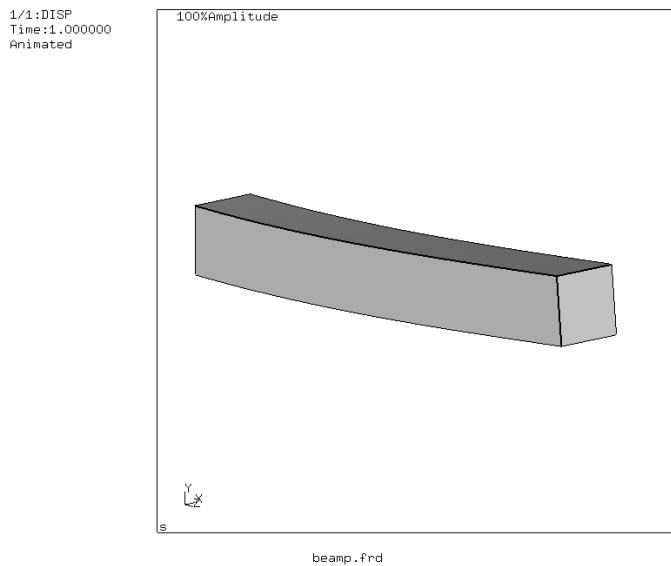

Figure 5: Deformation of the beam

can actually be grouped yielding:

```
*BOUNDARY
FIX,1
FIX,2
FIX,3
```

or even shorter:

```
*BOUNDARY
FIX,1,3
```

meaning that degrees of freedom 1 through 3 are to be fixed (i.e. set to zero).

The next section in the input deck is the material description. This section is special since the cards describing one and the same material must be grouped together, although the section itself can occur anywhere before the first `*STEP` card. A material section is always started by a `*MATERIAL` card defining the name of the material by means of the parameter `NAME`. Depending on the kind of material several keyword cards can follow. Here, the material is linear elastic, characterized by a Young's modulus of $210,000.0 \text{ MN}/\text{m}^2$ and a Poisson coefficient of 0.3 (steel). These properties are stored beneath the `*ELASTIC` keyword card, which here concludes the material definition. Next, the material is assigned to the element set `Eall` by means of the keyword card `*SOLID SECTION`.

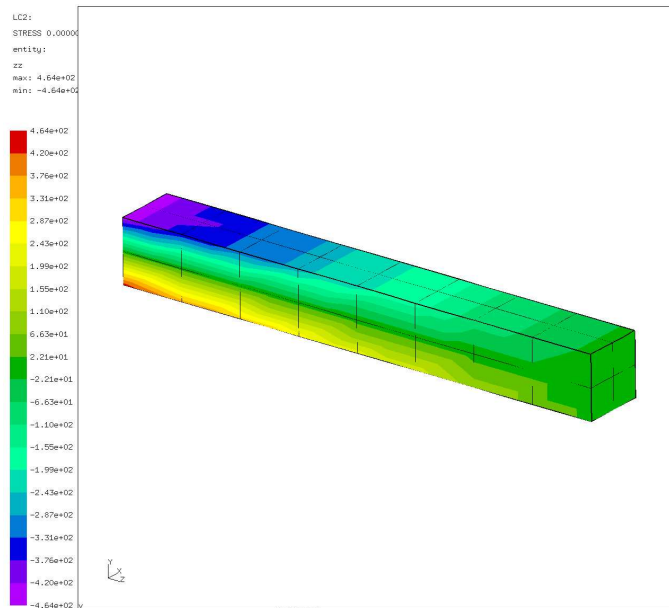

Figure 6: Axial normal stresses in the beam

Finally, the last card in the model definition section defines a node set `LOAD` which will be needed to define the load. The card starting with two asterisks in between the model definition section and the first step section is a comment line. A comment line can be introduced at any place. It is completely ignored by CalculiX and serves for input deck clarity only.

In the present problem, only one step is needed. A step always starts with a `*STEP` card and concludes with a `*END STEP` card. The keyword card `*STATIC` defines the procedure. The `*STATIC` card indicates that the load is applied in a quasi-static way, i.e. so slow that mass inertia does not play a role. Other procedures are `*FREQUENCY`, `*BUCKLE`, `*MODAL DYNAMIC`, `*STEADY STATE DYNAMICS` and `*DYNAMIC`. Next, the concentrated load is applied (keyword `*CLOAD`) to node set `LOAD`. The forces act in y -direction and their magnitude is 1, yielding a total load of 9.

Finally, the printing and file storage cards allow for user-directed output generation. The print cards (`*NODE PRINT` and `*EL PRINT`) lead to an ASCII file with extension `.dat`. If they are not selected, no `.dat` file is generated. The `*NODE PRINT` and `*EL PRINT` cards must be followed by the node and element sets for which output is required, respectively. Element information is stored at the integration points.

The `*NODE FILE` and `*EL FILE` cards, on the other hand, govern the output written to an ASCII file with extension `.frd`. The results in this file can be viewed with CalculiX GraphiX (`cgx`). Quantities selected by the `*NODE`

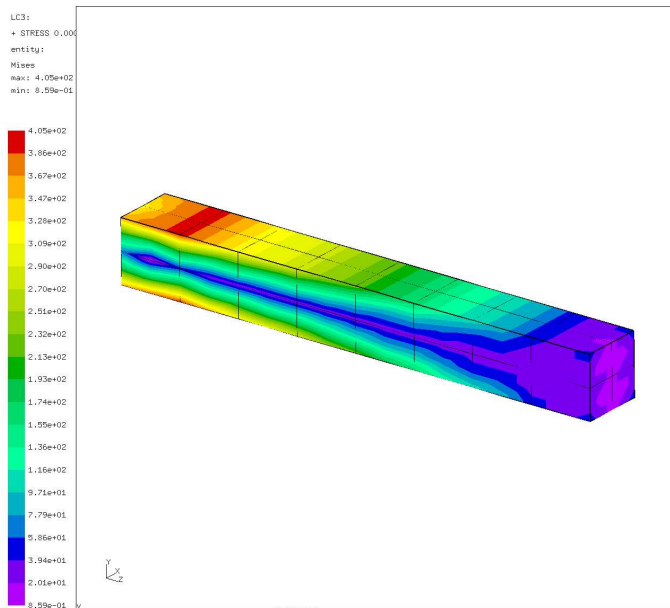

Figure 7: Von Mises stresses in the beam

FILE and *EL FILE cards are always stored for the complete model. Element quantities are extrapolated to the nodes, and all contributions in the same node are averaged. Selection of fields for the *NODE PRINT, *EL PRINT, *NODE FILE and *EL FILE cards is made by character codes: for instance, U are the displacements and S are the (Cauchy) stresses.

The input deck is concluded with an *END STEP card.

The output files for the beam problem consist of file beam.dat and beam.frd. The beam.dat file contains the displacements for set Nall and the stresses in the integration points for set Eall. The file beam.frd contains the displacements and extrapolated stresses in all nodes. It is the input for the visualization program CalculiX GraphiX (cgx). An impression of the capabilities of cgx can be obtained by looking at Figures 5, 6 and 7.

Figure 5 shows the deformation of the beam under the prevailing loads. As expected, the beam bends due to the lateral force at its end. Figure 6 shows the normal stress in axial direction. Due to the bending moment one obtains a nearly linear distribution across the height of the beam. Finally, Figure 7 shows the Von Mises stress in the beam.

5.2 Frequency calculation of a beam loaded by compressive forces

Let us consider the beam from the previous section and determine its eigenfrequencies and eigenmodes. To obtain different frequencies for the lateral directions the cross section is changed from 1x1 to 1x1.5. Its length is kept (8 length units). The input deck is very similar to the one in the previous section (the full deck is part of the test example suite: beamf2.inp):

```

**
**   Structure: beam under compressive forces.
**   Test objective: Frequency analysis; the forces are that
**                   high that the lowest frequency is nearly
**                   zero, i.e. the buckling load is reached.
**
*HEADING
Model: beam      Date: 10-Mar-1998
*NODE
    1,          0.000000,          0.000000,          0.000000
    ...
*ELEMENT, TYPE=C3D20R
    1,          1,          10,          95,          19,          61,          105,          222,          192,          9,          93,
          94,          20,          104,          220,          221,          193,          62,          103,          219,          190
    ...
*BOUNDARY
CN7, 1
*BOUNDARY
CN7, 2
*BOUNDARY
CN7, 3
*ELSET,ELSET=EALL,GENERATE
1,32
*MATERIAL,NAME=EL
*ELASTIC
    210000.0,          .3
*DENSITY
7.8E-9
*SOLID SECTION,MATERIAL=EL,ELSET=EALL
*NSET,NSET=LAST
    5,
    6,
    ...
*STEP
*STATIC
*CLOAD
LAST,3,-48.155

```

```

*END STEP
*STEP,PERTURBATION
*FREQUENCY
10
*NODE FILE
U
*EL FILE
S
*END STEP

```

The only significant differences relate to the steps. In the first step the preload is applied in the form of compressive forces at the end of the beam. In each node belonging to set LAST a compressive force is applied with a value of -48.155 in the positive z-direction, or, which is equivalent, with magnitude 48.155 in the negative z-direction. The second step is a frequency step. By using the parameter PERTURBATION on the *STEP keyword card the user specifies that the deformation and stress from the previous static step should be taken into account in the subsequent frequency calculation. The *FREQUENCY card and the line underneath indicate that this is a modal analysis step and that the 10 lowest eigenfrequencies are to be determined. They are automatically stored in the .dat file. Table 2 shows these eigenfrequencies for the beam without and with preload together with a comparison with ABAQUS (the input deck for the modal analysis without preload is stored in file beamf.inp of the test example suite). One notices that due to the preload the eigenfrequencies drop. This is especially outspoken for the lower frequencies. As a matter of fact, the lowest bending eigenfrequency is so low that buckling will occur. Indeed, one way of determining the buckling load is by increasing the compressive load up to the point that the lowest eigenfrequency is zero. For the present example this means that the buckling load is $21 \times 48.155 = 1011.3$ force units (the factor 21 stems from the fact that the same load is applied in 21 nodes). An alternative way of determining the buckling load is to use the *BUCKLE keyword card. This is illustrated for the same beam geometry in file beamb.inp of the test suite.

Figures 8 and 9 show the deformation of the second bending mode across the minor axis of inertia and deformation of the first torsion mode.

5.3 Frequency calculation of a rotating disk on a slender shaft

```

**
**   Structure: slender disk mounted on a long axis
**   Test objective: *COMPLEX FREQUENCY,
**                   output of moments of inertia.
**
*NODE, NSET=Na11
1,6.123233995737e-17,1.000000000000e+00,0.000000000000e+00

```

Table 2: Frequencies without and with preload (cycles/s).

without preload		with preload	
CalculiX	ABAQUS	CalculiX	ABAQUS
13,096.	13,096.	705.	1,780.
19,320.	19,319.	14,614.	14,822.
76,840.	76,834.	69,731.	70,411.
86,955.	86,954.	86,544.	86,870.
105,964.	105,956.	101,291.	102,148.
162,999.	162,998.	162,209.	163,668.
197,645.	197,540.	191,581.	193,065.
256,161.	256,029.	251,858.	253,603.
261,140.	261,086.	259,905.	260,837.
351,862.	351,197.	345,729.	347,688.

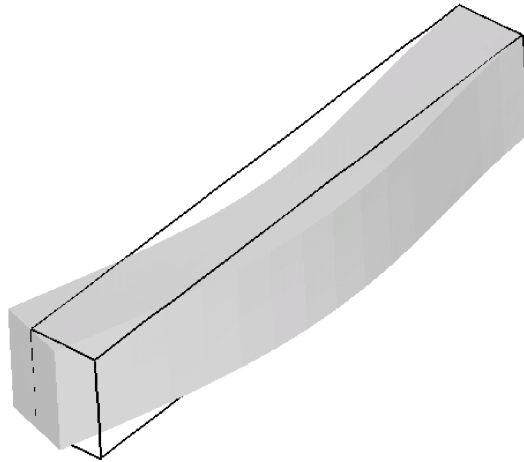

Figure 8: Second bending mode across the minor axis of inertia



Figure 9: First torsion mode

```

...
*ELEMENT, TYPE=C3D20R, ELSET=Eall
    1,      1,      2,      3,      4,      5,      6,      7,      8,      9,      10,
      11,     12,     17,     18,     19,     20,     13,     14,     15,     16
...
*BOUNDARY
Nfix,1,3
*Solid Section, elset=Eall, material=steel
*Material, name=STEEL
*Elastic
    210000., 0.3
*DENSITY
7.8e-9
*Step,nlgeom
*Static
*dload
Eall,centrif,3.0853e8,0.,0.,0.,0.,0.,1.
*end step
*step,perturbation
*frequency,STORAGE=YES
    10,
*end step
*step,perturbation
*complex frequency,coriolis

```

```

10,
*node file
pu
*end step

```

This is an example for a complex frequency calculation. A disk with an outer diameter of 10, an inner diameter of 2 and a thickness of 0.25 is mounted on a hollow shaft with outer diameter 2 and inner diameter 1 (example rotor.inp in het test examples). The disk is mounted in the middle of the shaft, the ends of which are fixed in all directions. The length of the shaft on either side of the disk is 50. The input deck for this example is shown above.

The deck starts with the definition of the nodes and elements. The set Nfix contains the nodes at the end of the shaft, which are fixed in all directions. The material is ordinary steel. Notice that the density is needed for the centrifugal loading.

Since the disk is rotating there is a preload in the form of centrifugal forces. Therefore, the first step is a nonlinear geometric static step in order to calculate the deformation and stresses due to this loading. By selecting the parameter perturbation in the subsequent frequency step this preload is taken into account in the calculation of the stiffness matrix in the frequency calculation. The resulting eigenfrequencies are stored at the top of file rotor.dat (Figure 10 for a rotational speed of 9000 rad/s). In a *FREQUENCY step an eigenvalue problem is solved, the eigenvalues of which (first column on the top of Figure 10) are the square of the eigenfrequencies of the structure (second to fourth column). If the eigenvalue is negative, an imaginary eigenfrequency results. This is the case for the two lowest eigenvalues for the rotor rotating at 9000 rad/s. For shaft speeds underneath about 6000 rad/s all eigenfrequencies are real. The lowest eigenfrequencies as a function of rotating speeds up to 18000 rad/s are shown in Figure 11 (+ and x curves).

What is the physical meaning of imaginary eigenfrequencies? The eigenmodes resulting from a frequency calculation contain the term $e^{i\omega t}$. If the eigenfrequency ω is real, one obtains a sine or cosine, if ω is imaginary, one obtains an increasing or decreasing exponential function [23]. Thus, for imaginary eigenfrequencies the response is not any more oscillatory: it increases indefinitely, the system breaks apart. Looking at Figure 11 one observes that the lowest eigenfrequency decreases for increasing shaft speed up to the point where it is about zero at a shaft speed of nearly 6000 rad/s. At that point the eigenfrequency becomes imaginary, the rotor breaks apart. This has puzzled engineers for a long time, since real systems were observed to reach supercritical speeds without breaking apart.

The essential point here is to observe that the calculations are being performed in a rotating coordinate system (fixed to the shaft). Newton's laws are not valid in an accelerating reference system, and a rotating coordinate system is accelerating. A correction term to Newton's laws is necessary in the form of a Coriolis force. The introduction of the Coriolis force leads to a complex nonlinear eigenvalue system, which can be solved with the *COMPLEX FREQUENCY

```

E I G E N V A L U E   O U T P U T
MODE NO      EIGENVALUE
              REAL PART      FREQUENCY
              (RAD/TIME)     (CYCLES/TIME)
              IMAGINARY PART
                              (RAD/TIME)
1  -0.4710377E+08  0.0000000E+00  0.0000000E+00  0.6863218E+04
2  -0.4710377E+08  0.0000000E+00  0.0000000E+00  0.6863218E+04
3  0.2240062E+09  0.1496684E+05  0.2382046E+04  0.0000000E+00
4  0.2240062E+09  0.1496684E+05  0.2382046E+04  0.0000000E+00
5  0.9466374E+09  0.3076747E+05  0.4896795E+04  0.0000000E+00
6  0.9466374E+09  0.3076747E+05  0.4896795E+04  0.0000000E+00
7  0.2028547E+10  0.4503940E+05  0.7168243E+04  0.0000000E+00
8  0.2930439E+10  0.5413353E+05  0.8615618E+04  0.0000000E+00
9  0.2930439E+10  0.5413353E+05  0.8615618E+04  0.0000000E+00
10 0.5367484E+10  0.7326312E+05  0.1166019E+05  0.0000000E+00

E I G E N V A L U E   O U T P U T
MODE NO      EIGENVALUE
              REAL PART      FREQUENCY
              (RAD/TIME)     (CYCLES/TIME)
              IMAGINARY PART
                              (RAD/TIME)
1  0.3179491E+04  0.5060316E+03  0.3031618E-03
2  0.8499901E+04  0.1352801E+04  -0.2864205E-04
3  0.1481488E+05  0.2357861E+04  -0.1108269E-02
4  0.2307301E+05  0.3672184E+04  -0.3240550E-04
5  0.2634670E+05  0.4193207E+04  0.1973187E-04
6  0.4102791E+05  0.6529794E+04  0.8690869E-04
7  0.4503940E+05  0.7168244E+04  0.2343947E-06
8  0.4649931E+05  0.7400595E+04  0.6623206E-04
9  0.6262165E+05  0.9966545E+04  0.5469548E-04
10 0.7375084E+05  0.1173781E+05  0.2650943E-05

```

Figure 10: Eigenfrequencies for the rotor

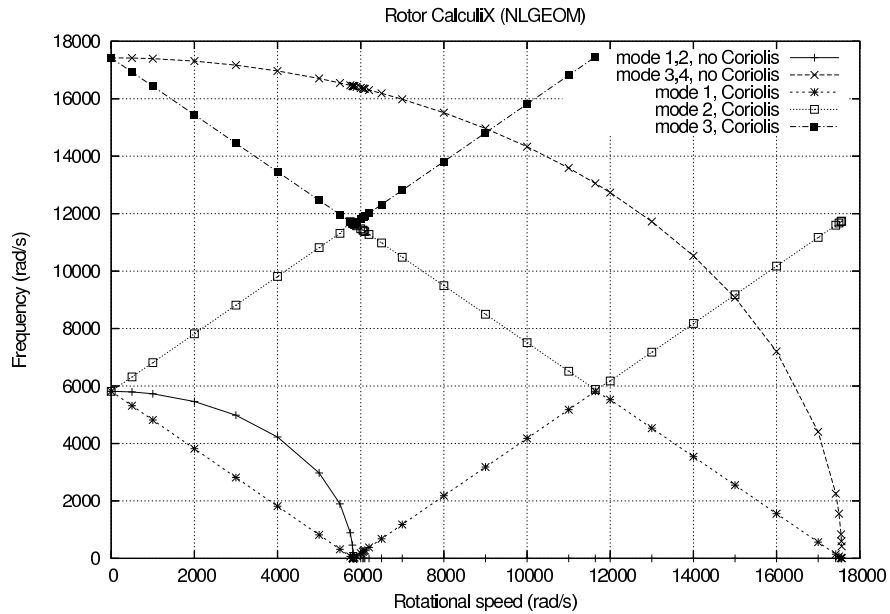

Figure 11: Eigenfrequencies as a function of shaft speed

procedure (cf. Section 6.9.3). One can prove that the resulting eigenfrequencies are real, the eigenmodes, however, are usually complex. This leads to rotating eigenmodes.

In order to use the *COMPLEX FREQUENCY procedure the eigenmodes without Coriolis force must have been calculated and stored in a previous *FREQUENCY step (STORAGE=YES) (cf. Input Deck). The complex frequency response is calculated as a linear combination of these eigenmodes. The number of eigenfrequencies requested in the *COMPLEX FREQUENCY step should not exceed those of the preceding *FREQUENCY step. Since the eigenmodes are complex, they are best stored in terms of amplitude and phase with PU underneath the *NODE FILE card.

The correct eigenvalues for the rotating shaft lead to the straight lines in Figure 11. Each line represents an eigenmode: the lowest decreasing line is a two-node counter clockwise (ccw) eigenmode when looking in (-z)-direction, the highest decreasing line is a three-node ccw eigenmode, the lowest and highest increasing lines constitute both a two-node clockwise (cw) eigenmode. A node is a location at which the radial motion is zero. Figure 12 shows the two-node eigenmode, Figure 13 the three-node eigenmode. Notice that if the scales on the x- and y-axis in Figure 11 were the same the lines would be under 45° .

It might surprise that both increasing straight lines correspond to one and the same eigenmode. For instance, for a shaft speed of 5816 rad/s one and the same eigenmode occurs at an eigenfrequency of 0 and 11632 rad/s. Remember, however, that the eigenmodes are calculated in the rotating system, i.e. as

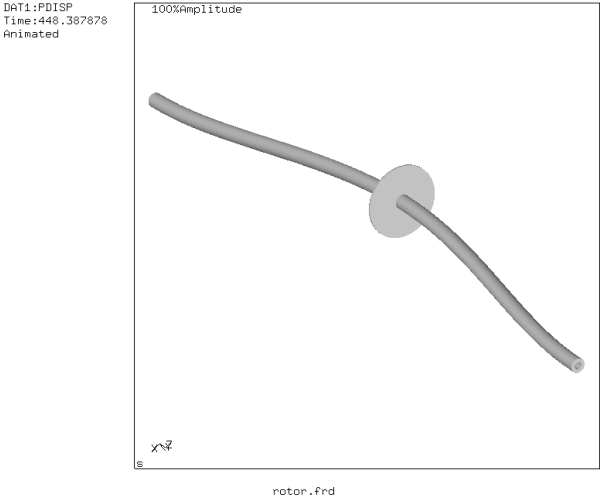

Figure 12: Two-node eigenmode

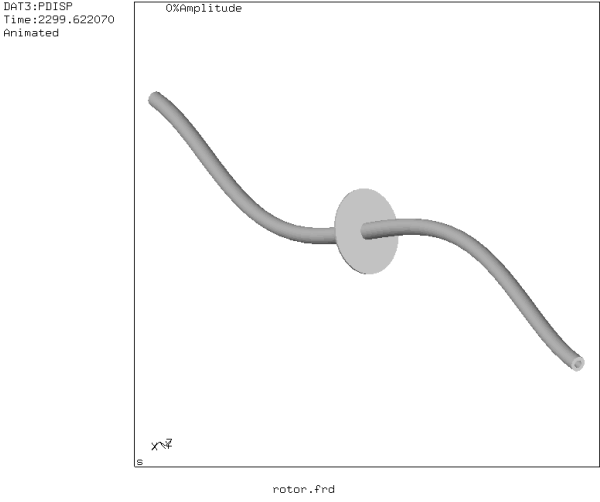

Figure 13: Three-node eigenmode

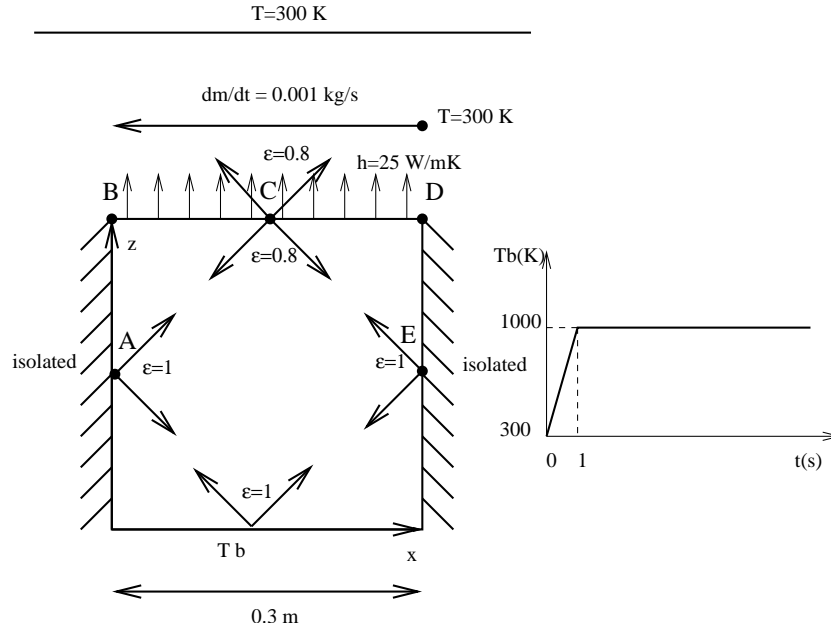

Figure 14: Description of the furnace

observed by an observer rotating with the shaft. To obtain the frequencies for a fixed observer the frequencies have to be considered relative to a 45° straight line through the origin and bisecting the diagram. This observer will see one and the same eigenmode at 5816 rad/s and -5816 rad/s , so cw and ccw.

Finally, the Coriolis effect is not always relevant. Generally, slender rotating structures (large blades...) will exhibit important frequency shifts due to Coriolis.

5.4 Thermal calculation of a furnace

This problem involves a thermal calculation of the furnace depicted in Figure 14. The furnace consists of a bottom plate at a temperature T_b , which is prescribed. It changes linearly in an extremely short time from 300 K to 1000 K after which it remains constant. The side walls of the furnace are isolated from the outer world, but exchange heat through radiation with the other walls of the furnace. The emissivity of the side walls and bottom is $\epsilon = 1$. The top of the furnace exchanges heat through radiation with the other walls and with the environmental temperature which is fixed at 300 K. The emissivity of the top is $\epsilon = 0.8$. Furthermore, the top exchanges heat through convection with a fluid (air) moving at the constant rate of 0.001 kg/s. The temperature of the fluid at the right upper corner is 300 K. The walls of the oven are made of 10 cm steel. The material constants for steels are: heat conductivity $\kappa = 50\text{ W/mK}$, specific heat $c = 446\text{ W/kgK}$ and density $\rho = 7800\text{ kg/m}^3$. The material constants

for air are : specific heat $c_p = 1000\text{W/kgK}$ and density $\rho = 1\text{kg/m}^3$. The convection coefficient is $h = 25\text{W/m}^2\text{K}$. The dimensions of the furnace are $0.3 \times 0.3 \times 0.3\text{m}^3$ (cube). At $t = 0$ all parts are at $T = 300\text{K}$. We would like to know the temperature at locations A,B,C,D and E as a function of time.

```

**
**   Structure: furnace.
**   Test objective: shell elements with convection and radiation.
**
*NODE, NSET=Nall
      1,  3.00000e-01,  3.72529e-09,  3.72529e-09
      ...
*ELEMENT, TYPE=S6, ELSET=furnace
      1,      1,      2,      3,      4,      5,      6
      ...
*ELEMENT, TYPE=D, ELSET=EGAS
301,603,609,604
...
*NSET, NSET=NGAS, GENERATE
603,608
*NSET, NSET=Ndown
1,
...
*PHYSICAL CONSTANTS, ABSOLUTE ZERO=0., STEFAN BOLTZMANN=5.669E-8
*MATERIAL, NAME=STEEL
*DENSITY
7800.
*CONDUCTIVITY
50.
*SPECIFIC HEAT
446.
*SHELL SECTION, ELSET=furnace, MATERIAL=STEEL
0.01
*MATERIAL, NAME=GAS
*DENSITY
1.
*SPECIFIC HEAT
1000.
*FLUID SECTION, ELSET=EGAS, MATERIAL=GAS
*INITIAL CONDITIONS, TYPE=TEMPERATURE
Nall,300.
*AMPLITUDE, NAME=A1
0.,.3,1.,1.
*STEP, INC=100
*HEAT TRANSFER
0.1,1.

```

```

*VIEWFACTOR,WRITE
*BOUNDARY,AMPLITUDE=A1
Ndown,11,11,1000.
*BOUNDARY
603,11,11,300.
*BOUNDARY,MASS FLOW
609,1,1,0.001
...
*RADIATE
** Radiate based on down
1, R1CR,1000., 1.000000e+00
...
** Radiate based on top
51, R1CR,1000., 8.000000e-01
...
** Radiate based on side
101, R1CR,1000., 1.000000e+00
...
** Radiate based on top
51, R2,300., 8.000000e-01
...
*FILM
51, F2FC, 604, 2.500000e+01
...
*NODE FILE
NT
*NODE PRINT,NSET=NGAS
NT
*END STEP

```

The input deck is listed above. It starts with the node definitions. The highest node number in the structure is 602. The nodes 603 up to 608 are fluid nodes, i.e. in the fluid extra nodes were defined ($z=0.3$ corresponds with the top of the furnace, $z=0$ with the bottom). Fluid node 603 corresponds to the location where the fluid temperature is 300 K (“inlet”), node 608 corresponds to the “outlet”, the other nodes are located in between. The coordinates of the fluid nodes actually do not enter the calculations. Only the convective definitions with the keyword *FILM govern the exchange between furnace and fluid. With the *ELEMENT card the 6-node shell elements making up the furnace walls are defined. Furthermore, the fluid nodes are also assigned to elements (element type D), so-called network elements. These elements are needed for the assignment of material properties to the fluid. Indeed, traditionally material properties are assigned to elements and not to nodes. Each network element consists of two end nodes, in which the temperature is unknown, and a midside node, which is used to define the mass flow rate through the element. The fluid

nodes 603 up to 613 are assigned to the network elements 301 up to 305.

Next, two node sets are defined: GAS contains all fluid nodes, Ndown contains all nodes on the bottom of the furnace.

The *PHYSICAL CONSTANTS card is needed in those analyses in which radiation plays a role. It defines absolute zero, here 0 since we work in Kelvin, and the Stefan Boltzmann constant. In the present input deck SI units are used throughout.

Next, the material constants for STEEL are defined. For thermal analyses the conductivity, specific heat and density must be defined. The *SHELL SECTION card assigns the STEEL material to the element set FURNACE, defined by the *ELEMENT statement before. It contains all elements belonging to the furnace. Furthermore, a thickness of 0.01 m is assigned.

The material constants for material GAS consist of the density and the specific heat. These are the constants for the fluid. Conduction in the fluid is not considered. The material GAS is assigned to element set EGAS containing all network elements.

The *INITIAL CONDITIONS card defines an initial temperature of 300 K for all nodes, i.e. furnace nodes AND fluid nodes. The *AMPLITUDE card defines a ramp function starting at 0.3 at 0.0 and increasing linearly to 1.0 at 1.0. It will be used to define the temperature boundary conditions at the bottom of the furnace. This ends the model definition.

The first step describes the linear increase of the temperature boundary condition between $t = 0$ and $t = 1$. The INC=100 parameter on the *STEP card allows for 100 increments in this step. The procedure is *HEAT TRANSFER, i.e. we would like to perform a purely thermal analysis: the only unknowns are the temperature and there are no mechanical unknowns (e.g. displacements). The step time is 1., the initial increment size is 0.1. Both appear on the line underneath the *HEAT TRANSFER card. The absence of the parameter STEADY STATE on the *HEAT TRANSFER card indicates that this is a transient analysis.

Next come the temperature boundary conditions: the bottom plate of the furnace is kept at 1000 K, but is modulated by amplitude A1. The result is that the temperature boundary condition starts at $0.3 \times 1000 = 300\text{K}$ and increases linearly to reach 1000 K at $t=1$ s. The second boundary conditions specifies that the temperature of (fluid) node 603 is kept at 300 K. This is the inlet temperature. Notice that “11” is the temperature degree of freedom.

The mass flow rate in the fluid is defined with the *BOUNDARY card applied to the first degree of freedom of the midside nodes of the network elements. The first line tells us that the mass flow rate in (fluid)node 609 is 0.001. Node 609 is the midside node of network element 301. Since this rate is positive the fluid flows from node 603 towards node 604, i.e. from the first node of network element 301 to the third node. The user must assure conservation of mass (this is actually also checked by the program).

The first set of radiation boundary conditions specifies that the top face of the bottom of the furnace radiates through cavity radiation with an emissivity of 1 and an environment temperature of 1000 K. For cavity radiation the envi-

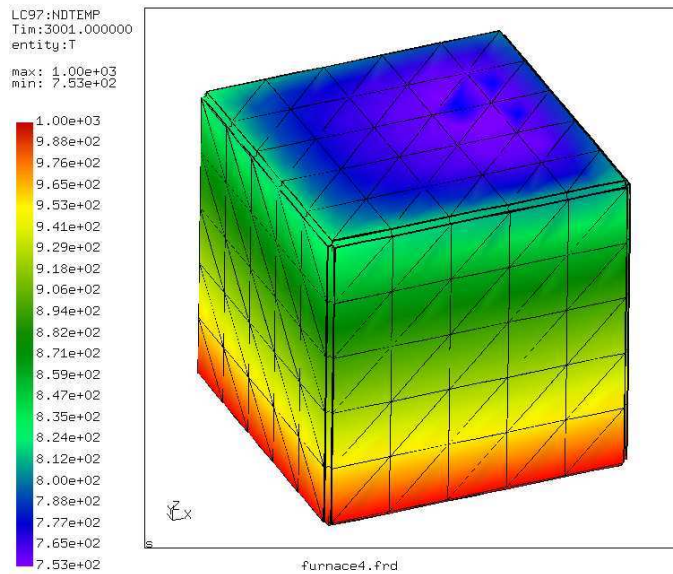

Figure 15: Temperature distribution at $t=3001$ s

ronment temperature is used in case the viewfactor at some location does not amount to 1. What is short of 1 radiates towards the environment. The first number in each line is the element, the number in the label (the second entry in each line) is the face of the element exposed to radiation. In general, these lines are generated automatically in cgx (CalculiX GraphiX).

The second and third block define the internal cavity radiation in the furnace for the top and the sides. The fourth block defines the radiation of the top face of the top plate of the furnace towards the environment, which is kept at 300 K. The emissivity of the top plate is 0.8.

Next come the film conditions. Forced convection is defined for the top face of the top plate of the furnace with a convection coefficient $h = 25\text{W/mK}$. The first line underneath the *FILM keyword indicates that the second face of element 51 interacts through forced convection with (fluid)node 604. The last entry in this line is the convection coefficient. So for each face interacting with the fluid an appropriate fluid node must be specified with which the interaction takes place.

Finally, the *NODE FILE card makes sure that the temperature is stored in the .frd file and the *NODE PRINT card takes care that the fluid temperature is stored in the .dat file.

The complete input deck is part of the test examples of CalculiX (furnace.inp). For the present analysis a second step was appended keeping the bottom temperature constant for an additional 3000 seconds.

What happens during the calculation? The walls and top of the furnace heat

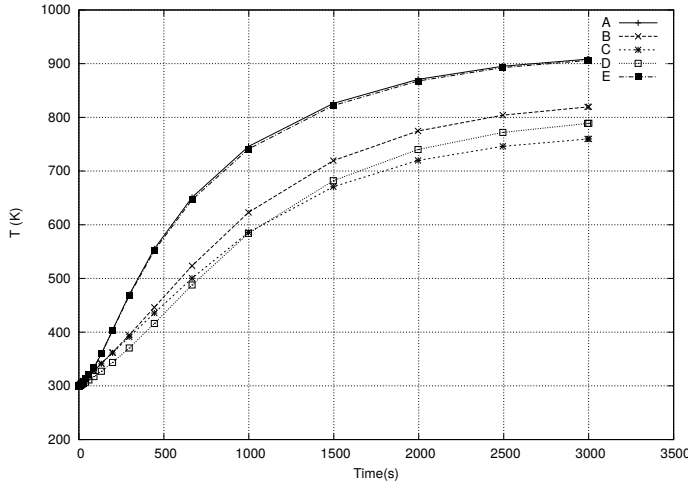

Figure 16: Temperature at selected positions

up due to conduction in the walls and radiation from the bottom. However, the top of the furnace also loses heat through radiation with the environment and convection with the fluid. Due to the interaction with the fluid the temperature is asymmetric: at the inlet the fluid is cool and the furnace will lose more heat than at the outlet, where the temperature of the fluid is higher and the temperature difference with the furnace is smaller. So due to convection we expect a temperature increase from inlet to outlet. Due to conduction we expect a temperature minimum in the middle of the top. Both effects are superimposed. The temperature distribution at $t = 3001$ s is shown in Figure 15. There is a temperature gradient from the bottom of the furnace towards the top. At the top the temperature is indeed not symmetric. This is also shown in Figure 16, where the temperature of locations A, B, C, D and E is plotted as a function of time.

Notice that steady state conditions have not been reached yet. Also note that 2D elements (such as shell elements) are automatically expanded into 3D elements with the right thickness. Therefore, the pictures, which were plotted from within CalculiX GraphiX, show 3D elements.

5.5 Seepage under a dam

In this section, groundwater flow under a dam is analyzed. The geometry of the dam is depicted in Figure 17 and is taken from exercise 30 in Chapter 1 of [32]. All length measurements are in feet (0.3048 m). The water level upstream of the dam is 20 feet high, on the downstream side it is 5 feet high. The soil underneath the dam is anisotropic. Upstream the permeability is characterized by $k_1 = 4k_2 = 10^{-2}$ cm/s, downstream we have $25k_3 = 100k_4 = 10^{-2}$ cm/s. Our primary interest is the hydraulic gradient, i.e. ∇h since this is a measure

whether or not piping will occur. Piping means that the soil is being carried away by the groundwater flow (usually at the downstream side) and constitutes an instable condition. As a rule of thumb, piping will occur if the hydraulic gradient is about unity.

From Section 6.9.14 we know that the equations governing stationary groundwater flow are the same as the heat equations. The equivalent quantity of the total head is the temperature and of the velocity it is the heat flow. For the finite element analysis SI units were taken, so feet was converted into meter. Furthermore, a vertical impermeable wall was assumed far upstream and far downstream (actually, 30 m upstream from the middle point of the dam and 30 m downstream).

Now, the boundary conditions are:

1. the dam, the left and right vertical boundaries upstream and downstream, and the horizontal limit at the bottom are impermeable. This means that the water velocity perpendicular to these boundaries is zero, or, equivalently, the heat flux.
2. taking the reference for the z-coordinate in the definition of total head at the bottom of the dam (see Equation 583 for the definition of total head), and assuming that the atmospheric pressure p_0 is zero, the total head upstream is 28 feet and downstream it is 13 feet. In the thermal equivalent this corresponds to temperature boundary conditions.

The input deck is summarized in Figure 18. The complete deck is part of the example problems. The problem is really two-dimensional and consequently qu8 elements were used for the mesh generation within CalculiX GraphiX. To obtain a higher resolution immediately adjacent to the dam a bias was used (the mesh can be seen in Figure 19).

At the start of the deck the nodes are defined and the topology of the elements. The qu8 element type in CalculiX GraphiX is by default translated by the send command into a S8 (shell) element in CalculiX CrunchiX. However, a plane element is here more appropriate. Since the calculation at stake is thermal and not mechanical, it is really immaterial whether one takes plane strain (CPE8) or plane stress (CPS8) elements. With the *ELSET keyword the element sets for the two different kinds of soil are defined. The nodes on which the constant total head is to be applied are defined by *NSET cards. The permeability of the soil corresponds to the heat conduction coefficient in a thermal analysis. Notice that the permeability is defined to be orthotropic, using the *CONDUCTIVITY,TYPE=ORTHO card. The values beneath this card are the permeability in x, y and z-direction (SI units: m/s). The value for the z-direction is actually immaterial, since no gradient is expected in that direction. The *SOLID SECTION card is used to assign the materials to the appropriate soil regions. The *INITIAL CONDITIONS card is not really needed, since the calculation is stationary, however, CalculiX CrunchiX formally needs it in a heat transfer calculation.

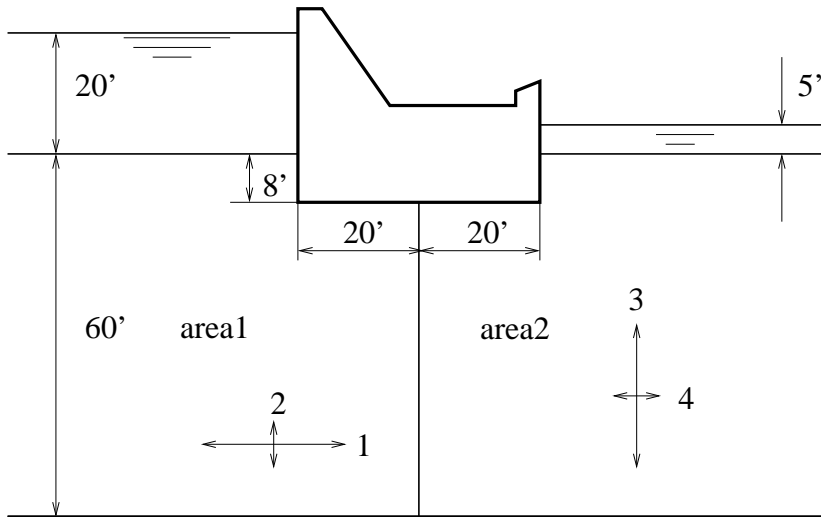

Figure 17: Geometry of the dam

Within the step a `*HEAT TRANSFER, STEADY STATE` calculation is selected without any additional time step information. This means that the defaults for the step length (1) and initial increment size (1) will be taken. With the `*BOUNDARY` cards the total head upstream and downstream is defined (11 is the temperature degree of freedom). Finally, the `*NODE PRINT`, `*NODE FILE` and `*EL FILE` cards are used to define the output: NT is the temperature, or, equivalently, the total head (Figure 19), and HFL is the heat flux, or, equivalently, the groundwater flow velocity (y-component in Figure 20).

Since the permeability upstream is high, the total head gradient is small. The converse is true downstream. The flow velocity is especially important downstream. There it reaches values up to 2.25×10^{-4} m/s (the red spot in Figure 20), which corresponds to a hydraulic gradient of about 0.56, since the permeability in y-direction downstream is 4×10^{-4} m/s. This is smaller than 1, so no piping will occur. Notice that the velocity is naturally highest immediately next to the dam.

This example shows how seepage problems can be solved by using the heat transfer capabilities in CalculiX GraphiX. The same applies to any other phenomenon governed by a Laplace-type equation.

5.6 Capacitance of a cylindrical capacitor

In this section the capacitance of a cylindrical capacitor is calculated with inner radius 1 m, outer radius 2 m and length 10 m. The capacitor is filled with air, its permittivity is $\epsilon_0 = 8.8542 \times 10^{-12}$ C²/Nm². An extract of the input deck, which is part of the test example suite, is shown below:

```

dam.txt          Sun Feb 12 13:17:58 2006          1
**
** Structure: dam.
** Test objective: groundwater flow analysis.
**
*NODE, NSET=Nall
    1, -3.00000e+01, -1.34110e-07, 0.00000e+00
    2, -3.00000e+01, -4.53062e-01, 0.00000e+00
    3, -2.45219e+01, -4.53062e-01, 0.00000e+00
...
*ELEMENT, TYPE=CPS8, ELSET=Eall
    1, 1, 2, 3, 4, 5, 6, 7, 8
    2, 4, 3, 9, 10, 7, 11, 12, 13
    3, 10, 9, 14, 15, 12, 16, 17, 18
...
*ELSET, ELSET=Earea1
1,
2,
...
*ELSET, ELSET=Earea2
161,
162,
...
*NSET, NSET=Nup
342,
345,
...
*NSET, NSET=Ndown
982,
985,
...
*MATERIAL, NAME=MAT1
*CONDUCTIVITY, TYPE=ORTHO
1.E-2, 25.E-4, 1.E-4
*MATERIAL, NAME=MAT2
*CONDUCTIVITY, TYPE=ORTHO
1.E-4, 4.E-4, 1.E-4
*SOLID SECTION, ELSET=Earea1, MATERIAL=MAT1
*SOLID SECTION, ELSET=Earea2, MATERIAL=MAT2
*INITIAL CONDITIONS, TYPE=TEMPERATURE
Nall, 0.
**
*STEP
*HEAT TRANSFER, STEADY STATE
*BOUNDARY
Nup, 11, 11, 8.5344
*BOUNDARY
Ndown, 11, 11, 3.9624
*NODE PRINT, NSET=Nall
NT
*NODE FILE
NT
*EL FILE
HFL
*END STEP

```

Figure 18: Input deck of the dam problem

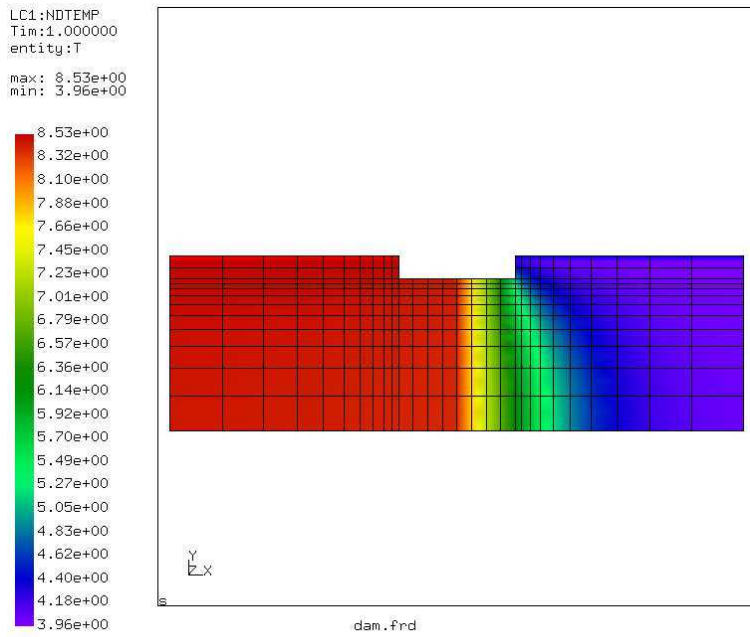

Figure 19: Total head

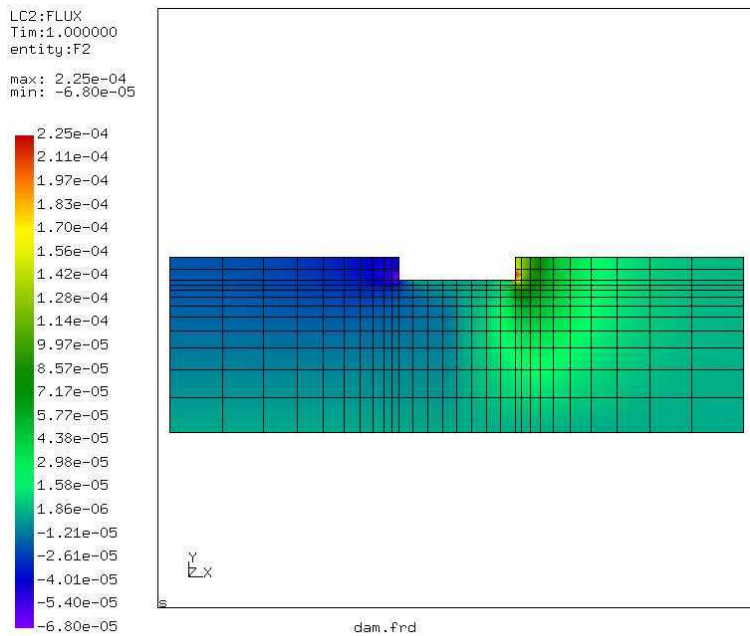

Figure 20: Discharge velocity in y-direction

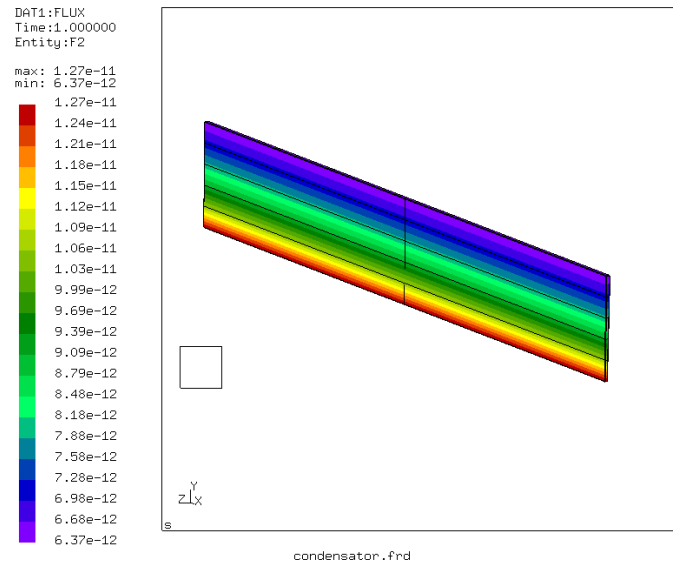

Figure 21: Heat flux in the capacitor's thermal analogy

```

*NODE, NSET=Nall
...
*ELEMENT, TYPE=C3D20, ELSET=Eall
...
*NSET, NSET=Nin
1,
2,
...
*NSET, NSET=Nout
57,
58,
...
*SURFACE, NAME=S1, TYPE=ELEMENT
6, S3
1, S3
*MATERIAL, NAME=EL
*CONDUCTIVITY
8.8541878176e-12
*SOLID SECTION, ELSET=Eall, MATERIAL=EL
*STEP
*HEAT TRANSFER, STEADY STATE
*BOUNDARY
Nin, 11, 11, 2.
  
```

```

Nout,11,11,1.
*EL FILE
HFL
*SECTION PRINT,SURFACE=S1
FLUX
*END STEP

```

As explained in Section 6.9.13 the capacitance can be calculated by determining the total heat flux through one of the capacitor's surfaces due to a unit temperature difference between the surfaces. The material in between the surfaces of the capacitor is assigned a conductivity equal to its permittivity. Here, only one degree of the capacitor has been modeled. In axial direction the mesh is very coarse, since no variation of the temperature is expected. Figure 21 shows that the heat flux at the inner radius is 1.27×10^{-11} W/m². This corresponds to a total heat flow of 7.98×10^{-10} W. The analytical formula for the capacitor yields $2\pi\epsilon_0/\ln(2) = 8.0261 \times 10^{-10}$ C/V.

The total flux through the inner surface S1 is also stored in the .dat file because of the *SECTION PRINT keyword card in the input deck. It amounts to -2.217×10^{-12} W. This value is negative, because the flux is entering the space in between the capacitor's surfaces. Since only one degree was modeled, this value has to be multiplied by 360 and yields the same value as above.

5.7 Hydraulic pipe system

In CalculiX it is possible to perform steady-state hydraulic and aerodynamic network calculations, either as stand-alone applications, or together with mechanical and/or thermal calculations of the adjacent structures. Here, a stand-alone hydraulic network discussed in [10] is analyzed. The input deck pipe.f can be found in the test suite.

The geometry of the network is shown in Figure 22. It is a linear network consisting of:

- an upstream reservoir with surface level at 14.5 m
- an entrance with a contraction of 0.8
- a pipe with a length of 5 m and a diameter of 0.2 m
- a bend of 45 ° and a radius of 0.3 m
- a pipe with a length of 5 m and a diameter of 0.2 m
- a pipe with a length of 5 m and a diameter of 0.3 m
- a pipe with a length of 2.5 m and a diameter of 0.15 m
- a gate valve in E with $\alpha = 0.5$

```

*DENSITY
1000.
*FLUID CONSTANTS
4217. ,1750.E-6,273.
*ELSET,ELSET=E1
2
*ELSET,ELSET=E2
3,5
*ELSET,ELSET=E3
4
*ELSET,ELSET=E4
6
*ELSET,ELSET=E5
7
*ELSET,ELSET=E6
8
*ELSET,ELSET=E7
9,11
*ELSET,ELSET=E8
10
*ELSET,ELSET=E9
12
*ELSET,ELSET=E10
1,13
*FLUID SECTION,ELSET=E1,TYPE=PIPE ENTRANCE,MATERIAL=WATER
0.031416,0.025133
*FLUID SECTION,ELSET=E2,TYPE=PIPE MANNING,MATERIAL=WATER
0.031416,0.05,0.015
*FLUID SECTION,ELSET=E3,TYPE=PIPE BEND,MATERIAL=WATER
0.031416,1.5,45.,0.4
*FLUID SECTION,ELSET=E4,TYPE=PIPE ENLARGEMENT,MATERIAL=WATER
0.031416,0.070686
*FLUID SECTION,ELSET=E5,TYPE=PIPE MANNING,MATERIAL=WATER
0.070686,0.075,0.015
*FLUID SECTION,ELSET=E6,TYPE=PIPE CONTRACTION,MATERIAL=WATER
0.070686,0.017671
*FLUID SECTION,ELSET=E7,TYPE=PIPE MANNING,MATERIAL=WATER
0.017671,0.0375,0.015
*FLUID SECTION,ELSET=E8,TYPE=PIPE GATE VALVE,MATERIAL=WATER
0.017671,0.5
*FLUID SECTION,ELSET=E9,TYPE=PIPE ENLARGEMENT,MATERIAL=WATER
0.017671,1.E6
*FLUID SECTION,ELSET=E10,TYPE=PIPE INOUT,MATERIAL=WATER
*BOUNDARY
3,2,2,1.E5
25,2,2,1.E5

```

```

*STEP
*HEAT TRANSFER,STEADY STATE
*DLOAD
EALL,GRAV,9.81,0.,0.,-1.
*NODE PRINT,NSET=NALL
U
*END STEP

```

In CalculiX linear networks are modeled by means of 3-node network elements (D-type elements). In the corner nodes of the element the temperature and the pressure are unknown. They are assigned to the degrees of freedom 0 and 2, respectively. In the midside node the mass flux is unknown and is assigned to degree of freedom 1. The properties of the network elements are defined by the keyword `*FLUID SECTION`. They are treated extensively in Section 6.4 (gases), 6.5 (liquid pipes) and 6.6 (liquid channels). For the network at stake we need:

- a dummy network entrance element expressing that liquid is entering the network (element 1). It is characterized by a node number 0 as first node
- a network element of type PIPE ENTRANCE at location A (element 2). This element also takes the water depth into account. Notice that there is no special reservoir element. Differences in water level can be taken into account in any element type by assigning the appropriate coordinates to the corner nodes of the element.
- a network element of type PIPE MANNING for the pipe between location A and B (element 3)
- a network element of type PIPE BEND for the bend at location B (element 4)
- a network element of type PIPE MANNING for the pipe between location B and C (element 5)
- a network element of type PIPE ENLARGEMENT for the increase of diameter at location C (element 6)
- a network element of type PIPE MANNING for the pipe between location C and D (element 7)
- a network element of type PIPE CONTRACTION to model the decrease in diameter at location D (element 8)
- a network element of type PIPE MANNING for the pipe between location D and E (element 9)
- a network element of type PIPE GATE VALVE for the valve at location E (element 10)

- a network element of type PIPE MANNING for the pipe between location E and F (element 11)
- a network element of type PIPE ENLARGEMENT for the exit in the reservoir (element 12). Indeed, there is no special reservoir entrance element. A reservoir entrance has to be modeled by a large diameter increase.
- a dummy network exit element expressing that liquid is leaving the network (element 13)

In the input deck, all these elements are defined as D-type elements, their nodes have the correct coordinates and by means of *FLUID SECTION cards each element is properly described. Notice that the dummy network entrance and exit elements are characterized by typeless *FLUID SECTION cards.

For a hydraulic network the material properties reduce to the density (on the *DENSITY card), the specific heat and the dynamic viscosity (both on the *FLUID SECTION card). The specific heat is only needed if heat transfer is being modeled. Here, this is not the case. The dynamic viscosity of water is $1750 \times 10^{-6} \text{N s/m}^2$ [39]. The boundary conditions reduce to the atmospheric pressure in node 3 and 25, both at the liquid surface of the reservoir. Remember that the pressure has the degree of freedom 2 in the corner nodes of the network elements.

Networks are only active in *COUPLED TEMPERATURE-DISPLACEMENT or *HEAT TRANSFER procedures. Here, we do not take the structure into account, so a heat transfer analysis will do. Finally, the gravity loading has to be specified, this is indeed essential for hydraulic networks. Regarding the nodal output, remember that NT requests degree of freedom 0, whereas U requests degrees of freedom 1 to 3. Since we are interested in the mass flux (DOF 1 in the middle nodes) and the pressure (DOF 2 in the corner nodes), U is selected underneath the *NODE PRINT line. Officially, U are displacements, and that's the way they are labeled in the .dat file.

The results in the .dat file look as follows:

```
displacements (vx,vy,vz) for set NALL and time 1.

 2  8.9592E+01  0.0000E+00  0.0000E+00
 3  0.0000E+00  1.0000E+05  0.0000E+00
 4  8.9592E+01  0.0000E+00  0.0000E+00
 5  0.0000E+00  1.3386E+05  0.0000E+00
 6  8.9592E+01  0.0000E+00  0.0000E+00
 7  0.0000E+00  1.2900E+05  0.0000E+00
 8  8.9592E+01  0.0000E+00  0.0000E+00
 9  0.0000E+00  1.2859E+05  0.0000E+00
10  8.9592E+01  0.0000E+00  0.0000E+00
11  0.0000E+00  1.5841E+05  0.0000E+00
12  8.9592E+01  0.0000E+00  0.0000E+00
```

13	0.0000E+00	1.6040E+05	0.0000E+00
14	8.9592E+01	0.0000E+00	0.0000E+00
15	0.0000E+00	1.9453E+05	0.0000E+00
16	8.9592E+01	0.0000E+00	0.0000E+00
17	0.0000E+00	1.7755E+05	0.0000E+00
18	8.9592E+01	0.0000E+00	0.0000E+00
19	0.0000E+00	1.8361E+05	0.0000E+00
20	8.9592E+01	0.0000E+00	0.0000E+00
21	0.0000E+00	1.5794E+05	0.0000E+00
22	8.9592E+01	0.0000E+00	0.0000E+00
23	0.0000E+00	1.6172E+05	0.0000E+00
24	8.9592E+01	0.0000E+00	0.0000E+00
25	0.0000E+00	1.0000E+05	0.0000E+00
26	8.9592E+01	0.0000E+00	0.0000E+00

The mass flux in the pipe (first DOF in the midside nodes, column 1) is constant and takes the value 89.592 kg/s. This agrees well with the result in [10] of 89.4 l/s. Since not all node and element definitions are listed it is useful for the interpretation of the output to know that location A corresponds to node 5, location B to nodes 7-9, location C to nodes 11-13, location D to nodes 15-17, location E to nodes 19-21 and location F to node 23. The second column in the result file is the pressure. It shows that the bend, the valve and the contraction lead to a pressure decrease, whereas the enlargement leads to a pressure increase (the velocity drops).

If the structural side of the network (e.g. pipe walls) is modeled too, the fluid pressure can be mapped automatically onto the structural element faces. This is done by labels of type PxNP in the *DLOAD card.

5.8 Lid-driven cavity

The lid-driven cavity is a well-known benchmark problem for viscous incompressible fluid flow [110]. The geometry at stake is shown in Figure 23. We are dealing with a square cavity consisting of three rigid walls with no-slip conditions and a lid moving with a tangential unit velocity. The lower left corner has a reference static pressure of 0. We are interested in the velocity and pressure distribution for a Reynolds number of 400.

```

**
**   Structure: lid-driven cavity.
**   Test objective: incompressible, viscous, laminar, 3D fluid flow
**
**NODE,NSET=Na11
1,0.00000,0.00000,0.
...
**ELEMENT,TYPE=F3D6,ELSET=Ea11

```

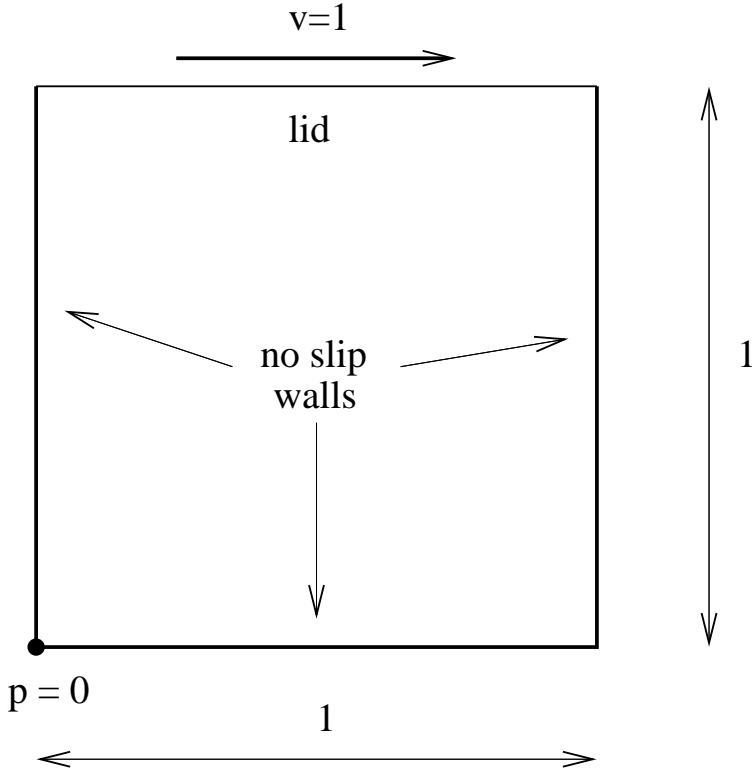

Figure 23: Geometry of the lid-driven cavity

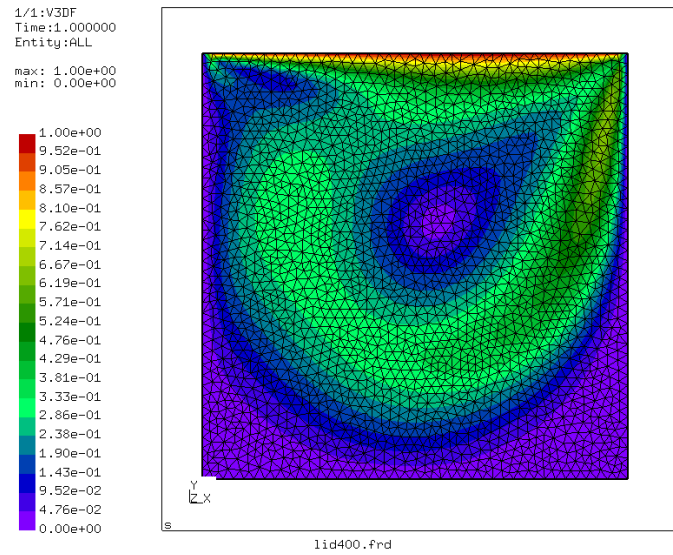

Figure 24: Mesh of the lid-driven cavity

```

1,1543,1626,1624,3918,4001,3999
...
*NSET,NSET=Nin
1774,
...
*NSET,NSET=Nwall
1,
...
*NSET,NSET=N1
1374,
...
*BOUNDARY
Nall,3,3,0.
Nwall,1,2,0.
Nin,2,2,0.
1,8,8,0.
2376,8,8,0.
*MATERIAL,NAME=WATER
*DENSITY
1.
*FLUID CONSTANTS
1.,.25E-2,293.
*SOLID SECTION,ELSET=Eall,MATERIAL=WATER

```

```

*INITIAL CONDITIONS,TYPE=FLUID VELOCITY
Nall,1,0.
Nall,2,0.
Nall,3,0.
*INITIAL CONDITIONS,TYPE=PRESSURE
Nall,0.
**
*STEP,INCF=20000
*CFD,STEADY STATE
*BOUNDARY
Nin,1,1,1.
*NODE FILE,FREQUENCYF=200
VF,PSF
*END STEP

```

The input deck is listed above (this deck is also available in the fluid test suite as file lid400.inp). Although the problem is essentially 2-dimensional it was modeled as a 3-dimensional problem with unit thickness since 2-dimensional fluid capabilities are not available in CalculiX. The mesh (2D projection) is shown in Figure 24. It consists of 6-node wedge elements. There is one element layer across the thickness. This is sufficient, since the results do not vary in thickness direction. The input deck starts with the coordinates of the nodes and the topology of the elements. The element type for fluid volumetric elements is the same as for structural elements with the C replaced by F (fluid): F3D6. The nodes making up the lid and those belonging to the no-slip walls are collected into the nodal sets Nin and Nwall, respectively. The nodal set N1 is created for printing purposes. It contains a subset of nodes close to the lid.

The homogeneous boundary conditions (i.e. those with zero value) are listed next underneath the *BOUNDARY keyword: The velocity in all nodes in z-direction is zero, the velocity at the walls is zero (no-slip condition) as well as the normal velocity at the lid. Furthermore, the reference point in the lower left corner of the cavity has a zero pressure (node 1 and its corresponding node across the thickness 2376). The material definition consists of the density, the heat capacity and the dynamic viscosity. The density is set to 1. The heat capacity and dynamic viscosity are entered underneath the *FLUID CONSTANTS keyword. The heat capacity is not needed since the calculation is steady state, so its value here is irrelevant. The value of the dynamic viscosity was chosen such that the Reynolds number is 400. The Reynolds number is defined as velocity times length divided by the kinematic viscosity. The velocity of the lid is 1, its length is 1 and since the density is 1 the kinematic and dynamic viscosity coincide. Consequently, the kinematic viscosity takes the value 1/400. The material is assigned to the elements by means of the *SOLID SECTION card.

The unknowns of the problem are the velocity and static pressure. No thermal boundary conditions are provided, so the temperature is irrelevant. All

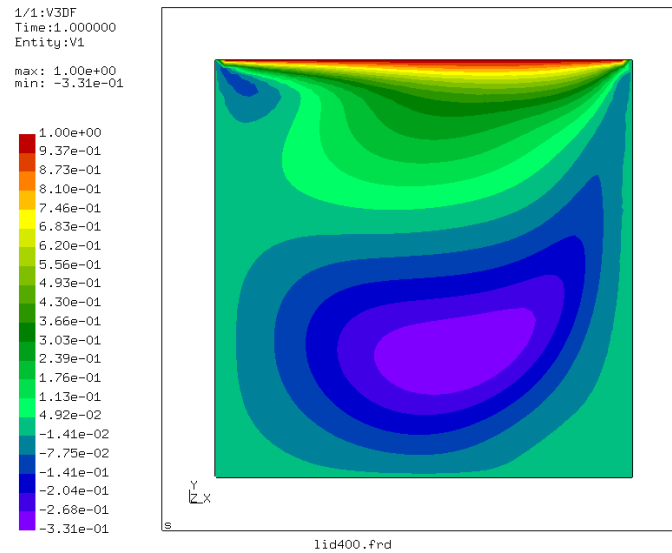

Figure 25: x-component of the velocity in the lid-driven cavity

initial values for the unknowns are set to 0 by means of the *INITIAL CONDITIONS,TYPE=FLUID VELOCITY and *INITIAL CONDITIONS,TYPE=PRESSURE cards. Notice that for the velocity the initial conditions have to be specified for each degree of freedom separately.

The step is as usual started with the *STEP keyword. The maximum number of increments, however, is for fluid calculations governed by the parameter INCF. For steady state fluid calculations the keyword *CFD,STEADY STATE is to be used. The values underneath this line are not relevant for fluid calculations, since the increment size is automatically chosen such that the procedure is stable. The nonzero tangential velocity of the lid is entered underneath the *BOUNDARY card. Recall that non-homogeneous (i.e. nonzero) boundary conditions have to be defined within a step. The step ends with a nodal print request for the velocity VF and the static pressure PS. The printing frequency is defined to be 200 by means of the FREQUENCYF parameter. This means, that results will be stored every 200 increments.

The velocity distribution in x-direction (i.e. the direction tangential to the lid) is shown in Figure 25. The smallest value (-0.33) and its location agree very well with the results in [110]. Figure 26 shows a vector plot of the velocity. Near the lid there is a large gradient, in the lower left and lower right corner are dead zones. The pressure plot (Figure 27) reveals a low pressure zone in the center of the major vortex and in the left upper corner. The right upper corner is a stagnation point for the x-component of the velocity and is characterized by a significant pressure built-up.

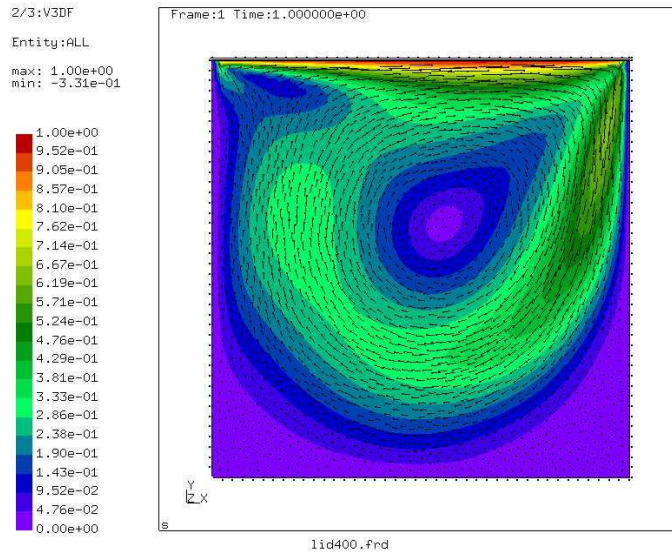

Figure 26: Velocity distribution in the lid-driven cavity

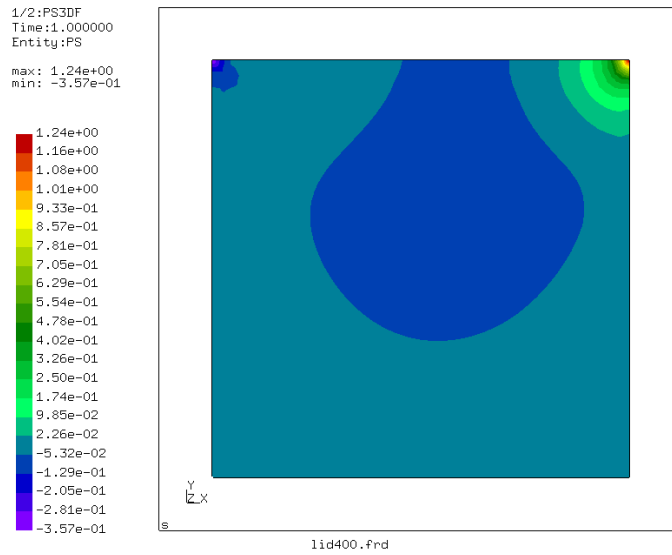

Figure 27: Pressure distribution in the lid-driven cavity

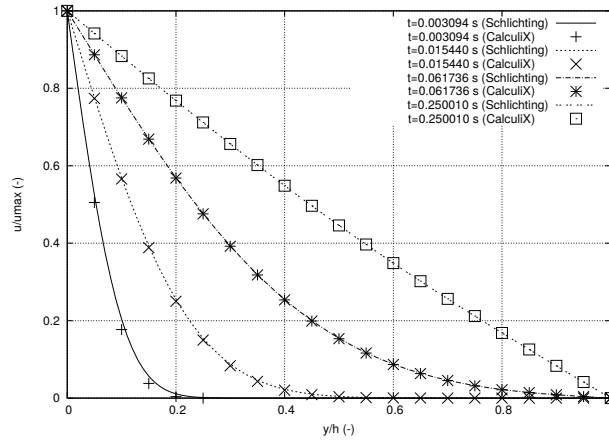

Figure 28: Velocity across the space in between the plates for different times

5.9 Transient laminar incompressible Couette problem

Another well-known problem is the incompressible laminar flow between two parallel plates. At time zero both plates are at rest, whereas at positive times one of the plates is moved parallel to the other plate with a velocity of 1. The analytical solution can be found in [83] in the form of a series expansion containing the complementary error function erfc . In the steady state regime the velocity profile is linear across the space in between the plates. The velocity profiles at different times are shown in Figure 28 and compared with the analytical solution for a unity distance between the plates and a kinematic viscosity $\nu = 1$. The input deck for the CalculiX results can be found in the test suite (couette1.inp). The figure shows a good agreement between the numerical and analytical values, indicating that the time integration in the CFD-implementation in CalculiX is correct. The small deviations at small times are due to the rather course mesh.

5.10 Stationary laminar inviscid compressible airfoil flow

In [77] the results of CFD-calculations for several airfoils are reported. Here, the computations for $M_\infty = 1.2$ (Mach number at infinity) and $\alpha = 7^\circ$ (angle of attack) are reported. The input deck for this calculation can be found in the fluid examples test suite for the Finite Element Method (agard05.inp).

To explain the differences in the input deck between incompressible and compressible flow the crucial section from the compressible input deck is reproduced below.

```
*EQUATION
2
3,2,-0.99030509E+00,3,1,-0.13890940E+00
2
```

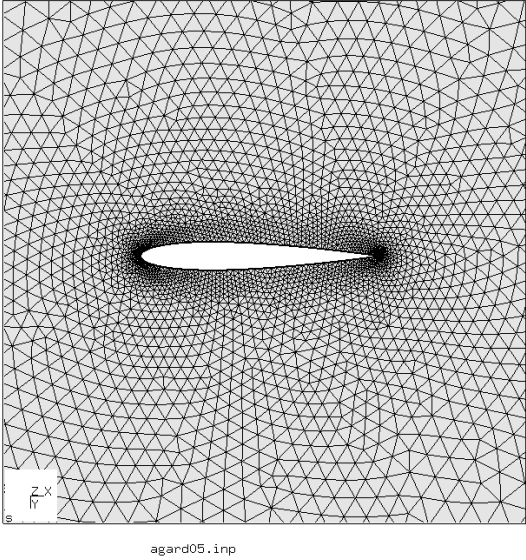



Figure 29: Mesh for the naca012 airfoil flow

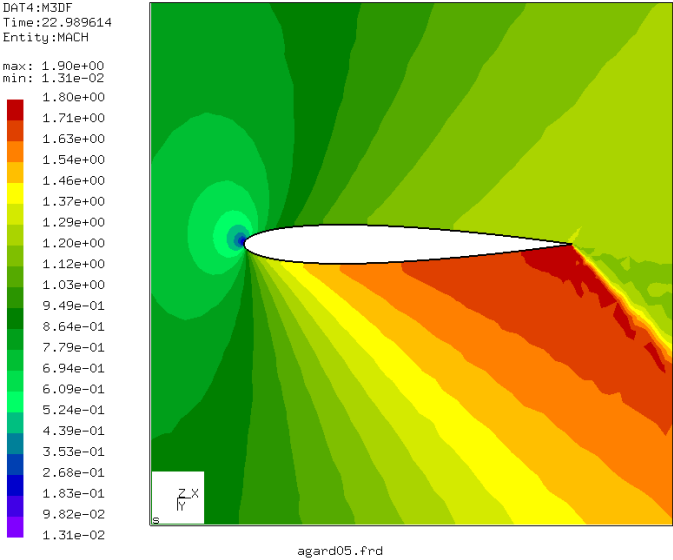

Figure 30: Mach number in the naca012 airfoil flow

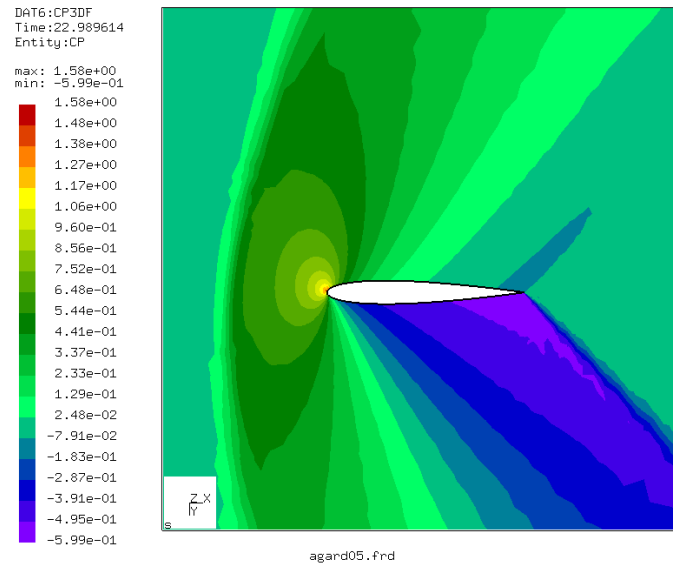

Figure 31: Pressure coefficient in the naca012 airfoil flow

```

3756,2,-0.99030509E+00,3756,1,-0.13890940E+00
...
*MATERIAL,NAME=AIR
*CONDUCTIVITY
0.
*FLUID CONSTANTS
1.,0.,293.
*SPECIFIC GAS CONSTANT
0.285714286d0
*SOLID SECTION,ELSET=Ea11,MATERIAL=AIR
*PHYSICAL CONSTANTS,ABSOLUTE ZERO=0.
*INITIAL CONDITIONS,TYPE=FLUID VELOCITY
Na11,1,0.99254615
Na11,2,0.12186934
Na11,3,0.d0
*INITIAL CONDITIONS,TYPE=PRESSURE
Na11,0.49603175
*INITIAL CONDITIONS,TYPE=TEMPERATURE
Na11,1.73611111
*VALUES AT INFINITY
1.73611111,1.,0.49603175,1.,1.
**
*STEP,INCF=200000,SHOCK SMOOTHING=0.01

```

```

*CFD,STEADY STATE,COMPRESSIBLE
1.,1.
*BOUNDARY
BOU1,11,11,1.73611111
BOU1,1,1,0.99254615
BOU1,2,2,0.12186934
BOU1,8,8,0.49603175
Nall,3,3,0.
*NODE FILE,FREQUENCYF=40000
VF,PSF,CP,TSF,TTF,MACH
*END STEP

```

Since for compressible flow the temperature, velocity and pressure are linked through the ideal gas equation, the energy conservation equation is always used and the definition of the thermal conductivity and specific heat is mandatory. Inviscid flow is triggered by the definition of a zero viscosity and a zero thermal conductivity (therefore, the viscous terms in the conservation of momentum and conservation of energy equation disappear). Slip boundary conditions at the airfoil surface are realized through equations. The specific gas constant is defined with the appropriate keyword. It only depends on the kind of gas and not on the temperature. The physical constants card is used to define absolute zero for the temperature scale. This information is needed since the temperature in the gas equation must be specified in Kelvin. Initial conditions must be specified for the velocity, pressure and temperature. Careful selection of these values can shorten the computational time. The values at infinity (defined with the *VALUES AT INFINITY card) are used to calculate the pressure coefficient $C_p = (p - p_{inf}) / (\frac{1}{2} \rho_{inf} V_{inf}^2)$. In viscous calculations they can be used for the computation of the friction coefficient too. The smoothing parameter on the *STEP card is used to define shock smoothing and will be discussed further down.

The COMPRESSIBLE parameter on the *CFD card indicates that this is a compressible CFD calculation. The consequence of this is that the ideal gas equation is used to link the density, pressure and temperature. Therefore, no *DENSITY card should be present in the input deck, and the *SPECIFIC GAS CONSTANT card is required. The use of the STEADY STATE parameter tells CalculiX that the calculation is stationary. Instationary calculations are triggered by dropping this parameter. In reality, all CFD-calculations in CalculiX are instationary. The STEADY STATE parameter, however, forces the calculations to be pursued until steady state is reached (so the time used is virtual) or until the maximum number of subincrements (parameter INCF on the *STEP card) is reached. Transient calculations stop as soon as the final time is reached (the time is real).

In compressible calculations shock smoothing is frequently needed in order to avoid divergence. Shock smoothing, however, can change the solution. Therefore, the shock smoothing coefficient, which can take values between 0. and 2., should be chosen as small as possible. For the agard05 example a value of 0.01

was needed. In general, additional viscosity will reduce the shock smoothing needed to avoid divergence. There is a second effect of the shock smoothing coefficient: there is no clear steady state convergence any more. In order to understand this some additional information about the way CFD-calculations in CalculiX are performed is needed. The initial increment size which is specified by the user underneath the *CFD card is a mechanical increment size. For each mechanical increment an instationary CFD-calculation is performed subject to the actual loads (up to steady state for a STEADY STATE calculation). For this CFD-calculation subincrements are used, the size of which depends on the physical characteristics of the flow (viscosity, heat conductivity etc.). They are determined such that stability is assured (or at least very likely). In CalculiX, steady state convergence is detected as soon as the change in the conservative variables ($\rho, \rho u, \rho v$ etc.) from subincrement to subincrement does not exceed 10^{-8} times the actual values of these variables. In calculations with a nonzero shock smoothing coefficient the change in variables at first decreases down to a certain level about which it oscillates erratically. Therefore, it is likely that convergence will never be detected. The change in the conservative variables is stored in a file with the name `jobname.fcv` (assuming the input deck to be `jobname.inp`). The user may force convergence by limiting the number of subincrements with the INCF parameter on the *STEP card. As soon as INCF subincrements are calculated the CFD-calculation is assumed to be finished and the next mechanical increment is started.

The smoothing coefficient may be further reduced by choosing smaller CFD subincrements. The fifth entry underneath the *CFD-card is the factor by which the CFD increment size calculated based on physical parameters such as viscosity and local velocity is divided. Default is 1.25 for compressible calculations and 1. for incompressible calculations. The factor cannot be less than the default. For instance, a factor of 5. implies that the time increment is chosen as 20 % of the physically based time increment. Larger factors will decrease the need for shock smoothing but also linearly increase the computational time.

If the calculation diverges, the shock smoothing coefficient is set to 0.001 if it was zero before, and to twice its value else, and the calculation is repeated. If the value exceeds 2 the calculation is stops with an error message. Shock smoothing is only used for compressible calculations.

Figure 29 shows the mesh used for the agard05 calculation. It consists of linear wedge elements. In CalculiX, only linear elements (tetrahedra, hexahedra or wedges) are allowed for CFD-calculations. It is finer along the airfoil (but not as fine as needed to capture the boundary layer in viscous calculations). Figures 30 and 31 show the Mach number and the pressure coefficient, respectively. The maximum Mach number in [77] is about 1.78, the maximum pressure coefficient is about -0.55. This agrees well with the present results. Increasing the shock smoothing coefficient leads to smoothing fringe plots, however, the actual values become worse.

The total temperature for this calculation (not shown here) was nearly constant. Recall that the total change of the total temperature along a stream line is given by:

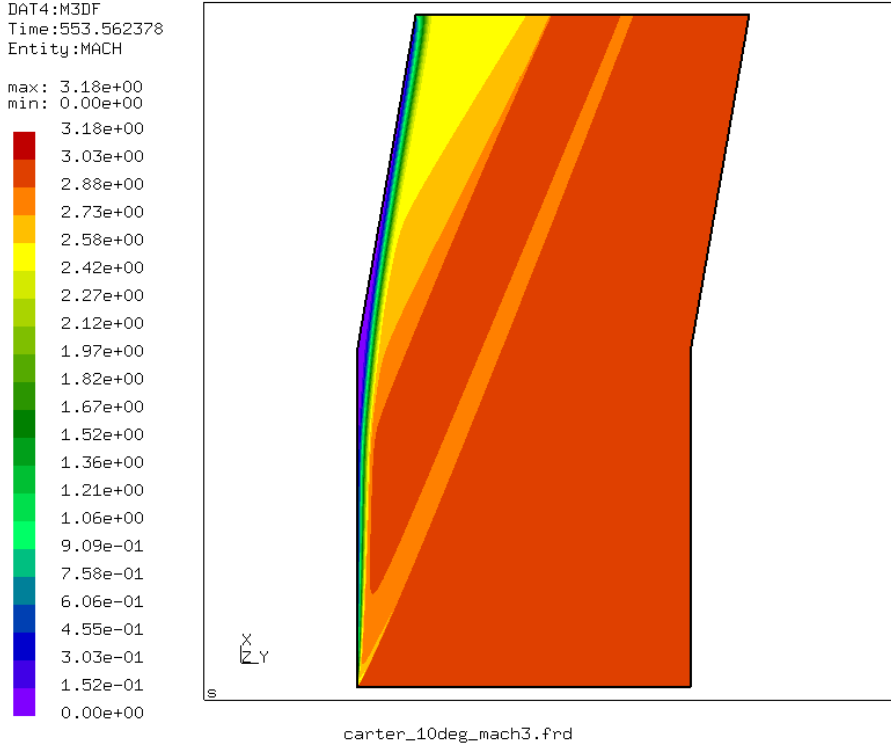

Figure 32: Mach number for the Carter problem

$$\frac{D\rho c_p T_t}{Dt} = (t^{lm} v_m)_{,l} - \nabla \cdot \mathbf{q} + \rho h_\theta + \frac{\partial p}{\partial t} + \rho f^m v^k \delta_{mk}. \quad (1)$$

The terms on the right hand side correspond to the viscous work (zero), the heat flow (zero, since the heat conduction coefficient is zero), the heat introduced per unit mass (zero), the change in pressure (zero in the steady state regime) and the work by external body forces (zero).

5.11 Laminar viscous compressible compression corner flow

This benchmark example is described in [15]. The input deck for the CalculiX computation is called `carter_10deg_mach3.inp` and can be found in the fluid test example suite. The flow is entering at Mach 3 parallel to a plate of length 16.8 after which a corner of 10° arises. The Reynolds number based on a unit length is 1000., which yields for a unit velocity a dynamic viscosity coefficient $\mu = 10^{-3}$. No units are specified: the user can choose appropriate consistent units. Choosing $c_p = 1$ and $\kappa = 1.4$ leads to a specific gas constant $r = 0.286$.

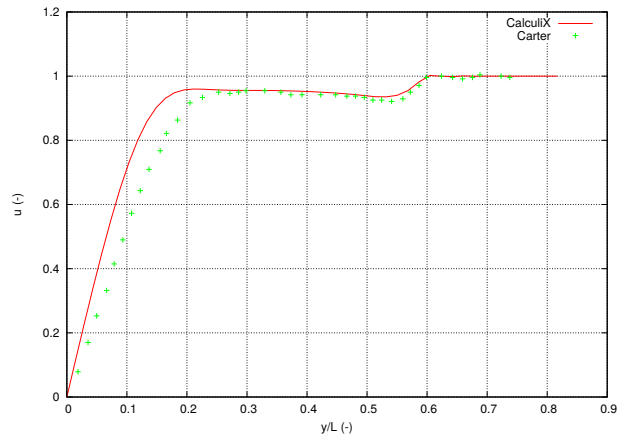

Figure 33: velocity profile across the flow for the Carter problem

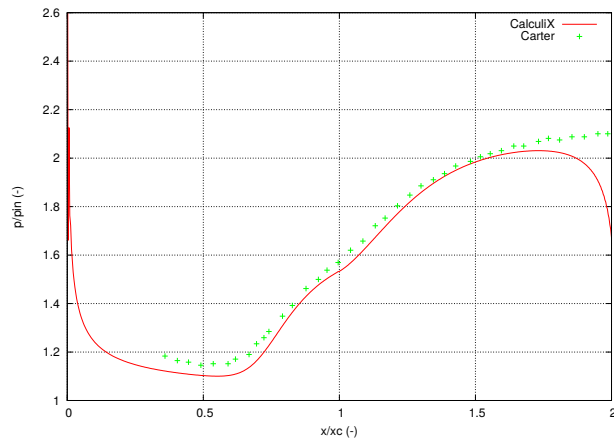

Figure 34: Static pressure at the wall for the Carter problem

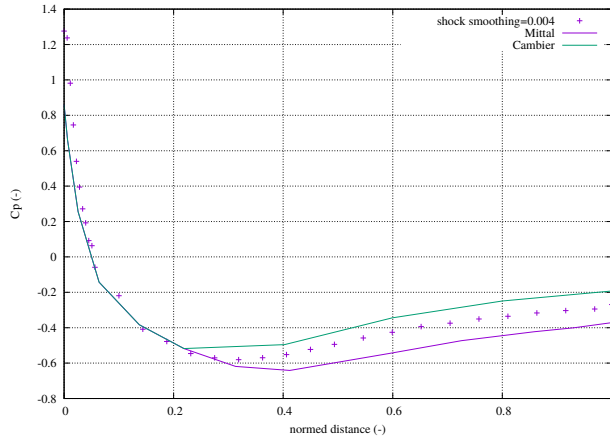

Figure 35: Pressure coefficient for laminar viscous flow about a naca012 airfoil

The selected Mach number leads to an inlet temperature of $T = 0.278$. The ideal gas law yields a static inlet pressure of $p = 0.0794$ (assuming an unit inlet density). The wall is assumed to be isothermal at a total temperature of $T_t = 0.778$. Finally, the assumed Prandtl number ($Pr = \mu c_p / \lambda$) of 0.72 leads to a conduction coefficient of 0.00139.

A very fine mesh with about 425,000 nodes was generated, gradually finer towards the wall ($y^+ = 0.885$ for the closest node near the wall at $L=1$ from the inlet, where $y^+ = u_\tau y / \nu$ and $u_\tau = \sqrt{\tau / \rho}$; y is the distance from the wall and τ is the shear stress parallel to the wall). The Mach number is shown in Figure 32. The shock wave emanating from the front of the plate and the separation and reattachment compression fan at the kink in the plate are clearly visible. One also observes the thickening of the boundary layer near the kink leading to a recirculation zone. Figure 33 shows the velocity component parallel to the inlet plate orientation across a line perpendicular to a plate at unit length from the entrance. One notices that the boundary layer in the CalculiX calculation is smaller than in the Carter solution. This is caused by the temperature-independent viscosity. Applying the Sutherland viscosity law leads to the same boundary layer thickness as in the reference. In CalculiX, no additional shock smoothing was necessary. Figure 34 plots the static pressure at the wall relative to the inlet pressure versus a normalized plate length. The reference length for the normalization was the length of the plate between inlet and kink (16.8 unit lengths). So the normalized length of 1 corresponds to the kink. There is a good agreement between the CalculiX and the Carter results, apart from the outlet zone, where the outlet boundary conditions influence the CalculiX results.

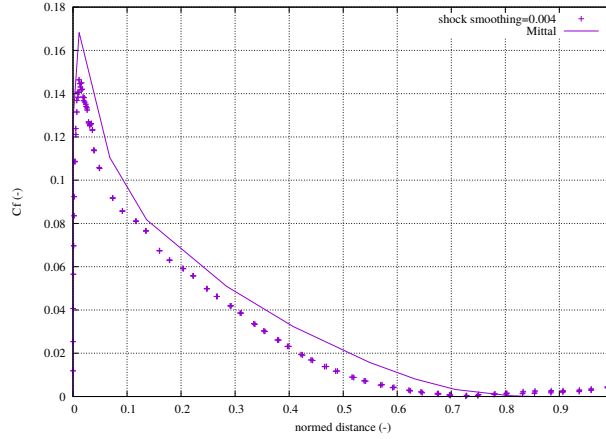

Figure 36: Friction coefficient for laminar viscous flow about a naca012 airfoil

5.12 Laminar viscous compressible airfoil flow

A further example is the laminar viscous compressible flow about a naca012 airfoil. Results for this problem were reported by [63]. The entrance Mach number is 0.85, the Reynolds number is 2000. Of interest is the steady state solution. In CalculiX this is obtained by performing a transient CFD-calculation up to steady state. The input deck for this example is called `naca012_visc_mach0.85.inp` and can be found among the CFD test examples. Basing the Reynolds number on the unity chord length of the airfoil, a unit entrance velocity and a unit entrance density leads to a dynamic viscosity of $\mu = 5 \times 10^{-4}$. Taking $c_p = 1$ and $\kappa = 1.4$ leads to a specific gas constant $r = 0.2857$ (all in consistent units). Use of the entrance Mach number determines the entrance static temperature to be $T_s = 3.46$. Finally, the ideal gas law leads to a entrance static pressure of $p_s = 0.989$. Taking the Prandtl number to be 1 determines the heat conductivity $\lambda = 5^{-4}$. The surface of the airfoil is assumed to be adiabatic.

The results for the pressure and the friction coefficient at the surface of the airfoil are shown in Figures 35 and 36, respectively, as a function of the shock smoothing coefficient. The pressure coefficient is defined by $c_p = (p - p_\infty)/(0.5\rho_\infty v_\infty^2)$, where p is the local static pressure, p_∞ , ρ_∞ and v_∞ are the static pressure, density and velocity at the entrance, respectively. Figure 35 shows that the result for a shock smoothing coefficient of 0.004, which is the smallest value not leading to divergence is in between the results reported by Cambier and Mittal. The friction coefficient is defined by $\tau_w/(0.5\rho_\infty v_\infty^2)$, where τ_w is the local shear stress. The CalculiX results with a shock smoothing coefficient of 0.004 are smaller than the ones reported by Mittal. The c_f -peak at the front of the airfoil is also somewhat too small: the literature result is 0.17, the CalculiX peak reaches only up to 0.15. The shock coefficient is already very small and it is the smallest feasible value for this mesh anyway, so decreasing

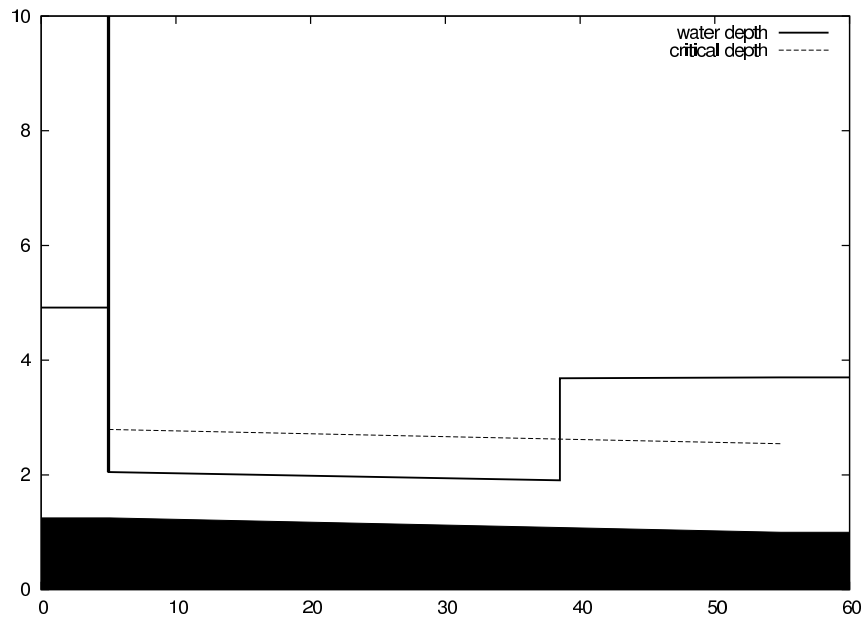

Figure 37: Water depth in a channel with hydraulic jump

the shock coefficient, which would further increase the peak, is not an option. A too coarse mesh density at that location may also play a role.

5.13 Channel with hydraulic jump

That open channel flow can be modeled as a one-dimensional network is maybe not so well known. The governing equation is the Bresse equation (cf. Section 6.9.18) and the available fluid section types are listed in Section 6.6.

The input deck for the present example is shown below.

```

**
**  Structure: channel connecting two reservoirs.
**  Test objective: steep slope, frontwater - jump -
**                  backwater curve
**
*NODE,NSET=NALL
1,0.,0.,0.
2,1.,0.,0.
4,3.,0.,0.
6,5.,0.,0.
7,6.,0.,0.
8,7.,0.,0.
9,8.,0.,0.

```

```

10,9.,0.,0.
11,10.,0.,0.
*ELEMENT,TYPE=D,ELSET=EALL
1,0,1,2
2,2,4,6
4,6,7,8
5,8,9,10
6,10,11,0
*MATERIAL,NAME=WATER
*DENSITY
1000.
*FLUID CONSTANTS
4217.,1750.E-6,273.
*ELSET,ELSET=E1
1,6
*ELSET,ELSET=E2
2
*ELSET,ELSET=E4
4
*ELSET,ELSET=E5
5
*FLUID SECTION,ELSET=E1,TYPE=CHANNEL INOUT,MATERIAL=WATER
*FLUID SECTION,ELSET=E2,TYPE=CHANNEL SLUICE GATE,MANNING,MATERIAL=WATER
10.,0.,0.1,0.005,0.01,0.8
*FLUID SECTION,ELSET=E4,TYPE=CHANNEL STRAIGHT,MANNING,MATERIAL=WATER
10.,0.,49.8,0.005,0.01
*FLUID SECTION,ELSET=E5,TYPE=CHANNEL RESERVOIR,MANNING,MATERIAL=WATER
10.,0.,0.1,0.005,0.01
*BOUNDARY
10,2,2,2.7
*BOUNDARY,MASS FLOW
1,1,1,60000.
*STEP
*HEAT TRANSFER,STEADY STATE
*DLOAD
EALL,GRAV,9.81,0.,0.,-1.
*NODE PRINT,NSET=NALL
U
*END STEP

```

It is one of the examples in the CalculiX test suite (channel3). The channel is made up of five 3-node network elements (type D) in one long line. The nodes have fictitious coordinates. They do not enter the calculations, however, they are listed in the .frd file. For a proper visualization with CalculiX GraphiX it may be advantageous to use the correct coordinates. As usual in networks, the final node of the entry and exit element have the label zero. The material is

water and is characterized by its density, heat capacity and dynamic viscosity. Next, the elements are stored in appropriate sets (by using *ELSET) for the sake of referencing in the *FLUID SECTION card.

The structure of the channel becomes apparent when analyzing the *FLUID SECTION cards: upstream there is a sluice gate, downstream there is a large reservoir and both are connected by a straight channel. The sluice gate is described by its width (10 m), a trapezoid angle $\theta = 0$ (i.e. the cross section is rectangular) and a slope S_0 of 0.005. Since the parameter MANNING has been used on the *FLUID SECTION card, the next parameter ($0.01 \text{ m}^{-1/3} \text{ s}$) is the Manning coefficient. Finally, the gate height is 0.8 m. The slope and the Manning coefficient are needed to calculate the critical and the normal depth and should be the same as in the downstream straight channel element. The constants for the straight channel element can be checked in Section 6.6. Important here is the length of 49.8 m. The last element, the reservoir, is again a very short element (length 0.1 m).

Next, the boundary conditions are defined: the reservoir fluid depth is 2.7 m, whereas the mass flow is 60000 kg/s . Network calculations in CalculiX are a special case of steady state heat transfer calculations, therefore the *HEAT TRANSFER, STEADY STATE card is used. The prevailing force is gravity.

When running CalculiX a message appears that there is a hydraulic jump at relative location 0.67 in element 4 (the straight channel element). This is also clear in Figure 37, where the channel has been drawn to scale. The sluice gate is located at $x=5$ m, the reservoir starts at $x=55$ m. The bottom of the channel is shaded black. The water level behind the gate was not prescribed and is one of the results of the calculation: 3.667 m. The water level at the gate is controlled by its height of 0.8 m. A frontwater curve (i.e. a curve controlled by the upstream conditions - the gate) develops downstream and connects to a backwater curve (i.e. a curve controlled by the downstream conditions - the reservoir) by a hydraulic jump at a x -value of 38.5 m. In other words, the jump connects the upstream supercritical flow to the downstream subcritical flow. The critical depth is illustrated in the figure by a dashed line. It is the depth for which the Froude number is 1: critical flow.

In channel flow, the degrees of freedom for the mechanical displacements are reserved for the mass flow, the water depth (the component in direction of the gravity vector, not the depth orthogonal to the channel floor, since the latter quantity is discontinuous at the location of a slope change) and the critical depth, respectively. Therefore, the option U underneath the *NODE PRINT card will lead to exactly this information in the .dat file. The same information can be stored in the .frd file by selecting MF, DEPT and HCRI underneath the *NODE FILE card.

5.14 Cantilever beam using beam elements

Previously, a thick cantilever beam was modeled with volume elements. In the present section quadratic beam elements are used for a similar exercise (Section 6.2.33). Beam elements are easy to define: they consist of three nodes on a line.

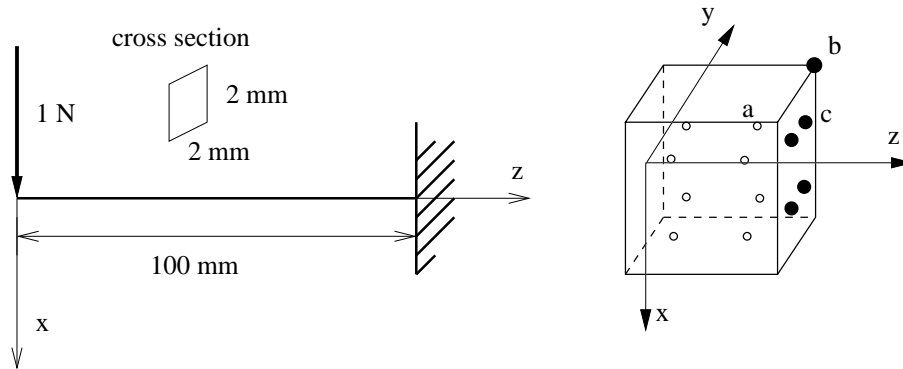

Figure 38: Geometry of the beam

Internally, they are expanded into volumetric elements. There are two types of beam elements: B32 elements, which are expanded into C3D20 elements, and B32R (reduced integration) elements, which are expanded into C3D20R elements. Based on the results in the present section, the B32R element is highly recommended. The B32 element, on the other hand, should be avoided especially if section forces are needed.

The first cantilever beam which is looked at is 100 mm long and has a square cross section of $2 \times 2 \text{ mm}^2$. The axis of the beam is along the global z -direction. This beam is modeled with just one element and loaded at its end by a unit force in x -direction, Figure 38. We are interested in the stresses at integration point a and at node b , the section forces at the beam's fixed end, and the displacement in x at the free end. The location of the integration point a is at $x = -1/\sqrt{3}$, $y = 1/\sqrt{3}$ and $z = 50(1 + 1/\sqrt{3})$, the nodal coordinates of b are $x = -1$, $y = 1$ and $z = 100$ [23]. The material is isotropic linear elastic with a Young's modulus of 100,000 MPa and a Poisson's ratio of 0.3.

The input deck for this example is very similar to the `simplebeam.inp` example in the test suite:

```

**
**  Structure: cantilever beam, one element
**  Test objective: B32R elements.
**
*NODE,NSET=Na11
1, 0, 0, 0
2, 0, 0, 50
3, 0, 0, 100
*ELEMENT,TYPE=B32R,ELSET=EA11
1,1,2,3
*BOUNDARY
3,1,6

```

```

*MATERIAL,NAME=ALUM
*ELASTIC
1E7,.3
*BEAM SECTION,ELSET=EA11,MATERIAL=ALUM,SECTION=RECT
2.,2.
1.d0,0.d0,0.d0
*STEP
*STATIC
*CLOAD
1,1,1.
*EL PRINT,ELSET=EA11
S
*NODE FILE
U
*EL FILE,SECTION FORCES
S,NOE
*END STEP

```

The stresses at the integration points are obtained by a *EL PRINT card, the stresses at the nodes by the OUTPUT=3D option (default) on the *EL FILE card, whereas for the section forces the SECTION FORCES option on the same card is used (this option is mutually exclusive with the OUTPUT=3D option). The displacements are best obtained in the non-expanded view, i.e. using the OUTPUT=2D option. This means that for the present results the example had to be run twice: once with the OUTPUT=3D option and once with the SECTION FORCES option.

The results are summarized in Table 3. The {mm, N, s, K} system is used. The reference results are analytical results using simple beam theory [76]. The agreement is overwhelming. The stresses at the integration points match exactly, so do the extrapolated normal stresses to the nodes. The shear stresses need special attention. For a beam the shear stress varies parabolically across the section. A quadratic volumetric element can simulate only a linear stress variation across the section. Therefore, the parabolic variation is approximated by a constant shear stress across the section. Since the reduced integration points (at $\pm 1/\sqrt{3}$) happen to be points at which the parabolic stress variation attains its mean value the values at the integration points are exact! The extrapolated values to the nodes take the same constant value and are naturally wrong since the exact value at the corners is zero.

The section forces are obtained by

1. calculating the stresses at the integration points (inside the element, such as integration point a)
2. extrapolating those stresses to the corner nodes (such as node b)
3. calculating the stresses at the middle nodes by interpolation between the adjacent corner nodes

Table 3: Results for the square section beam subject to bending (1 element).

result	value	reference
$\sigma_{zz}(a)$	34.151	34.151
$\sigma_{xz}(a)$	-0.25	-0.25
F_{xx}	-1.	-1.
M_{yy}	100.	100.
$\sigma_{zz}(b)$	75.	75.
$\sigma_{xz}(b)$	-0.25	0.
u_x	2.25	2.50

Table 4: Results for the square section beam subject to bending (5 elements).

result	value	reference
$\sigma_{zz}(a)$	41.471	41.471
$\sigma_{xz}(a)$	-0.25	-0.25
F_{xx}	-1.	-1.
M_{yy}	100.	100.
$\sigma_{zz}(b)$	75.	75.
$\sigma_{xz}(b)$	-0.25	0.
u_x	2.44	2.50

4. interpolating the stresses at all nodes within a section face onto the reduced integration points within the face (such as integration point c, using the shape functions of the face)
5. integrating these stresses numerically.

As shown by Table 3 this procedure yields the correct section forces for the square beam.

The displacements at the beam tip are off by 10 %. The deformation of a beam subject to a shear force at its end is third order, however, the C3D20R element can only simulate a quadratic behavior. The deviation is reduced to 2.4 % by using 5 elements (Table 4). Notice that integration point a is now closer to the fixation (same position is before but in the element adjacent to the fixation).

The same beam was now subjected to a torque of 1 Nmm at its free end. The results are summarized in Table 5.

The torque is matched perfectly, the torsion at the end of the beam (u_y is the displacement in y-direction at the corresponding node of node b) is off by 15 % [76]. The shear stresses at node b are definitely not correct (there is no shear stress at a corner node), however, the integration of the values interpolated from the nodes at the facial integration points yields the exact torque! Using more

Table 5: Results for the square section beam subject to torsion (1 element).

result	value	reference
$\sigma_{xz}(a)$	-0.21651	-
$\sigma_{yz}(a)$	-0.21651	-
M_{zz}	1.	1.
$\sigma_{xz}(b)$	-0.375	0
$\sigma_{yz}(b)$	-0.375	0
u_y	$9.75 \cdot 10^{-4}$	$1.1525 \cdot 10^{-3}$

Table 6: Results for the circular section beam subject to bending (1 element).

result	value	reference
$\sigma_{zz}(a)$	34.00	52.26
$\sigma_{xz}(a)$	-0.322	-0.318
F_{xx}	-0.99996	-1.
M_{yy}	58.7	100.
$\sigma_{zz}(b)$	62.8	90.03
$\sigma_{xz}(b)$	-0.322	-0.318
u_x	2.91	4.24

elements does not change the values in Table 5.

The same exercise is now repeated for a circular cross section (radius = 1 mm, same length, boundary conditions and material data as for the rectangular cross section). For such a cross section the vertex nodes of the element lie at $x, y = \pm 0.7071, \pm 0.7071$, whereas the middle nodes lie at $x, y = 0, \pm 1$ and $x, y = \pm 1, 0$. The integration points are located at $x, y = \pm 0.5210$. The results for bending with just one element are shown in Table 6 and with 5 elements in Table 7.

For just one element the shear stress is quite close to the analytical value, leading to a even better match of the shear force. This is remarkable and can only be explained by the fact that the cross area of the piecewise quadratic approximation of the circular circumference is smaller and exactly compensates the slightly higher shear stress. A similar effect will be noticed for the torque. The normal stress, however, is far off at the integration points as well as at the nodes leading to a bending moment which is way too small. The same applies to the deformation in x-direction. Using five elements leads to a significant improvement: the bending moment is only 2 % off, the deformation at the free end 9 %. Here again one can argue that the deformation is of cubic order, whereas a quadratic element can only simulate a quadratic change. Using more elements consequently improves the results.

The results for a torque applied to a circular cross section beam is shown in

Table 7: Results for the circular section beam subject to bending (5 elements).

result	value	reference
$\sigma_{zz}(a)$	59.77	63.41
$\sigma_{xz}(a)$	-0.322	-0.318
F_{xx}	-0.99996	-1.
M_{yy}	102.	100.
$\sigma_{zz}(b)$	109.	90.03
$\sigma_{xz}(b)$	-0.322	-0.318
u_x	3.86	4.24

Table 8: Results for the circular section beam subject to torsion (1 element).

result	value	reference
$\sigma_{xz}(a)$	-0.309	-0.331
$\sigma_{yz}(a)$	-0.309	-0.331
M_{zz}	0.999994	1.
$\sigma_{xz}(b)$	-0.535	-0.450
$\sigma_{yz}(b)$	-0.535	-0.450
u_y	$1.54 \cdot 10^{-3}$	$1.66 \cdot 10^{-3}$

Table 8 (1 element; the results for 5 elements are identical).

Again, it is remarkable that the torque is perfectly matched, although the shear stress at the integration points is 6 % off. This leads to shear values at the vertex nodes which are 19 % off. Interpolation to the facial integration points yields shear stresses of -0.305 MPa. Integration of these stresses finally leads to the perfect torque values. The torsion angle at the end of the beam is 7 % off.

Summarizing, one can state that the use of C3D20R elements leads to quite remarkable results:

- For a rectangular cross section:
 - the section forces are correct
 - the stresses at the integration points are correct
 - the displacements for bending are correct, provided enough elements are used
 - the torsion angle is somewhat off (15 %).
- For a circular cross section:
 - the shear force and torque section forces are correct
 - the bending moment is correct if enough elements are used

- the displacements for bending are correct, provided enough elements are used
- the torsion angle is somewhat off (7 %).

It is generally recommended to calculate the stresses from the section forces. The only drawback is the C3D20R element may lead to hourglassing, leading to weird displacements. However, the mean of the displacements across the cross section is usually fine. An additional problem which can arise is that nonlinear geometric calculations may not converge due to this hourglassing. This is remedied in CalculiX by slightly perturbing the coordinates of the expanded nodes (by about 0.1 %).

A similar exercise was performed for the B32 element, however, the results were quite discouraging. The section forces were, especially for bending, way off.

5.15 Reinforced concrete cantilever beam

Purpose of this exercise is to calculate the stresses in a reinforced concrete cantilever beam due to its own weight. Special issues in this type of problem are the treatment of the structure as a composite and the presence of a compression-only material (the concrete).

The input deck runs like:

```
*NODE, NSET=Nall
  1,1.000000000000e+01,0.000000000000e+00,0.000000000000e+00
...
*ELEMENT, TYPE=S8R, ELSET=Eall
   1,    1,    2,    3,    4,    5,    6,    7,    8
   2,    2,    9,   10,    3,   11,   12,   13,    6
...
** Names based on left
*NSET,NSET=Nleft
49,
50,
52,
** Names based on right
*NSET,NSET=Nright
1,
4,
8,
*MATERIAL,NAME=COMPRESSION_ONLY
*USER MATERIAL,CONSTANTS=2
  1.4e10,    1.e5
*DENSITY
2350.
*MATERIAL,NAME=STEEL
```

```

*ELASTIC
210000.e6,.3
*DENSITY
7800.
*SHELL SECTION,ELSET=Ea11,COMPOSITE
.09,,COMPRESSION_ONLY
.01,,STEEL
.1,,COMPRESSION_ONLY
.1,,COMPRESSION_ONLY
.1,,COMPRESSION_ONLY
.1,,COMPRESSION_ONLY
.1,,COMPRESSION_ONLY
.1,,COMPRESSION_ONLY
.1,,COMPRESSION_ONLY
.1,,COMPRESSION_ONLY
.1,,COMPRESSION_ONLY
.1,,COMPRESSION_ONLY
*BOUNDARY
Nleft,1,6
*STEP,NLGEOM
*STATIC
1.,1.
*DLOAD
Ea11,GRAV,9.81,0.,0.,-1.
*NODE FILE
U
*EL FILE
S
*END STEP

```

The beam has a cross section of $1 \times 1 \text{ m}^2$ and a length of 10 m. The density of concrete is 2350 kg/m^3 , whereas the density of steel is 7800 kg/m^3 . The Young's moduli are 14000 MPa and 210000 MPa, respectively. Steel is provided only on the top of the beam (tension side of the beam) at a distance of 9.5 cm from the upper surface. Its layer thickness is 1 cm (in reality the steel is placed within the concrete in the form of bars. The modeling as a thin layer is an approximation. One has to make sure that the complete section of the bars equals the section of the layer). Using the composite feature available for shell structures significantly simplifies the input. Notice that this feature is not (yet) available for beam elements. Consequently the beam was modeled as a plate with a width of 1 m and a length of 10 m. Underneath the *SHELL SECTION card the thickness of the layers and their material is listed, starting at the top of the beam. The direction (from top to bottom) is controlled by the direction of the normal on the shell elements (which is controlled by the order in which the elements' nodes are listed underneath the *ELEMENT card). In a composite shell there are two integration points across each layer. Use of the S8R element or S6 element is mandatory. In order to capture the location of the neutral axis

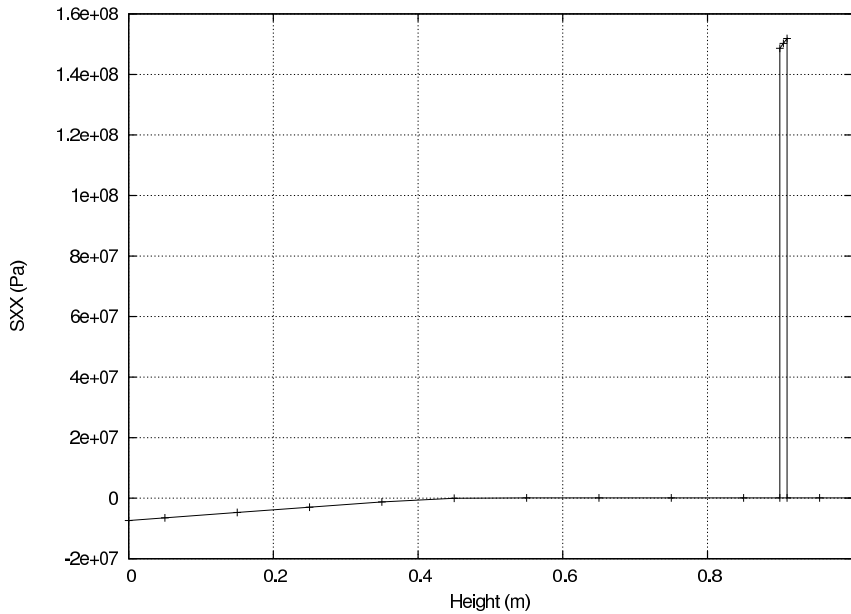

Figure 39: Axial stress across the height of the beam at the fixed end

several layers were used to model the concrete part of the section (in total 10 layers for the concrete and 1 for the steel).

Concrete cannot sustain tension whereas it is largely linear elastic under pressure. This can be modeled with the `COMPRESSION_ONLY` material model. In CalculiX this is an example of a user material. The name of user materials has to start with a fixed character set, in this case `"COMPRESSION_ONLY"`. The remaining 64 characters (a material name can be at most 80 characters long) can be freely chosen. In the present input deck no extra characters were selected. Choosing extra characters is needed if more than 1 compression-only material is present (in order to distinguish them). The `"COMPRESSION_ONLY"` material is characterized by 2 constants, the first is Young's modulus, the second is the maximum tensile stress the user is willing to allow, in our case 0.1 MPa (SI-units are used).

Using simple beam theory ([68]) leads to a tensile stress of 152.3 MPa in the steel and a maximum compressive stress of 7.77 MPa at the lower edge of the concrete. The finite element calculation (Figure 39) predicts 152 MPa and 7.38 MPa, respectively, which is quite close. In CalculiX, the graphical output of composite structures is always expanded into three dimensions. In Figure 40 one notices the correct dimension of the composite and the high tensile stresses in the thin steel layer.

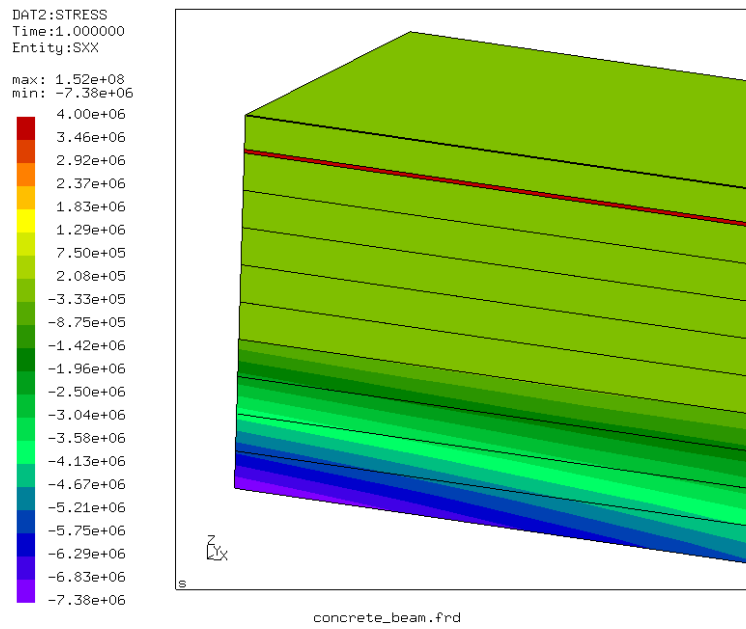

Figure 40: Axial stress across the height of the beam at the fixed end

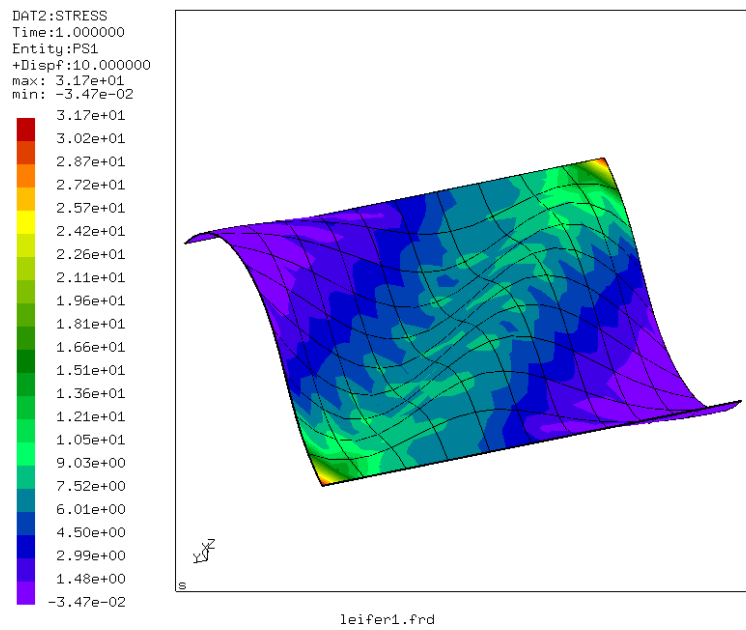

Figure 41: Maximum principal stress in the deformed sheet

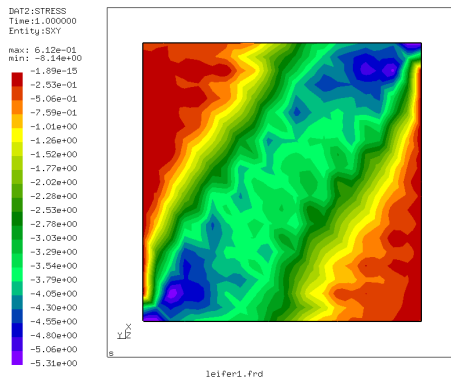

Figure 42: Shear stress in the isotropic simulation

5.16 Wrinkling of a thin sheet

The input decks for this problem can be found in the test suite as `leifer1.inp` and `leifer2.inp`. It was first devised by J. Leifer in 2003. The structure is a thin square sheet with an edge length of 229 mm and a thickness of 0.0762 mm. It is fixed on one side and moved parallel to this side on the opposite side by 1 mm. Young's modulus and Poisson's coefficient are 3790 MPa and 0.38, respectively. Experimental evidence points to the creation of wrinkles due to this shear deformation.

Here, two approaches are described to simulate this experiment. In both cases the sheet is simulated using quadratic shell elements. In the first simulation (`leifer1`) the material is considered as a linear elastic isotropic material, and wrinkling occurs due to natural buckling processes in the sheet. To enhance this buckling, the coordinates in the direction perpendicular to the sheet (this is the z -direction in our simulation) are slightly perturbed in a aleatoric way (look at the coordinates in the input deck to verify this). Furthermore, the simulation is performed in a dynamic procedure starting with very small time steps. Figure 41 shows the maximum principal stress in the deformed sheet (the edge at $x=0$ was fixed, the edge at $x=229$ was moved 1 mm in negative y -direction). One nicely notices the wrinkles. A look at the smallest principal stress shows that there are virtually no pressure stresses in the sheet: they were removed by buckling. A disadvantage of this kind of simulation is the very long computational time (336 increments for a step time of 1!).

The absence of pressure stress points to a second way of obtaining the correct stress distribution: instead of simulating the material as isotropic, one can use a tension-only material model (`leifer2`). This has the advantage that convergence is much faster (small computational times). Figures 42 and 43 compare the shear stress of both simulations: they match quite nicely (the shear stress distribution in an isotropic simulation without wrinkling is totally different). The same applies to the other stress components. The use of a tension-only material,

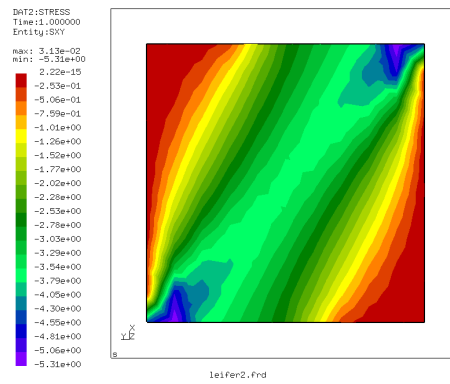

Figure 43: Shear stress in the tension-only simulation

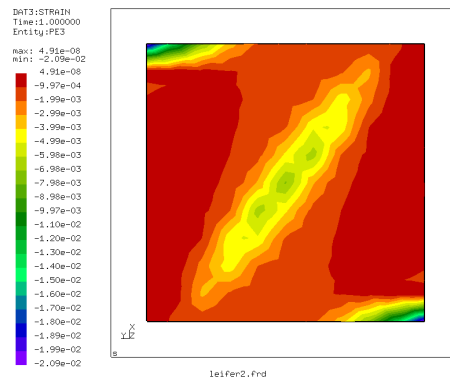

Figure 44: Minimum principal strain in the tension-only simulation

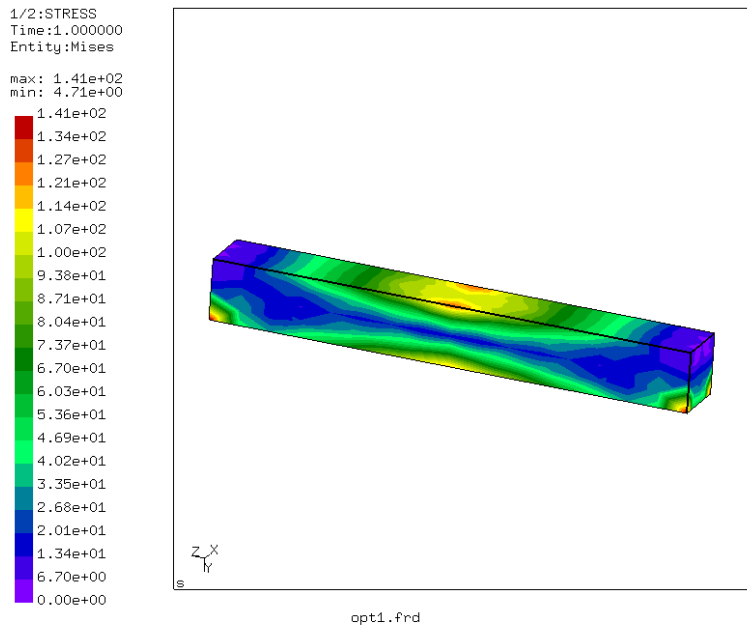

Figure 45: von Mises stress in the starting geometry of the beam

however, does not lead to out-of-plane deformations. Here, wrinkling can only be derived indirectly by looking at the smallest principal strain (Figure 44). The large negative values point to the existence of wrinkles.

5.17 Optimization of a simply supported beam

In this section the optimization of a simply supported beam w.r.t. stress and subject to a non-increasing mass constraint is treated. This example shows how an optimization might be performed, the procedure itself is manually and by no way optimized. For industrial applications one would typically write generally applicable scripts taking care of the manual steps explained here.

This example uses the files `opt1.inp`, `opt1.sh`, `opt2.fbl` and `op3.inp`, all available in the CalculiX test suite. File `opt1.inp` contains the geometry and the loading of the problem at stake: the structure is a beam simply supported at its ends (hinge on one side, rolls on the other) and a point force in the middle. The von Mises stresses are shown in Figure 45.

The target of the optimization is to reduce the stresses in the beam. The highest stresses occur in the middle of the beam and at the supports (cf. Figure 45). Since the stresses at the supports will not decrease due to a geometrical change of the beam (the peak stresses at the supports are caused by the point-like nature of the support) the set of design variables (i.e. the nodes in which the geometry of the beam is allowed to change during the optimization) is chosen as

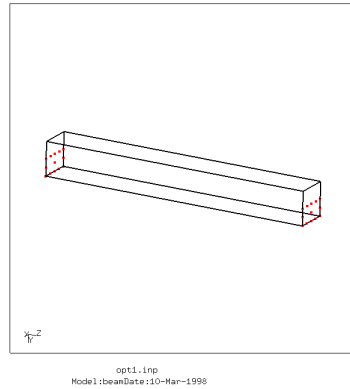

Figure 46: Nodes excluded from the set of design variables

all nodes in the beam except for a set of nodes in the vicinity of the supports. These latter nodes are shown in Figure 46.

In order to perform an optimization one has to determine the sensitivity of the objective w.r.t. the design variables taking into account any constraints for every intermediate design step (iteration) of the optimization. The objective and the constraints are generally design responses. First, the sensitivity of each design response is determined in a **SENSITIVITY* step. Then, one design response is selected as objective and one or more as constraints in a **FEASIBLE DIRECTION* step. In the latter step the sensitivity of the unconstrained objective is combined with the sensitivity of the constraints in order to obtain the sensitivity of the constrained objective.

The design variables were already discussed and constitute the set of nodes in which the design is allowed to change. In the input deck for the present example this is taken care of by the lines:

```
*DESIGNVARIABLES,TYPE=COORDINATE
DESIGNNODES
```

“DESIGNNODES” is a nodal set containing the design nodes as previously discussed. For optimization problems in which the geometry of the structure is to be optimized the type is *COORDINATE*. Alternatively, one could optimize the orientation of anisotropic materials in a structure, this is covered by *TYPE=ORIENTATION*.

The objective is the design response one would like to minimize. In the present example the Kreisselmeier-Steinhauser function calculated from the von Mises stress in all design nodes (cf. **DESIGN RESPONSE* for the definition of this function) is to be minimized. Again, the support nodes are not taken into account because of the local stress singularity. The objective is taken care of by the lines:

```
*DESIGN RESPONSE, NAME=STRESS_RESP
```



```
MISESSTRESS,DESIGNNODES,10.,100.
```

in the sensitivity step and

```
*OBJECTIVE,TARGET=MIN
STRESS_RESP
```

in the feasible direction step in the input deck. Notice that the node set used to define the Kreisselmeier-Steinhauser function (second entry underneath the *DESIGN RESPONSE card) does not have to coincide with the set of design variables. The third and fourth entry underneath the *DESIGN RESPONSE card constitute parameters in the Kreisselmeier-Steinhauser function. Specifically, the fourth entry is a reference stress value and should be of the order of magnitude of the actual maximum stress in the model. The third parameter allows to smear the maximum stress value in a less or more wide region of the model.

In addition to the objective function (only one objective function is allowed) one or more constraints can be defined in the feasible direction step. In the actual example the mass of the beam should not increase during the optimization. This is taken care of by

```
*DESIGN RESPONSE, NAME=MASS_RESP
MASS,Ea11
```

in the sensitivity step and

```
*CONSTRAINT
MASS_RESP,LE,1.,
```

in the feasible direction step. For the meaning of the entries the reader is referred to *DESIGN RESPONSE and *CONSTRAINT. Notice that for this constraint to be active the user should have defined a density for the material at stake. Within CalculiX the constraint is linearized. This means that, depending on the increment size during an optimization, the constraint will not be satisfied exactly.

In the CalculiX run the sensitivity of the objective and all constraints w.r.t. the design variables is calculated. The sensitivity is nothing else but the first derivative of the objective function w.r.t. the design variables (similarly for the constraints), i.e. the sensitivity shows how the design response changes if the design variable is changed. For design variables of type COORDINATE the change of the design variables (i.e. the design nodes) is in a direction locally orthogonal to the geometry. So in our case the sensitivity of the stress tells us how the stress changes if the geometry is changed in direction of the local normal (similar with the mass CONSTRAINT). If the sensitivity is positive the stress increases while thickening the structure and vice versa. This sensitivity may be postprocessed by using a filter. In the present input deck (opt1.inp) the following filter is applied:

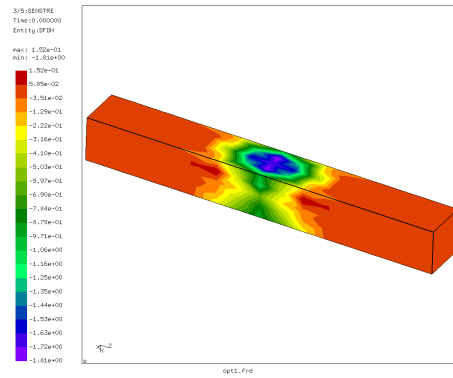

Figure 47: Stress sensitivity before filtering

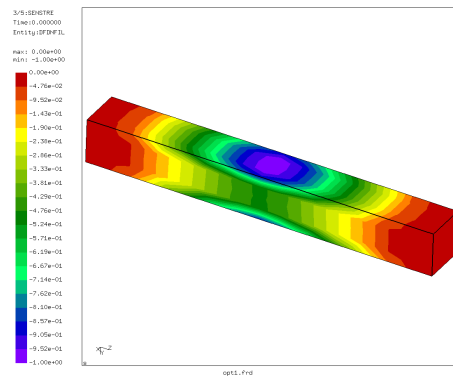

Figure 48: Stress sensitivity after filtering

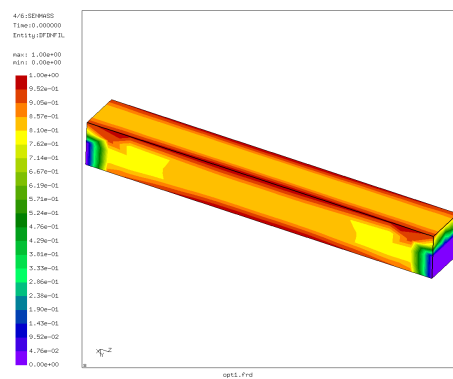

Figure 49: Mass sensitivity after filtering

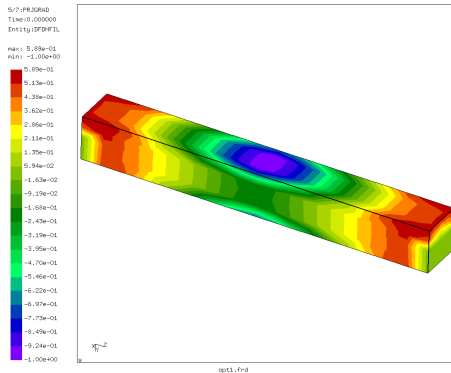

Figure 50: Stress sensitivity taking the mass constraint into account

```
*FILTER,TYPE=LINEAR,EDGE PRESERVATION=YES,DIRECTION WEIGHTING=YES
3.
```

The filter is linear with a radius of 3 (it can be visualized as a cone at each design variable in which the sensitivity is integrated and subsequently smeared), sharp corners should be kept (EDGE PRESERVATION=YES, cf. *FILTER) and surfaces with a clearly different orientation (e.g. orthogonal) are not taken into account while filtering (or taken into account to a lesser degree, DIRECTION WEIGHTING=YES). The filtering is applied to each design response separately. Figure 47 shows the stress sensitivity before filtering, Figure 48 the stress sensitivity after filtering and Figure 49 the mass sensitivity after filtering. All of this information is obtained by requesting SEN underneath the *NODE FILE card. Notice that the sensitivity is normalized after filtering.

After calculating the filtered sensitivities of the objective function and the constraints separately (this is done in the sensitivity step) they are joined by projecting the sensitivity of the active constraints on the sensitivity of the objective function (this is done in the feasible direction step). For a mesh modification size of 1 (parameter underneath the *FEASIBLE DIRECTION card) this results in Figure 50.

The sensitivities calculated in this way allow us to perform an optimization. The simplest concept is the steepest gradient algorithm in which the geometry is changed in the direction of the steepest gradient. In the present calculations only one gradient is calculated (the one in the direction of the local normal) since a geometry change parallel to the surface of the structure generally does not change the geometry at all. So the geometry is changed in the direction of the local normal by an amount to be defined by the user. It is usually a percentage of the local sensitivity, the so-called mesh modification size, to be defined underneath the *FEASIBLE DIRECTION card. Here, a mesh modification size of 10 % (i.e. 0.1).

In order to maintain a good quality mesh the other boundary nodes and the

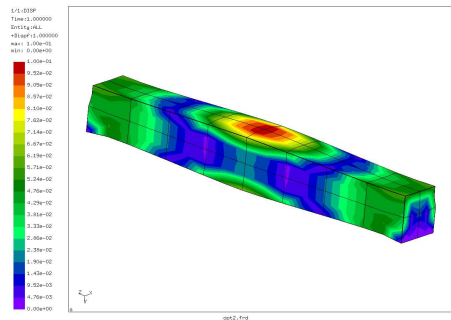

Figure 51: Deformed mesh after one iteration

internal nodes should be appropriately moved as well. This is taken care of by a subsequent linear elastic calculation with the sensitivity-based surface geometry change as boundary conditions. The corresponding input deck with the name `opt1.equ` is automatically generated within the `*FEASIBLE DIRECTION` step.

This input deck contains the original geometry of the beam. The sensitivity-based surface geometry change is imposed by `*BOUNDARY` statements.

Furthermore, preservation of sharp edges and corners in the original structure is taken care of by linear equations. In order to obtain a good quality mesh at the free surface the fictitious elastic modulus is decreased with increasing distance from the free surface. Before running `opt1.equ` it is copied by script `opt1.sh` into `opt2.inp`.

The resulting deformed mesh is shown in Figure 51. The beam was thickened in the middle, where the von Mises stresses were highest. This should lead to a decrease of the highest stress value. In order to check this, a new sensitivity calculation was done on the deformed structure. To that end the deformation calculated based on `opt2.inp` is superimposed on the coordinates (by a call to `opt2.fbl` in script `opt1.sh`) and stored as `opt3.inc`. This file is included in input deck `opt3.inp`, which apart from the coordinates is a copy of `opt1.inp`. The resulting von Mises stresses are shown in Figure 52. The von Mises stress in the middle of the lower surface of the beam has indeed decreased from 114 to about 80 (MPa if the selected units were mm, N, s and K). Further improvements can be obtained by running several iterations.

5.18 Mesh refinement of a curved cantilever beam

This example illustrates the use of the `*REFINE MESH` keyword card in order to refine a tetrahedral mesh based on some solution variable. The structure is a curved cantilever beam (Figure 53) meshed very coarsely using C3D10 elements. The left side of the beam is completely fixed in z -direction, the lower left node is furthermore fixed in x and y , the lower right node in y . A load of 9 force units is applied to the nodes in the right face of the beam in $+y$ direction. This leads to the normal stresses in z shown in the Figure. The beam experiences bending

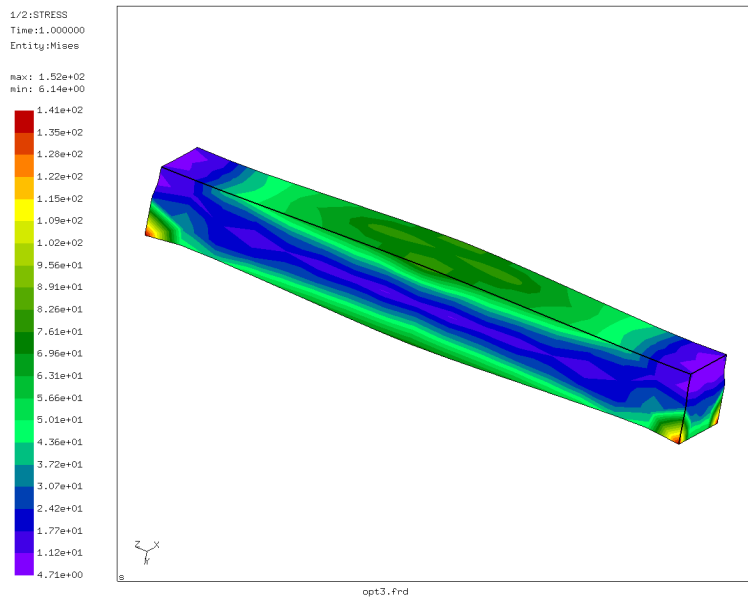

Figure 52: Mises stress after one iteration

leading to tensile stresses at the bottom and compressive stresses at the top. The input deck of the beam (circ10p.inp) is part of the CalculiX test suite.

Here, only the step information in the input deck is reproduced:

```
*STEP
*STATIC
*CLOAD
LOAD,2,1.
*NODE PRINT,NSET=FIX,TOTALS=ONLY
RF
*SECTION PRINT,SURFACE=Sfix,NAME=SP1
SOF,SOM
*NODE FILE
U
*EL FILE
S
*REFINE MESH,LIMIT=50.
S
*END STEP
```

It illustrates several possibilities to obtain the reaction forces. One way is to use the `*NODE PRINT` keyword card to request the storage of RF in the .dat file. It acts on a node set, in this case all nodes on the left surface of

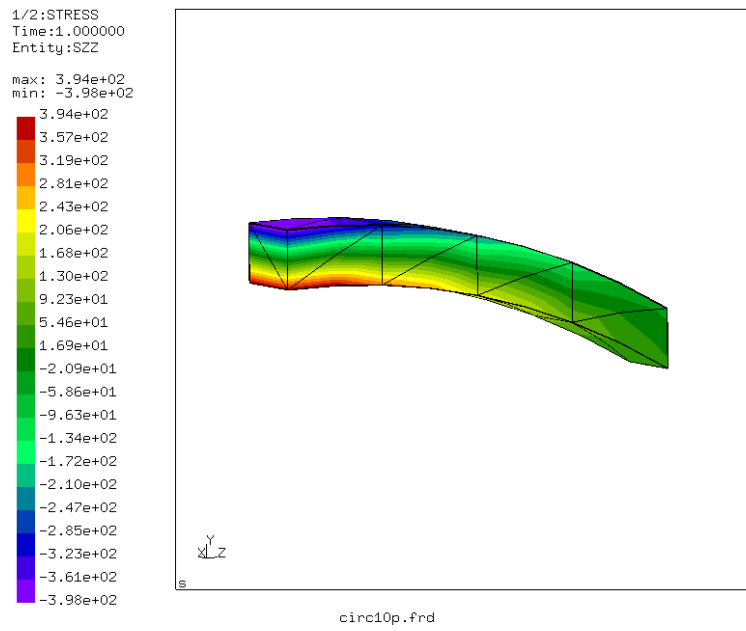

Figure 53: Normal stress in z-direction for the coarse mesh

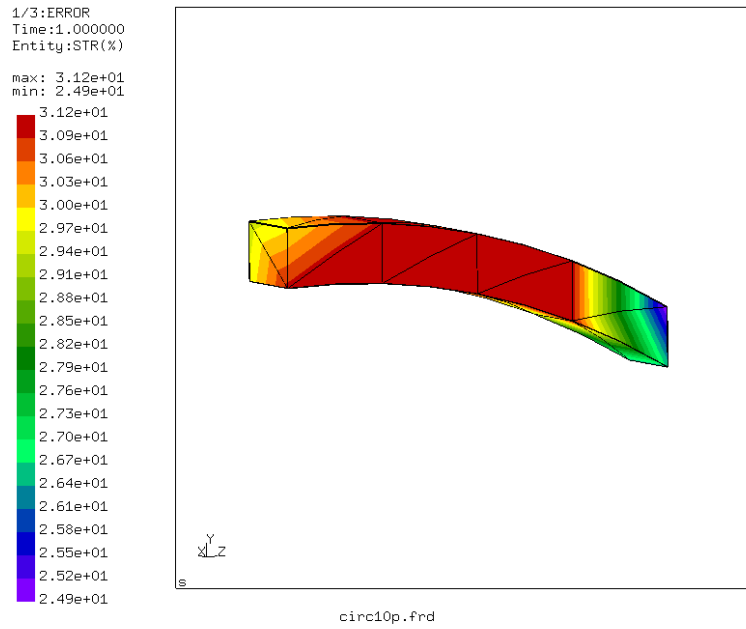

Figure 54: Error estimator for the coarse mesh

the beam. The parameter TOTALS=ONLY indicates that only the sum of the forces should be printed, not the individual contributions. The *NODE PRINT option works well if the adjacent elements of the nodal set are not subject to distributed loads, neither surface distributed loads (pressure) nor volumetric distributed loads (gravity, centrifugal forces). Else the value printed for RF will include part of these latter forces.

A second possibility is to define a facial surface and use SOF and SOM underneath the *SECTION PRINT card in order to request the forces and moments on this surface. The surface Sfix consists of all faces in the left surface of the beam. The forces and moments are obtained by integration across the surface.

The output in the .dat-file looks like:

```
total force (fx,fy,fz) for set FIX and time 0.100000E+01
      -9.372063E-13 -9.000000E+00  3.127276E-12

statistics for surface set SFIX and time 0.100000E+01

total surface force (fx,fy,fz) and moment about the origin(mx,my,mz)
      2.454956E+00 -7.226251E+00  1.377949E+01  7.236961E+01 -5.740438E+00 -4.957194E+00

center of gravity and mean normal
      5.000000E-01  5.000000E-01  0.000000E+00  0.000000E+00  0.000000E+00 -1.000000E+00

moment about the center of gravity(mx,my,mz)
      6.547987E+01  1.149306E+00 -1.165902E-01

area, normal force (+ = tension) and shear force (size)
      6.000000E+00 -1.377949E+01  7.631875E+00
```

From this one observes that the reaction force obtained by the *NODE PRINT statement is very accurate, however, the integration across the surface of the stresses is rather inaccurate: instead of 9 force units one obtains 7.23 units. The moment about the center of gravity is 65.5 [force][length] instead of the expected 72 [force][length] (the length of the beam is 8 length units).

The value of the error estimator is shown in Figure 54. Not surprisingly, the error is quite high, up to 30 %.

In order to obtain better results, an automatic stress-based refinement is triggered by the *REFINE MESH,LIMIT=50 card. The field on which the re-

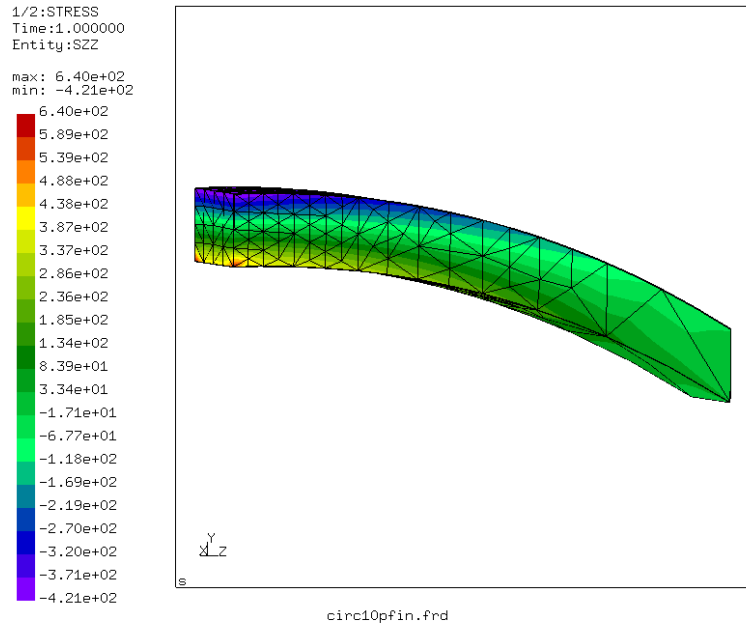

Figure 55: Normal stress in z-direction for the fine mesh

finement is based is listed underneath this card. “S” means that the Mises stress will be used. The Mises stress for this example reaches values of about 400 stress units, so a refinement of up to a factor of 8 is locally possible (a refinement limit of 50. was chosen). In the current version of CalculiX up to three iterations are performed, each of which allows for a refinement by a factor of two. The refinements are always applied to a version of the original mesh in which any quadratic elements are replaced by linear ones (C3D10 by C3D4), i.e. the middle nodes are not taken into account. The results of these refinement iterations are stored as input decks (containing only the mesh) in files finemesh.inp0, finemesh.inp1 and finemesh.inp2. After generating the mesh stored in finemesh.inp2, the program generates midnodes for all elements if the input deck contained at least one quadratic element. All nodes are subsequently projected onto the faces of the original mesh. This means that the geometry is basically described by the outer surface of the mesh in the input deck. Elements in the input deck other than tetrahedral elements remain untouched. The resulting projected mesh is stored as input deck in jobname.fin. It contains only the refined mesh (nodes and elements).

Running the circ10p input deck and reapplying the necessary boundary and loading conditions (this has to be done by hand) leads to the input deck circ10pfin.inp (also part of the CalculiX test examples). Running this deck leads to the normal z-stresses in Figure 55 and the error in Figure 56.

The mesh has been refined near the left face of the beam, where the stresses

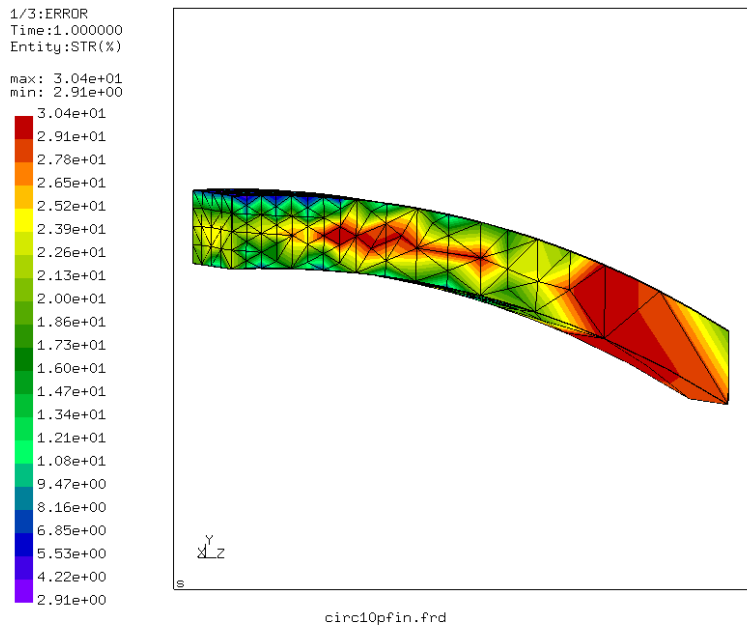

Figure 56: Error estimator for the fine mesh

were highest. The resulting elements are quadratic elements and the curvature of the original mesh has been nicely kept.

The compressive stresses are slightly increased, while the tensile stresses are now much more localized about the nodes fixed in y-direction. The overall level, however, is similar. The stress error is about the same as for the coarse mesh, however, at those locations where the stress is high, the error is now low, about 5 % instead of 30 %. These are the locations of interest.

The output for the reaction forces in the .dat file looks like:

```
total force (fx,fy,fz) for set FIX and time 0.1000000E+01
```

```
3.221013E-12 -9.000000E+00 7.356782E-12
```

```
statistics for surface set SFIX and time 0.1000000E+01
```

```
total surface force (fx,fy,fz) and moment about the origin(mx,my,mz)
```

```
1.512388E-01 -9.252627E+00 -7.227514E-01 7.175724E+01 1.563390E-01 -4.206416E+00
```

center of gravity and mean normal

5.000000E-01 5.000000E-01 4.014218E-19 -4.263022E-20 4.286885E-20 -1.000000E+00

moment about the center of gravity(mx,my,mz)

7.211862E+01 -2.050367E-01 4.955169E-01

area, normal force (+ = tension) and shear force (size)

6.000000E+00 7.227514E-01 9.253863E+00

The nodal output is again very accurate, while the section output has clearly improved: the total reaction force is now -9.25 force units, the moment about the center of gravity is 72.12 [force][length]. The finer mesh leads to more accurate nodal stresses, which are the ones which have been used to determined the section forces.

6 Theory

The finite element method is basically concerned with the determination of field variables. The most important ones are the stress and strain fields. As basic measure of strain in CalculiX the Lagrangian strain tensor E is used for elastic media, the deviatoric elastic left Cauchy-Green tensor for incremental plasticity, the logarithmic (or Hencky) strain [9] for some other plasticity models as deformation plasticity and Johnson-Cook hardening and linear strains where appropriate, i.e. for small deformations combined with small rotations. The Lagrangian strain satisfies ([25]):

$$E_{KL} = (U_{K,L} + U_{L,K} + U_{M,K}U_{M,L})/2, \quad K, L, M = 1, 2, 3 \quad (2)$$

where U_K are the displacement components in the material frame of reference and repeated indices imply summation over the appropriate range. In a linear analysis, this reduces to the familiar form:

$$\tilde{E}_{KL} = (U_{K,L} + U_{L,K})/2, \quad K, L = 1, 2, 3. \quad (3)$$

The deviatoric elastic left Cauchy-Green tensor is defined by ([87]):

$$\bar{b}_{kl}^e = J^{e-2/3} x_{k,K}^e x_{l,K}^e \quad (4)$$

where J^e is the elastic Jacobian and $x_{k,K}^e$ is the elastic deformation gradient. Finally, the logarithmic strain satisfies:

$$e_{\ln} := \sum_i \ln \lambda_i \mathbf{n}_i \otimes \mathbf{n}_i, \quad (5)$$

where λ_i^2 are the eigenvalues of the Cauchy-Green tensor $\mathbf{C} := \mathbf{F}^T \cdot \mathbf{F}$ and \mathbf{n}_i are obtained from the eigenvectors \mathbf{N}_i of \mathbf{C} through

$$\mathbf{n}_i = \mathbf{R} \cdot \mathbf{N}_i, \quad (6)$$

where \mathbf{R} is the rotation tensor obtained from the well known decomposition of the deformation gradient \mathbf{F} into a product of an orthogonal matrix \mathbf{R} and a symmetric matrix \mathbf{U} in the form $\mathbf{F} = \mathbf{R} \cdot \mathbf{U}$. The above formulas apply to Cartesian coordinate systems.

The stress measure consistent with the Lagrangian strain is the second Piola-Kirchhoff stress \mathbf{S} . This stress, which is internally used in CalculiX for all applications (the so-called total Lagrangian approach, see [9]), can be transformed into the first Piola-Kirchhoff stress \mathbf{P} (the so-called engineering stress, a non-symmetric tensor) and into the Cauchy stress $\boldsymbol{\sigma}$ (true stress). All CalculiX input (e.g. distributed loading) and output is in terms of true stress. The stress measures are related by:

$$\mathbf{P} = J\mathbf{F}^{-1} \cdot \boldsymbol{\sigma} \quad (7)$$

and

$$\mathbf{S} = J\mathbf{F}^{-1} \cdot \boldsymbol{\sigma} \cdot \mathbf{F}^{-T}, \quad (8)$$

where $J = \det(\mathbf{F})$.

The treatment of the thermal strain depends on whether the analysis is geometrically linear or nonlinear. For isotropic material the thermal strain tensor amounts to $\bar{\alpha}\Delta T\mathbf{I}$, where $\bar{\alpha}$ is the (secant) expansion coefficient, ΔT is the temperature change since the initial state and \mathbf{I} is the second order identity tensor. For geometrically linear calculations the thermal strain is subtracted from the total strain to obtain the mechanical strain:

$$\tilde{\mathbf{E}}_{KL}^{\text{mech}} = \tilde{\mathbf{E}}_{KL} - \bar{\alpha}\Delta T\delta_{KL}. \quad (9)$$

In a nonlinear analysis the thermal strain is subtracted from the deformation gradient in order to obtain the mechanical deformation gradient. Indeed, assuming a multiplicative decomposition of the deformation gradient one can write:

$$d\mathbf{x} = \mathbf{F} \cdot d\mathbf{X} = \mathbf{F}_{\text{mech}} \cdot \mathbf{F}_{\text{th}} \cdot d\mathbf{X}, \quad (10)$$

where the total deformation gradient \mathbf{F} is written as the product of the mechanical deformation gradient and the thermal deformation gradient. For isotropic materials the thermal deformation gradient can be written as $\mathbf{F}_{\text{th}} = (1 + \bar{\alpha}\Delta T)\mathbf{I}$ and consequently:

$$\mathbf{F}_{\text{th}}^{-1} \approx (1 - \bar{\alpha}\Delta T)\mathbf{I}. \quad (11)$$

Therefore one obtains:

$$\begin{aligned}
(F_{\text{mech}})_{kK} &\approx F_{kK}(1 - \bar{\alpha}\Delta T) = (1 + u_{k,K})(1 - \bar{\alpha}\Delta T) \\
&\approx 1 + u_{k,K} - \bar{\alpha}\Delta T.
\end{aligned} \tag{12}$$

Based on the mechanical deformation gradient the mechanical Lagrange strain is calculated and subsequently used in the material laws:

$$2\mathbf{E}_{\text{mech}} = \mathbf{F}_{\text{mech}}^T \cdot \mathbf{F}_{\text{mech}} - \mathbf{I}. \tag{13}$$

Since the stretches λ are the eigenvalues of the deformation gradient, subtracting $\bar{\alpha}\Delta T\mathbf{I}$ from \mathbf{F} amounts to subtracting $\bar{\alpha}\Delta T$ from $\lambda = L/L_0 = 1 + \Delta L/L_0$. Therefore, the thermal strain get the meaning of a length change divided by an initial length. Infinitesimally one obtains:

$$\frac{dL}{L_0} = \alpha dT, \tag{14}$$

leading to

$$\begin{aligned}
\frac{L - L_0}{L_0} &= \int_{T_0}^T \alpha(\xi) d\xi \\
&=: \bar{\alpha}(T)(T - T_0) \\
&= \bar{\alpha}(T)\Delta T,
\end{aligned} \tag{15}$$

from which

$$L = L_0(1 + \bar{\alpha}(T)\Delta T). \tag{16}$$

Here, T_0 is the temperature for which the specimen length is L_0 , α is the instantaneous or tangent expansion coefficient and $\bar{\alpha}$ is the secant expansion coefficient. We observe that the extension is linear in the temperature. This is also the way in which the expansion coefficients are usually measured, i.e. with respect to the initial specimen length.

Notice that the same approach is taken in CalculiX for the calculation of the corotational logarithmic strain needed for an Abaqus User Material Routine. First, the thermal strain is subtracted from the total stretch to obtain the mechanical stretch and then the corotational logarithmic strain is built:

$$\hat{E}_{\text{ln,mech}} = \sum_i (\ln \lambda_i - \bar{\alpha}\Delta T) \mathbf{N}_i \otimes \mathbf{N}_i, \tag{17}$$

which implies

$$\frac{dL}{L} = \alpha dT, \tag{18}$$

leading to

$$\begin{aligned}\ln \frac{L}{L_0} &= \int_{T_0}^T \alpha(\xi) d\xi \\ &= \bar{\alpha}(T) \Delta T,\end{aligned}\tag{19}$$

or

$$L = L_0 \exp[\bar{\alpha}(T) \Delta T].\tag{20}$$

This establishes an exponential expansion relationship. This is fine, as long as the thermal strain was also measured according to Equation(18), i.e. with reference to the actual length. The latter approach, used by a lot of Finite Element codes requires linear expansion coefficients for linear calculations (using linear strain) and exponential ones for nonlinear geometric calculations (using logarithmic strain). The approach in CalculiX avoids this.

6.1 Node Types

There are three node types:

- 1D fluid nodes. These are nodes satisfying at least one of the following conditions:
 - nodes belonging to 1D network elements (element labels starting with D)
 - reference nodes in *FILM cards of type forced convection (label: F*FC).
 - reference nodes in *DLOAD cards of type nodal pressure (label: P*NP).
- 3D fluid nodes. These are nodes belonging to 3D fluid elements (element labels starting with F)
- structural nodes. Any nodes not being 1D fluid nodes nor 3D fluid nodes.

It is not allowed to create equations between nodes of different types.

6.2 Element Types

There are a lot of different elements implemented in CalculiX, therefore it is not always easy to select the right one. In general, one can say that the quadratic elements are the most stable and robust elements in CalculiX. If you are not a finite element specialist the use of quadratic elements is strongly suggested. This includes:

- hexahedral elements: C3D20R

- tetrahedral elements: C3D10
- axisymmetric elements: CAX8R
- plane stress elements: CPS8R
- plane strain elements: CPE8R
- shell elements: S8R
- beam elements: B32R

Other elements frequently exhibit unsatisfactory behavior in certain instances, e.g. the C3D8 element in bending states. Unless you are a specialist, do not use such elements. Detailed information is given underneath.

6.2.1 Eight-node brick element (C3D8 and F3D8)

The C3D8 element is a general purpose linear brick element, fully integrated (2x2x2 integration points). The shape functions can be found in [46]. The node numbering follows the convention of Figure 57 and the integration points are numbered according to Figure 58. This latter information is important since element variables printed with the *EL PRINT keyword are given in the integration points.

Although the structure of the element is straightforward, it should not be used in the following situations:

- due to the full integration, the element will behave badly for isochoric material behavior, i.e. for high values of Poisson's coefficient or plastic behavior.
- the element tends to be too stiff in bending, e.g. for slender beams or thin plates under bending. [109].

The F3D8 element is the corresponding fluid element.

6.2.2 Eight-node brick element with reduced integration (C3D8R)

The C3D8R element is a general purpose linear brick element, with reduced integration (1 integration point). The shape functions are the same as for the C3D8 element and can be found in [46]. The node numbering follows the convention of Figure 57 and the integration point is shown in Fig 59.

Due to the reduced integration, the locking phenomena observed in the C3D8 element do not show. However, the element exhibits other shortcomings:

- The element tends to be not stiff enough in bending.
- Stresses, strains.. are most accurate in the integration points. The integration point of the C3D8R element is located in the middle of the element. Thus, small elements are required to capture a stress concentration at the boundary of a structure.

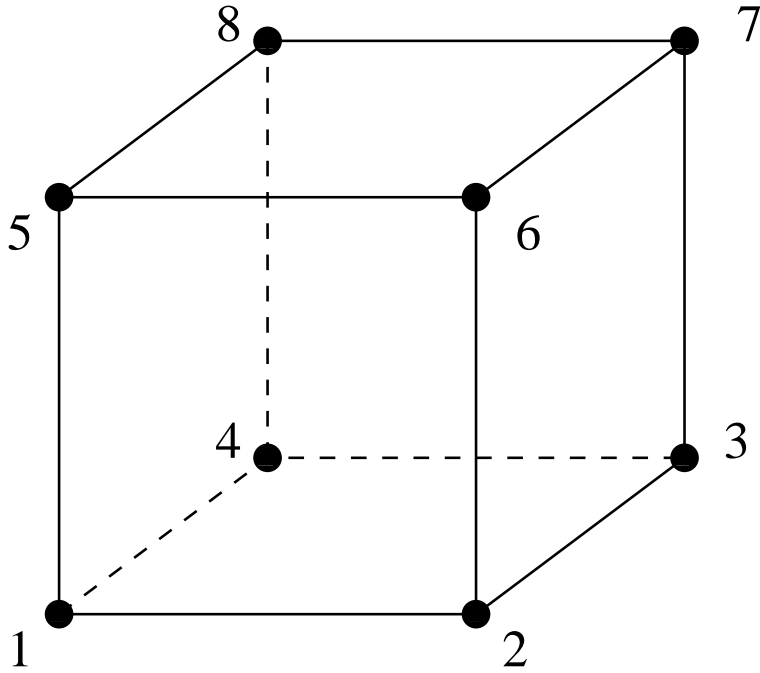

Figure 57: 8-node brick element

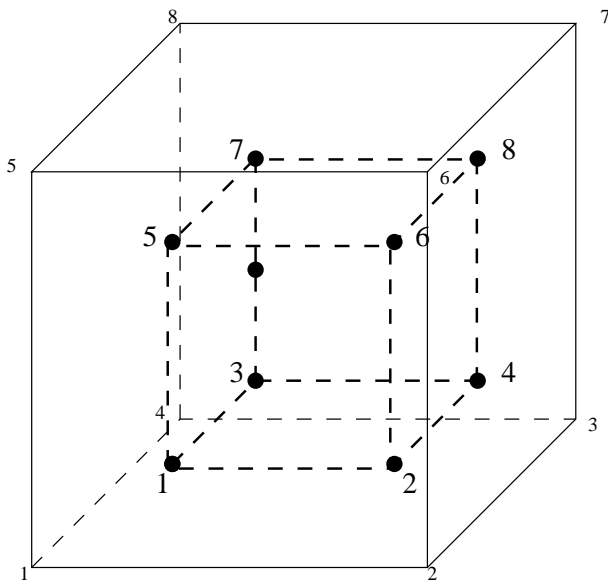

Figure 58: 2x2x2 integration point scheme in hexahedral elements

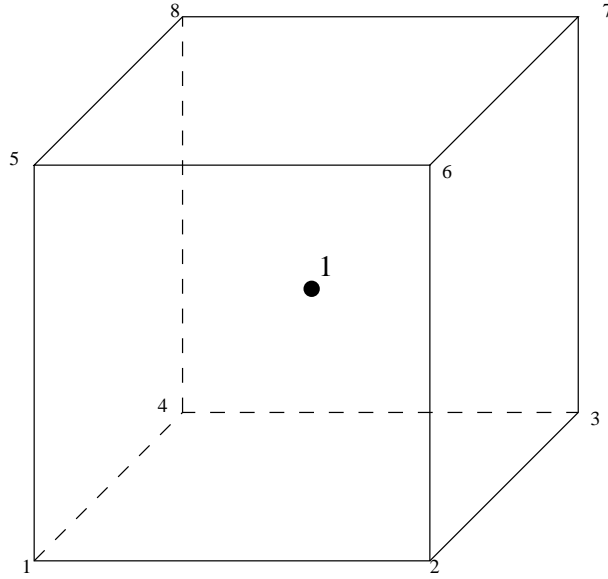

Figure 59: 1x1x1 integration point scheme in hexahedral elements

- There are 12 spurious zero energy modes leading to massive hourglassing: this means that the correct solution is superposed by arbitrarily large displacements corresponding to the zero energy modes. Thus, the displacements are completely wrong. Since the zero energy modes do not lead to any stresses, the stress field is still correct. In practice, the C3D8R element is not very useful without hourglass control. Starting with version 2.3 hourglass control is automatically activated for this element (using the theory in [28]), thus alleviating this issue.

6.2.3 Incompatible mode eight-node brick element (C3D8I)

The incompatible mode eight-node brick element is an improved version of the C3D8-element. In particular, shear locking is removed and volumetric locking is much reduced. This is obtained by supplementing the standard shape functions with so-called bubble functions, which have a zero value at all nodes and nonzero values in between. In CalculiX, the version detailed in [100] has been implemented. The C3D8I element should be used in all instances in which linear elements are subject to bending. Although the quality of the C3D8I element is far better than the C3D8 element, the best results are usually obtained with quadratic elements (C3D20 and C3D20R). The C3D8I element is not very good when subjected to torsion. Since the B31 element is expanded into a C3D8I element this also applies to the B31 element.

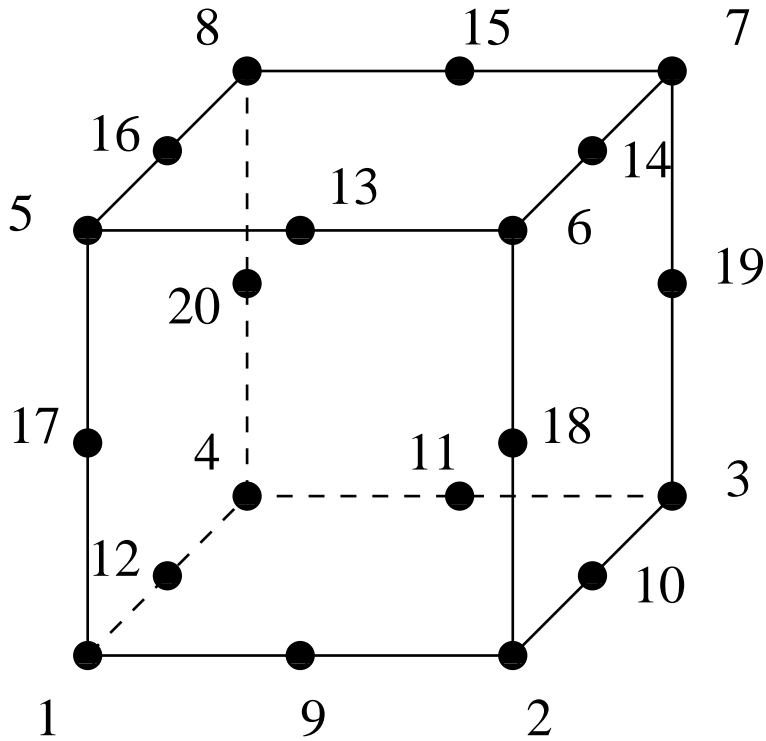

Figure 60: 20-node brick element

6.2.4 Twenty-node brick element (C3D20)

The C3D20 element is a general purpose quadratic brick element ($3 \times 3 \times 3$ integration points). The shape functions can be found in [46]. The node numbering follows the convention of Figure 60 and the integration scheme is given in Figure 61.

This is an excellent element for linear elastic calculations. Due to the location of the integration points, stress concentrations at the surface of a structure are well captured. However, for nonlinear calculations the element exhibits the same disadvantages as the C3D8 element, albeit to a much lesser extent:

- due to the full integration, the element will behave badly for isochoric material behavior, i.e. for high values of Poisson's coefficient or plastic behavior.
- the element tends to be too stiff in bending, e.g. for slender beams or thin plates under bending. [109].

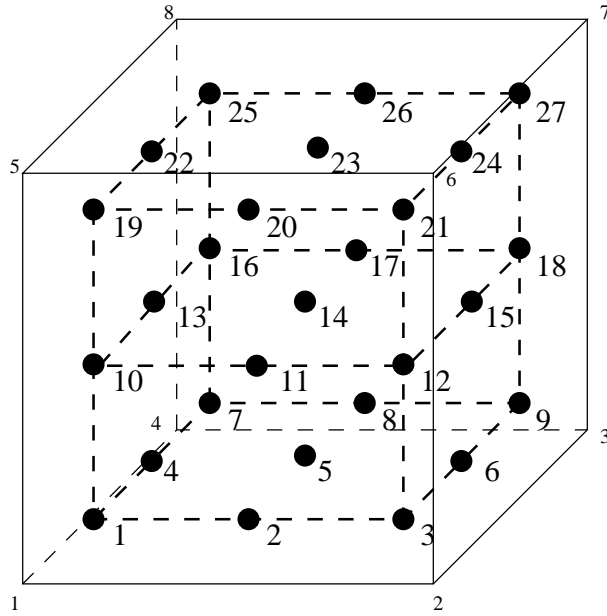

Figure 61: 3x3x3 integration point scheme in hexahedral elements

6.2.5 Twenty-node brick element with reduced integration (C3D20R)

The C3D20R element is a general purpose quadratic brick element, with reduced integration (2x2x2 integration points). The shape functions can be found in [46]. The node numbering follows the convention of Figure 60 and the integration scheme is shown in Figure 58.

The element behaves very well and is an excellent general purpose element (if you are setting off for a long journey and you are allowed to take only one element type with you, that's the one to take). It also performs well for isochoric material behavior and in bending and rarely exhibits hourglassing despite the reduced integration (hourglassing generally occurs when not enough integration points are used for numerical integration and spurious modes pop up resulting in crazy displacement fields but correct stress fields). The reduced integration points are so-called superconvergent points of the element [7]. Just two caveats:

- the integration points are about one quarter of the typical element size away from the boundary of the element, and the extrapolation of integration point values to the nodes is trilinear. Thus, high stress concentrations at the surface of a structure might not be captured if the mesh is too coarse.
- all quadratic elements cause problems in node-to-face contact calculations, because the nodal forces in the vertex nodes equivalent to constant pressure on an element side (section 6.11.2) are zero or have the opposite sign of those in the midside nodes. This problem seems to be solved if

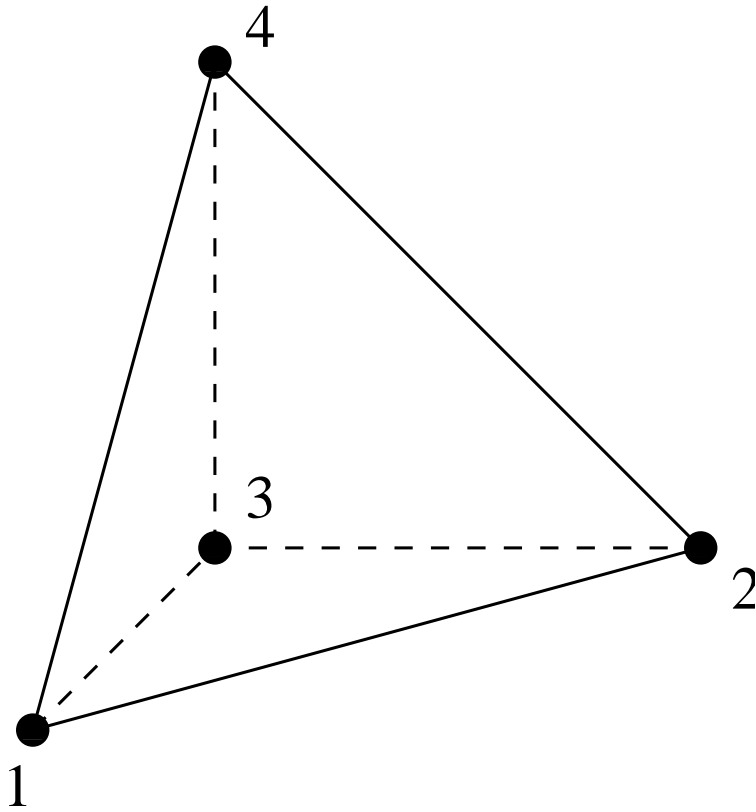

Figure 62: 4-node tetrahedral element

face-to-face penalty or mortar contact is used.

6.2.6 Four-node tetrahedral element (C3D4 and F3D4)

The C3D4 is a general purpose tetrahedral element (1 integration point). The shape functions can be found in [109]. The node numbering follows the convention of Figure 62.

This element is included for completeness, however, it is not suited for structural calculations unless a lot of them are used (the element is too stiff). Please use the 10-node tetrahedral element instead.

The F3D4 element is the corresponding fluid element.

6.2.7 Ten-node tetrahedral element (C3D10)

The C3D10 element is a general purpose tetrahedral element (4 integration points). The shape functions can be found in [109]. The node numbering follows the convention of Figure 63.

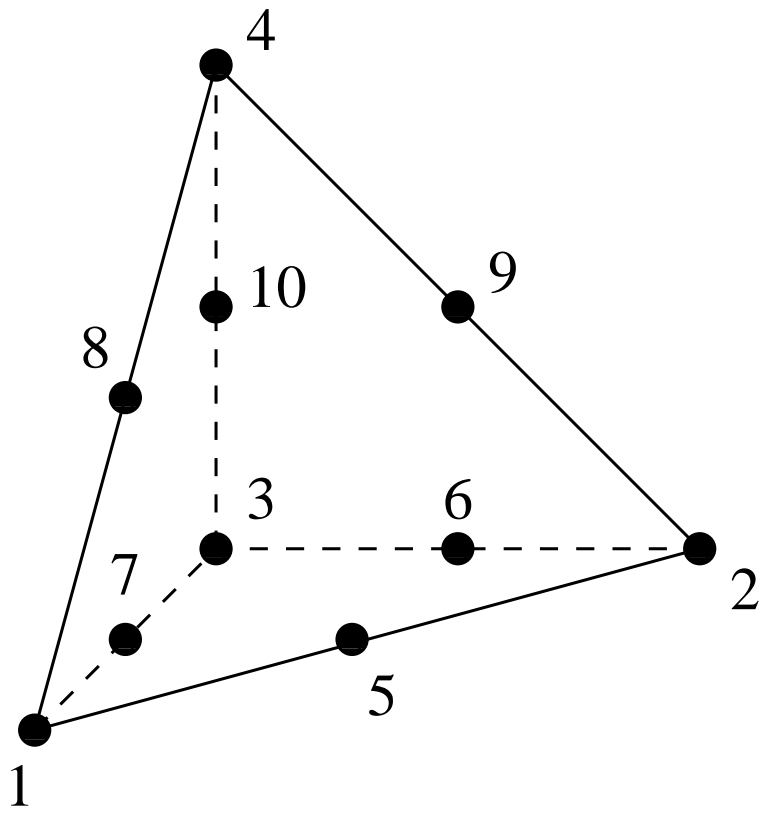

Figure 63: 10-node tetrahedral element

The element behaves very well and is a good general purpose element, although the C3D20R element yields still better results for the same number of degrees of freedom. The C3D10 element is especially attractive because of the existence of fully automatic tetrahedral meshers.

6.2.8 Modified ten-node tetrahedral element (C3D10T)

The C3D10T element is identical to the C3D10 element except for the treatment of thermal strains. In a regular C3D10 element both the initial temperatures and the displacements are interpolated quadratically, which leads to quadratic thermal strains and linear total strains (since the total strain is the derivative of the displacements). The mechanical strain is the total strain minus the thermal strain, which is consequently neither purely linear nor purely quadratic. This discrepancy may lead to a checkerboard pattern in the stresses, which is observed especially in the presence of high initial temperature gradients. To alleviate this the initial temperatures are interpolated linearly within the C3D10T element.

Notice that the linear interpolation of the initial temperatures is standard for the C3D20 and C3D20R element. For the C3D10 element it is not to keep the compatibility with ABAQUS.

6.2.9 Six-node wedge element (C3D6 and F3D6)

The C3D6 element is a general purpose wedge element (2 integration points). The shape functions can be found in [1]. The node numbering follows the convention of Figure 64.

This element is included for completeness, however, it is probably not very well suited for structural calculations unless a lot of them are used. Please use the 15-node wedge element instead.

The F3D6 element is the corresponding fluid element.

6.2.10 Fifteen-node wedge element (C3D15)

The C3D15 element is a general purpose wedge element (9 integration points). The shape functions can be found in [1]. The node numbering follows the convention of Figure 65.

The element behaves very well and is a good general purpose element, although the C3D20R element yields still better results for the same number of degrees of freedom. The wedge element is often used as fill element in “automatic” hexahedral meshers.

6.2.11 Three-node shell element (S3)

This is a general purpose linear triangular shell element. For the node numbering and the direction of the normal to the surface the reader is referred to the quadratic six-node shell element (S6) in Figure 66 (just drop the middle nodes).

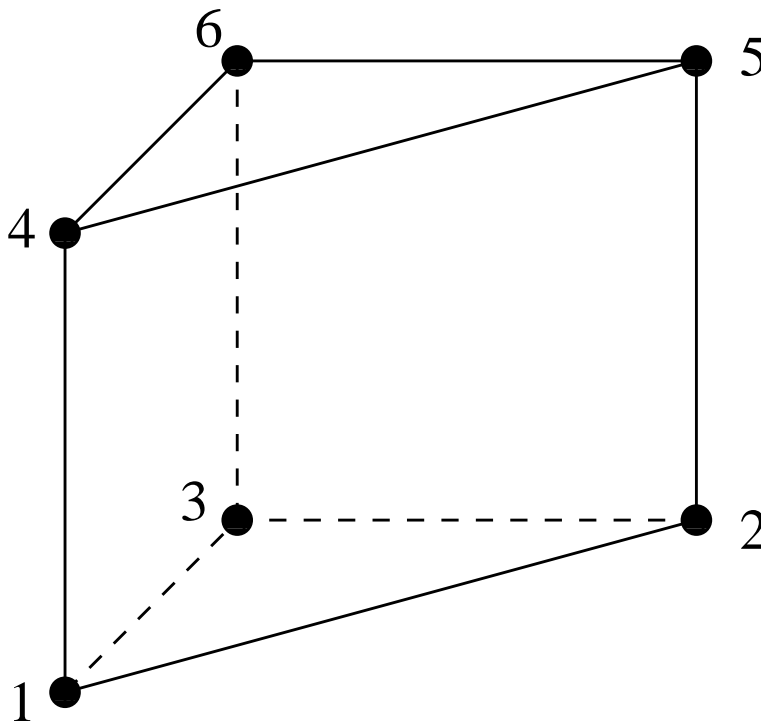

Figure 64: 6-node wedge element

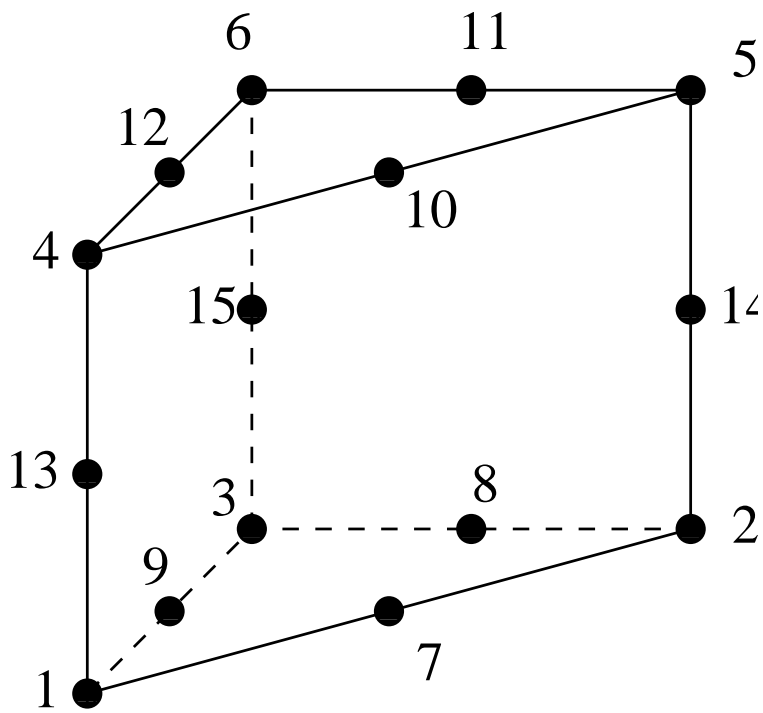

Figure 65: 15-node wedge element

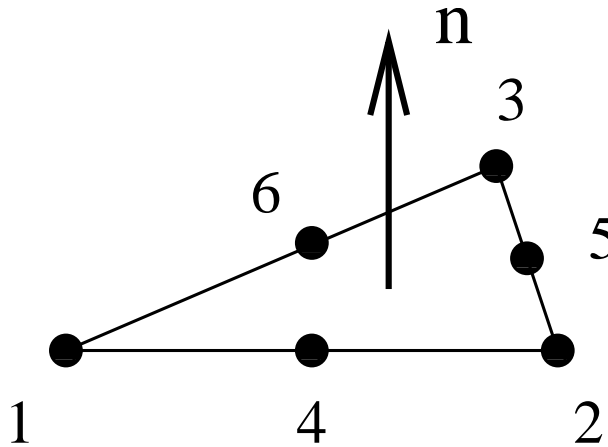

Figure 66: 6-node triangular element

In CalculiX, three-node shell elements are expanded into three-dimensional C3D6 wedge elements. The way this is done can be derived from the analogous treatment of the S6-element in Figure 67 (again, drop the middle nodes). For more information on shell elements the reader is referred to the eight-node shell element S8.

6.2.12 Four-node shell element (S4 and S4R)

This is a general purpose linear 4-sided shell element. For the node numbering and the direction of the normal to the surface the reader is referred to the quadratic eight-node shell element (S8) in Figure 68 (just drop the middle nodes).

In CalculiX, S4 and S4R four-node shell elements are expanded into three-dimensional C3D8I and C3D8R elements, respectively. The way this is done can be derived from the analogous treatment of the S8-element in Figure 69 (again, drop the middle nodes). For more information on shell elements the reader is referred to the eight-node shell element S8.

6.2.13 Six-node shell element (S6)

This is a general purpose triangular shell element. The node numbering and the direction of the normal to the surface is shown in Figure 66.

In CalculiX, six-node shell elements are expanded into three-dimensional wedge elements. The way in which this is done is illustrated in Figure 67. For more information on shell elements the reader is referred to the eight-node shell element in the next section.

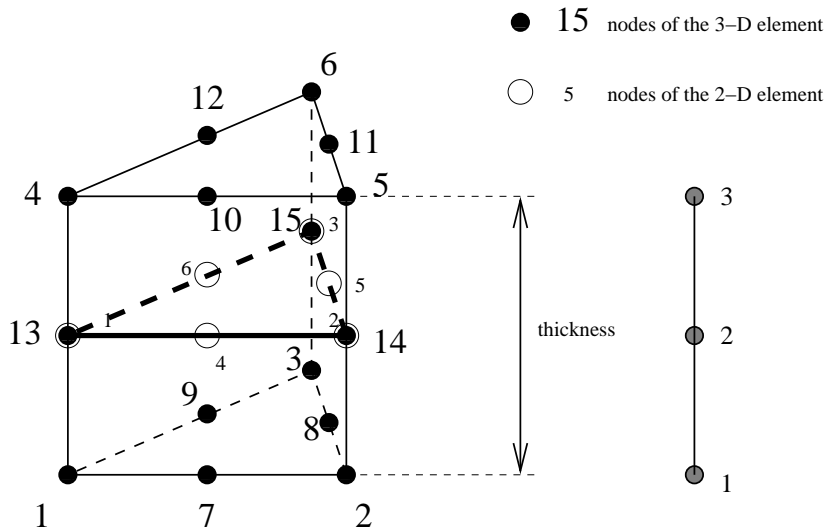

Figure 67: Expansion of a 2D 6-node element into a 3D wedge element

6.2.14 Eight-node shell element (S8 and S8R)

This element is a general purpose 4-sided shell element. The node numbering and the direction of the normal to the surface is shown in Figure 68.

In CalculiX, quadratic shell elements are automatically expanded into 20-node brick elements. The way this is done is illustrated in Figure 69. For each shell node three new nodes are generated according to the scheme on the right of Figure 69. With these nodes a new 20-node brick element is generated: for a S8 element a C3D20 element, for a S8R element a C3D20R element.

Since a shell element can be curved, the normal to the shell surface is defined in each node separately. For this purpose the `*NORMAL` keyword card can be used. If no normal is defined by the user, it will be calculated automatically by CalculiX based on the local geometry.

If a node belongs to more than one shell element, all, some or none of the normals on these elements in the node at stake might have been defined by the user (by means of `*NORMAL`). The failing normals are determined based on the local geometry (notice, however, that for significantly distorted elements it may not be possible to determine the normal; this particularly applies to elements in which the middle nodes are way off the middle position). The number of normals is subsequently reduced using the following procedure. First, the element with the lowest element number with an explicitly defined normal in this set, if any, is taken and used as reference. Its normal is defined as reference normal and the element is stored in a new subset. All other elements of the same type in the set for which the normal has an angle smaller than 0.5° with the reference normal and which have the same local thickness and offset are also included in this subset. The elements in the subset are considered to have the same

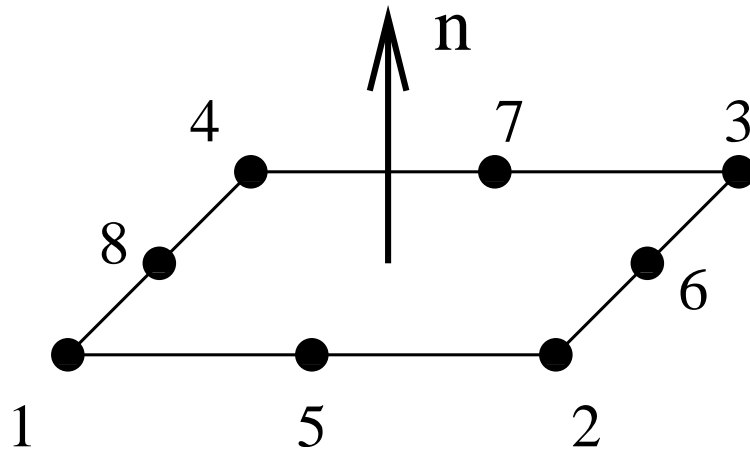

Figure 68: 8-node quadratic element

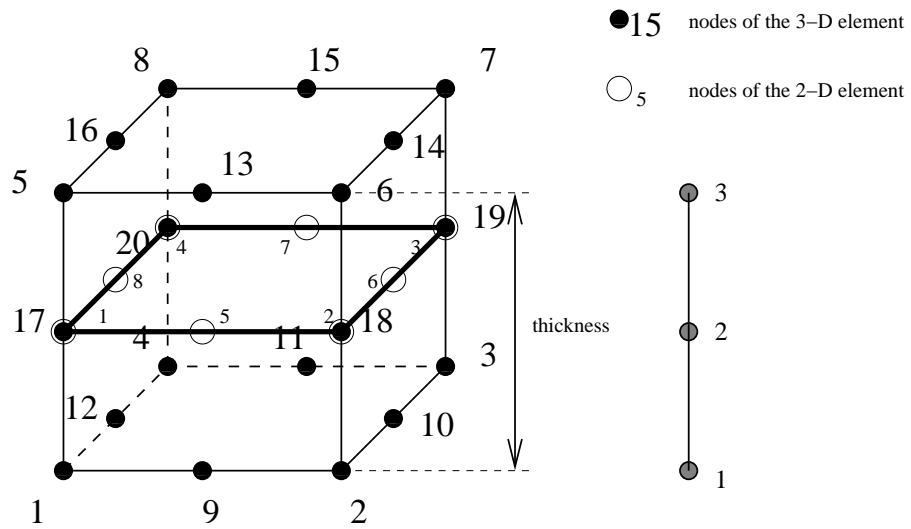

Figure 69: Expansion of a 2D 8-node element into a 3D brick element

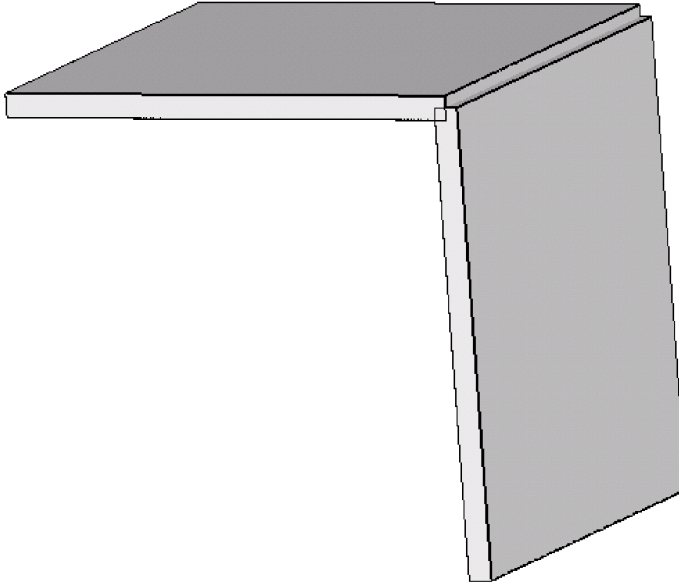

Figure 70: Overlapping shell elements at a knot

normal, which is defined as the normed mean of all normals in the subset. This procedure is repeated for the elements in the set minus the subset until no elements are left with an explicitly defined normal. Now, the element with the lowest element number of all elements left in the set is used as reference. Its normal is defined as reference normal and the element is stored in a new subset. All other elements left in the set for which the normal has an angle smaller than 20° with the reference normal and which have the same local thickness and offset are also included in this subset. The normed mean of all normals in the subset is assigned as new normal to all elements in the subset. This procedure is repeated for the elements left until a normal has been defined in each element.

This procedure leads to one or more normals in one and the same node. If only one normal is defined, this node is expanded once into a set of three new nodes and the resulting three-dimensional expansion is continuous in the node. If more than one normal is defined, the node is expanded as many times as there are normals in the node. To assure that the resulting 3D elements are connected, the newly generated nodes are considered as a knot. A knot is a rigid body which is allowed to expand uniformly. This implies that a knot is characterized by seven degrees of freedom: three translations, three rotations and a uniform expansion. Graphically, the shell elements partially overlap (Figure 70).

Consequently, a node leads to a knot if

- the direction of the local normals in the elements participating in the node differ beyond a given amount. Notice that this also applies to neighboring elements having the inverse normal. Care should be taken that the elements in plates and similar structures are oriented in a consistent way to avoid the generation of knots and the induced nonlinearity.
- several types of elements participate (e.g. shells and beams).
- the thickness is not the same in all participating elements.
- the offset is not the same in all participating elements.
- a rotation or a moment is applied in the node (only for dynamic calculations)

In CalculiX versions prior to and including version 2.7 a knot was also introduced as soon as the user applied a rotation or a moment to a node. Right now, this is still the case for dynamic calculations (cf. listing above). However, in static calculations, starting with version 2.8 this type of loading is handled by using mean rotation MPC's (cf. Section 8.7.1). The mean rotation MPC's are generated automatically, so the user does not have to take care of that. It generally leads to slightly better results than by use of knots. However, the use of mean rotation MPC's prohibits the application of drilling moments, i.e. moments about an axis perpendicular to a shell surface. Similarly, no drilling rotation should be prescribed, unless all rotational degrees of freedom are set to zero in the node. If the shell surface is not aligned along the global coordinate directions, prescribing a moment or rotation about an axis perpendicular to the drilling direction may require the definition of a local coordinate system. Also note that the rotation in a mean rotation MPC should not exceed 90 degrees. Starting with version 2.15 any nonzero drilling moment or rotation is automatically removed and a warning is issued. In earlier versions, a drilling moment or rotation led to an error, forcing the program to abort.

Beam and shell elements are always connected in a stiff way if they share common nodes. This, however, does not apply to plane stress, plane strain and axisymmetric elements. Although any mixture of 1D and 2D elements generates a knot, the knot is modeled as a hinge for any plane stress, plane strain or axisymmetric elements involved in the knot. This is necessary to account for the special nature of these elements (the displacement normal to the symmetry plane and normal to the radial planes is zero for plane elements and axisymmetric elements, respectively).

The translational node of the knot (cfr REF NODE in the *RIGID BODY keyword card) is the knot generating node, the rotational node is extra generated.

The thickness of the shell element can be defined on the *SHELL SECTION keyword card. It applies to the complete element. Alternatively, a nodal thickness in each node separately can be defined using *NODAL THICKNESS. In that way, a shell with variable thickness can be modeled. Thicknesses defined

by a *NODAL THICKNESS card take precedence over thicknesses defined by a *SHELL SECTION card. The thickness always applies in normal direction. The *SHELL SECTION card is also used to assign a material to the shell elements and is therefore indispensable.

The offset of a shell element can be set on the *SHELL SECTION card. Default is zero. The unit of the offset is the local shell thickness. An offset of 0.5 means that the user-defined shell reference surface is in reality the top surface of the expanded element. The offset can take any real value. Consequently, it can be used to define composite materials. Defining three different shell elements using exactly the same nodes but with offsets -1, 0 and 1 (assuming the thickness is the same) leads to a three-layer composite.

However, due to the introduction of a knot in every node of such a composite, the deformation is usually too stiff. Therefore, a different method has been coded to treat composites. Right now, it can only be used for 8-node shells with reduced integration (S8R) and 6-node shell elements (S6). Instead of defining as many shells as there are layers the user only defines one shell element, and uses the option COMPOSITE on the *SHELL SECTION card. Underneath the latter card the user can define as many layers as needed. Internally, the shell element is expanded into only one 3-D brick element but the number of integration points across the thickness amounts to twice the number of layers. During the calculation the integration points are assigned the material properties appropriate for the layer they belong to. In the .dat file the user will find the displacements of the global 3-D element and the stresses in all integration points (provided the user has requested the corresponding output using the *NODE PRINT and *EL PRINT card). In the .frd file, however, each layer is expanded independently and the displacements and stresses are interpolated/extrapolated accordingly (no matter whether the parameter OUTPUT=3D was used). The restrictions on this kind of composite element are right now:

- can only be used for S8R and S6 elements
- reaction forces (RF) cannot be requested in the .frd file.
- the use of *NODAL THICKNESS is not allowed
- the error estimators cannot be used.

In composite materials it is frequently important to be able to define a local element coordinate system. Indeed, composites usually consist of layers of anisotropic materials (e.g. fiber reinforced) exhibiting a different orientation in each layer. To this end the *ORIENTATION card can be used.

First of all, it is of uttermost importance to realize that a shell element ALWAYS induces the creation of a local element coordinate system, no matter whether an orientation card was defined or not. If no orientation applies to a specific layer of a specific shell element then a local shell coordinate system is generated consisting of:

- a local x' -axis defined by the projection of the global x -axis on the shell (actually at the location of the shell which corresponds to local coordinates $\xi = 0, \eta = 0$), or, if the angle between the global x -axis and the normal to the shell is smaller than 0.1° , by the projection of the global z -axis on the shell.
- a local y' -axis such that $y' = z' \times x'$.
- a local z' -axis coinciding with the normal on the shell (defined such that the nodes are defined clockwise in the element topology when looking in the direction of the normal).

Notice that this also applies in shell which are not defined as composites (can be considered as one-layer composites).

If an orientation is applied to a specific layer of a specific shell element then a local shell coordinate system is generated consisting of:

- a local x' -axis defined by the projection of the local x -axis defined by the orientation on the shell (actually at the location of the shell which corresponds to local coordinates $\xi = 0, \eta = 0$), or, if the angle between the local x -axis defined by the orientation and the normal to the shell is smaller than 0.1° , by the projection of the local z -axis as defined by the orientation on the shell.
- a local y' -axis such that $y' = z' \times x'$.
- a local z' -axis coinciding with the normal on the shell (defined such that the nodes are defined clockwise in the element topology when looking in the direction of the normal).

The treatment of the boundary conditions for shell elements is straightforward. The user can independently fix any translational degree of freedom (DOF 1 through 3) or any rotational DOF (DOF 4 through 6). Here, DOF 4 is the rotation about the global or local x -axis, DOF 5 about the global or local y -axis and DOF 6 about the global or local z -axis. Local axes apply if the transformation (*TRANSFORM) has been defined, else the global system applies. A hinge is defined by fixing the translational degrees of freedom only. Recall that it is not allowed to constrain a rotation about the drilling axis on a shell, unless the rotations about all axes in the node are set to zero.

For an internal hinge between 1D or 2D elements the nodes must be doubled and connected with MPC's. The connection between 3D elements and all other elements (1D or 2D) is always hinged.

Point forces defined in a shell node are not modified if a knot is generated (the reference node of the rigid body is the shell node). If no knot is generated, the point load is divided among the expanded nodes according to a 1/2-1/2 ratio for a shell mid-node and a 1/6-2/3-1/6 ratio for a shell end-node. Concentrated bending moments or torques are defined as point loads (*CLOAD) acting on degree four to six in the node. Their use generates a knot in the node.

Distributed loading can be defined by the label P in the *DLOAD card. A positive value corresponds to a pressure load in normal direction.

In addition to a temperature for the reference surface of the shell, a temperature gradient in normal direction can be specified on the *TEMPERATURE card. Default is zero.

Concerning the output, nodal quantities requested by the keyword *NODE PRINT are stored in the shell nodes. They are obtained by averaging the nodal values of the expanded element. For instance, the value in local shell node 1 are obtained by averaging the nodal value of expanded nodes 1 and 5. Similar relationships apply to the other nodes, in 6-node shells:

- shell node 1 = average of expanded nodes 1 and 4
- shell node 2 = average of expanded nodes 2 and 5
- shell node 3 = average of expanded nodes 3 and 6
- shell node 4 = average of expanded nodes 7 and 10
- shell node 5 = average of expanded nodes 8 and 11
- shell node 6 = average of expanded nodes 9 and 12

In 8-node shells:

- shell node 1 = average of expanded nodes 1 and 5
- shell node 2 = average of expanded nodes 2 and 6
- shell node 3 = average of expanded nodes 3 and 7
- shell node 4 = average of expanded nodes 4 and 8
- shell node 5 = average of expanded nodes 9 and 13
- shell node 6 = average of expanded nodes 10 and 14
- shell node 7 = average of expanded nodes 11 and 15
- shell node 8 = average of expanded nodes 12 and 16

Element quantities, requested by *EL PRINT are stored in the integration points of the expanded elements.

Default storage for quantities requested by the *NODE FILE and *EL FILE is in the expanded nodes. This has the advantage that the true three-dimensional results can be viewed in the expanded structure, however, the nodal numbering is different from the shell nodes. By selecting OUTPUT=2D the results are stored in the original shell nodes. The same averaging procedure applies as for the *NODE PRINT command.

In thin structures two words of caution are due: the first is with respect to reduced integration. If the aspect ratio of the beams is very large (slender beams,

aspect ratio of 40 or more) reduced integration will give you far better results than full integration. However, due to the small thickness hourglassing can readily occur, especially if point loads are applied. This results in displacements which are widely wrong, however, the stresses and section forces are correct. Usually also the mean displacements across the section are fine. If not, full integration combined with smaller elements might be necessary. Secondly, thin structures can easily exhibit large strains and/or rotations. Therefore, most calculations require the use of the NLGEOM parameter on the *STEP card.

6.2.15 Three-node membrane element (M3D3)

This element is similar to the S3 shell element except that it cannot sustain bending. This is obtained by modelling hinges in each of the nodes of the element. Apart from that, all what is said about the S3 element also applies here with one exception: instead of the *SHELL SECTION card the *MEMBRANE SECTION card has to be used.

6.2.16 Four-node membrane element (M3D4 and M3D4R)

These elements are similar to the S4 and S4R shell elements, respectively, except that they cannot sustain bending. This is obtained by modelling hinges in each of the nodes of the elements. Apart from that, all what is said about the S4 and S4R elements also applies here with one exception: instead of the *SHELL SECTION card the *MEMBRANE SECTION card has to be used.

6.2.17 Six-node membrane element (M3D6)

This element is similar to the S6 shell element except that it cannot sustain bending. This is obtained by modelling hinges in each of the end nodes of the element. Apart from that, all what is said about the S6 element also applies here with one exception: instead of the *SHELL SECTION card the *MEMBRANE SECTION card has to be used.

6.2.18 Eight-node membrane element (M3D8 and M3D8R)

These elements are similar to the S8 and S8R shell elements, respectively, except that they cannot sustain bending. This is obtained by modelling hinges in each of the end nodes of the elements. Apart from that, all what is said about the S8 and S8R elements also applies here with one exception: instead of the *SHELL SECTION card the *MEMBRANE SECTION card has to be used.

6.2.19 Three-node plane stress element (CPS3)

This element is very similar to the three-node shell element. Figures 66 and 67 apply (just drop the middle nodes). For more information on plane stress elements the reader is referred to the section on CPS8 elements.

6.2.20 Four-node plane stress element (CPS4 and CPS4R)

This element is very similar to the eight-node shell element. Figures 68 and 69 apply (just drop the middle nodes). The CPS4 and CPS4R elements are expanded into C3D8 and C3D8R elements, respectively. For more information on plane stress elements the reader is referred to the section on CPS8 elements.

6.2.21 Six-node plane stress element (CPS6)

This element is very similar to the six-node shell element. Figures 66 and 67 apply. For more information on plane stress elements the reader is referred to the next section.

6.2.22 Eight-node plane stress element (CPS8 and CPS8R)

The eight node plane stress element is a general purpose plane stress element. It is actually a special case of shell element: the structure is assumed to have a symmetry plane parallel to the x-y plane and the loading only acts in-plane. In general, the z-coordinates are zero. Just like in the case of the shell element, the plane stress element is expanded into a C3D20 or C3D20R element. Figures 68 and 69 apply. From the above premises the following conclusions can be drawn:

- The displacement in z-direction of the midplane is zero. This condition is introduced in the form of SPC's. MPC's must not be defined in z-direction!
- The displacements perpendicular to the z-direction of nodes not in the midplane is identical to the displacements of the corresponding nodes in the midplane.
- The normal is by default (0,0,1)
- The thickness can vary. It can be defined in the same way as for the shell element, except that the *SOLID SECTION card is used instead of the *SHELL SECTION card.
- Different offsets do not make sense.
- Point loads are treated in a similar way as for shells.

The use of plane stress elements can also lead to knots, namely, if the thickness varies in a discontinuous way, or if plane stress elements are combined with other 1D or 2D elements such as axisymmetric elements. The connection with the plane stress elements, however, is modeled as a hinge.

Distributed loading in plane stress elements is different from shell distributed loading: for the plane stress element it is in-plane, for the shell element it is out-of-plane. Distributed loading in plane stress elements is defined on the *DLOAD card with the labels P1 up to P4. The number indicates the face as defined in Figure 71.

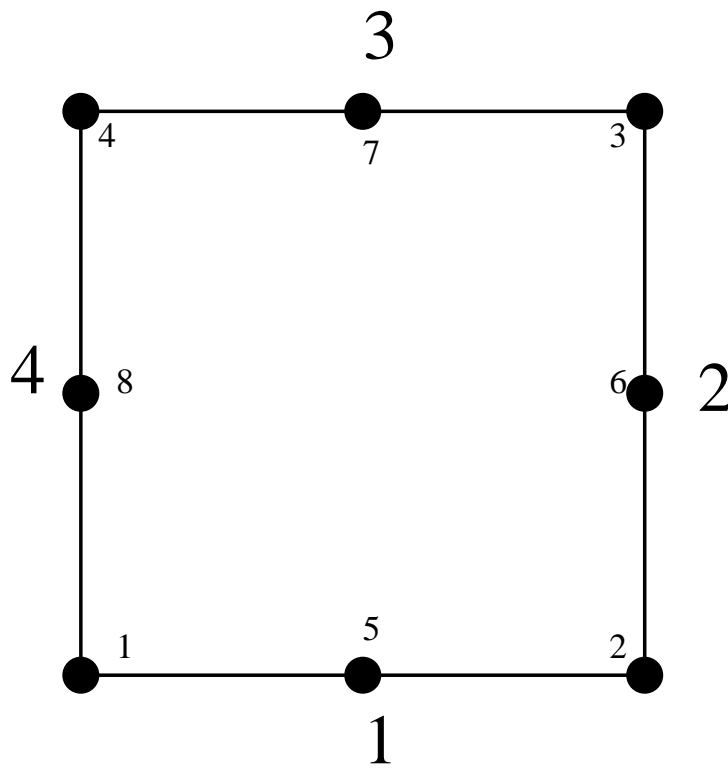

Figure 71: Face numbering for quadrilateral elements

If a plane stress element is connected to a structure consisting of 3D elements the motion of this structure in the out-of-plane direction (z -direction) is not restricted by its connection to the 2D elements. The user has to take care that any rigid body motion of the structure involving the z -direction is taken care of, if appropriate. This particularly applies to any springs connected to plane stress elements, look at test example `spring4` for an illustration.

Notice that structures containing plane stress elements should be defined in the global x - y plane, i.e. $z=0$ for all nodes.

6.2.23 Three-node plane strain element (CPE3)

This element is very similar to the three-node shell element. Figures 66 and 67 apply (just drop the middle nodes). For more information on plane strain elements the reader is referred to the section on CPE8 elements.

6.2.24 Four-node plane strain element (CPE4 and CPE4R)

This element is very similar to the eight-node shell element. Figures 68 and 69 apply (just drop the middle nodes). The CPE4 and CPE4R elements are expanded into C3D8 and C3D8R elements, respectively. For more information on plane strain elements the reader is referred to the section on CPE8 elements.

6.2.25 Six-node plane strain element (CPE6)

This element is very similar to the six-node shell element. Figures 66 and 67 apply. For more information on plane strain elements the reader is referred to the next section.

6.2.26 Eight-node plane strain element (CPE8 and CPE8R)

The eight node plane strain element is a general purpose plane strain element. It is actually a special case of plane stress element: the treatise of Section 6.2.22 also applies here. In addition we have:

- The displacement in z -direction of all nodes (not only the mid-nodes) is zero. This condition is introduced in the form of MPC's, expressing that the displacement in z -direction of nodes not in the midplane is identical to the displacement of the corresponding nodes in the midplane.
- Different thicknesses do not make sense: one thickness applicable to all plane strain elements suffices.

Plane strain elements are used to model a slice of a very long structure, e.g. of a dam.

If a plane strain element is connected to a structure consisting of 3D elements the motion of this structure in the out-of-plane direction (z -direction) is not restricted by its connection to the 2D elements. The user has to take care that any rigid body motion of the structure involving the z -direction is taken care

of, if appropriate. This particularly applies to any springs connected to plane strain elements.

Notice that structures containing plane strain elements should be defined in the global x-y plane, i.e. $z=0$ for all nodes.

6.2.27 Three-node axisymmetric element (CAX3)

This element is very similar to the three-node shell element. Figures 66 and 67 apply (just drop the middle nodes). For more information on axisymmetric elements the reader is referred to the section on CAX8 elements.

6.2.28 Four-node axisymmetric element (CAX4 and CAX4R)

This element is very similar to the eight-node shell element. Figures 68 and 69 apply (just drop the middle nodes). The CAX4 and CAX4R elements are expanded into C3D8 and C3D8R elements, respectively. For more information on axisymmetric elements the reader is referred to the section on CAX8 elements.

6.2.29 Six-node axisymmetric element (CAX6)

This element is very similar to the six-node shell element. Figures 66 and 67 apply. For more information on axisymmetric elements the reader is referred to the next section.

6.2.30 Eight-node axisymmetric element (CAX8 and CAX8R)

This is a general purpose quadratic axisymmetric element. Just as the shell, plane stress and plane strain element it is internally expanded into a C3D20 or C3D20R element according to Figure 69 and the node numbering of Figure 68 applies.

For axisymmetric elements the coordinates of the nodes correspond to the radial direction (first coordinate) and the axial direction (second or y-coordinate). The axisymmetric structure is expanded by rotation about the second coordinate axis, half clockwise and half counterclockwise. The radial direction corresponds to the x-axis in the 3D expansion, the axial direction with the y-axis. The x-y plane cuts the expanded structure in half. The z-axis is perpendicular to the x-y plane such that a right-hand-side axis system is obtained.

The same rules apply as for the plane strain elements, except that in-plane conditions in a plane strain construction now correspond to radial plane conditions in the axisymmetric structure. Expressed in another way, the z-direction in plane strain now corresponds to the circumferential direction in a cylindrical coordinate system with the y-axis as defining axis. Notice that nodes on the x-axis are not automatically fixed in radial direction. The user has to take care of this by using the *BOUNDARY card

Compared to plane strain elements, the following conditions apply:

- The expansion angle is fixed, its size is 2° . The value on the line beneath the *SOLID SECTION keyword, if any, has no effect.
- The displacements in cylindrical coordinates of all nodes not in the defining plane are identical to the displacements of the corresponding nodes in the defining plane. This is formulated using MPC's.
- Forces act in radial planes. They have to be defined for the complete circumference, i.e. if you apply a force in a node, you first have to sum all forces at that location along the circumference and then apply this sum to the node.
- Concentrated heat fluxes act in radial planes. They have to be defined for the complete circumference.
- Mass flow rates act in radial planes. They have to be defined for the complete circumference.
- For distributed loading Figure 71 applies.

A special application is the combination of axisymmetric elements with plane stress elements to model quasi-axisymmetric structures. Consider a circular disk with holes along the circumference, Figure 72. Assume that the holes take up $k\%$ of the circumferential width, i.e. if the center of the holes is located at a radius r , the holes occupy $2\pi rk/100$. Then, the structure is reduced to a two-dimensional model by simulating the holes by plane stress elements with width $2\pi r(100 - k)/100$ and everything else by axisymmetric elements. More sophisticated models can be devised (e.g. taking the volume of the holes into account instead of the width at their center, or adjusting the material properties as well [42]). The point here is that due to the expansion into three-dimensional elements a couple of extra guidelines have to be followed:

- expanded plane stress and axisymmetric elements must have a small thickness to yield good results: in the case of plane stress elements this is because a large thickness does not agree with the plane stress assumption, in the case of axisymmetric elements because large angles yield bad results since the expansion creates only one layer of elements. CalculiX uses an expansion angle of 2° , which amounts to $\pi/90$ radians. Consequently, only $100/180\%$ of the disk is modeled and the thickness of the plane stress elements is $(100 - k)\pi r/9000$. This is done automatically within CalculiX. On the *SOLID SECTION card the user must specify the thickness of the plane stress elements for 360° , i.e. $2\pi r(100 - k)/100$.
- the point forces on the axisymmetric elements are to be given for the complete circumference, as usual for axisymmetric elements.
- the point forces on the plane stress elements act on the complete circumference.

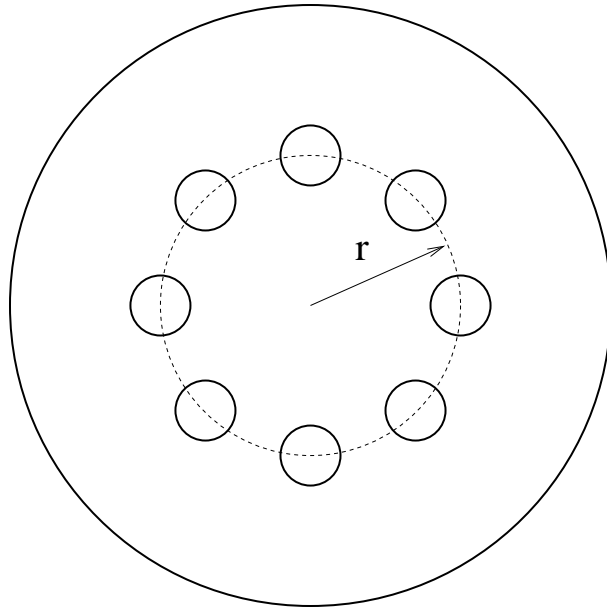

Figure 72: Disk with holes

- distributed loads are not affected, since they act on areas and/or volumes.

If an axisymmetric element is connected to a structure consisting of 3D elements the motion of this structure in the circumferential direction is not restricted by its connection to the 2D elements. The user has to take care that any rigid body motion of the structure involving the circumferential direction is taken care of, if appropriate. This particularly applies to any springs connected to axisymmetric elements.

Notice that structures containing axisymmetric elements should be defined in the global x-y plane, i.e. $z=0$ for all nodes.

6.2.31 Two-node 2D beam element (B21)

This element is internally replaced by a B31 element and is treated as such.

6.2.32 Two-node 3D beam element (B31 and B31R)

This element is very similar to the three-node beam element. Figures 73 and 74 apply (just drop the middle nodes). The B31 and B31R elements are expanded into C3D8I and C3D8R elements, respectively. Since the C3D8R element has only one integration point in the middle of the element, bending effect cannot be taken into account. Therefore, the B31R element should not be used for bending. For more information on beam elements the reader is referred to the next section.

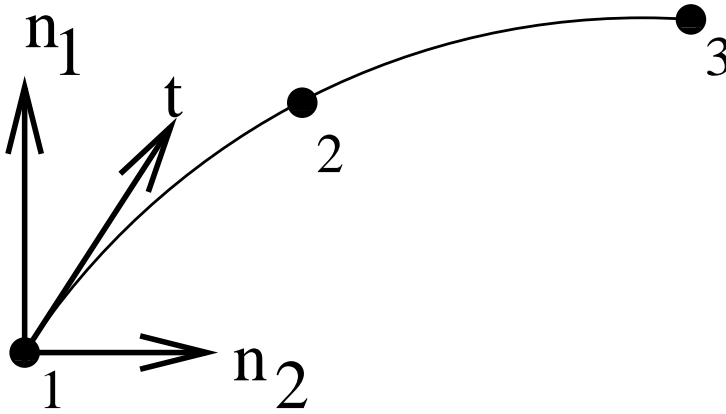

Figure 73: 3-node quadratic beam element/3-node network element

6.2.33 Three-node 3D beam element (B32 and B32R)

In CalculiX this is the general purpose beam element. The node numbering is shown in Figure 73.

In each node a local Cartesian system $\mathbf{t} - \mathbf{n}_1 - \mathbf{n}_2$ is defined. \mathbf{t} is the normalized local tangential vector, \mathbf{n}_1 is a normalized vector in the local 1-direction and \mathbf{n}_2 is a normalized vector in the local 2-direction, also called the normal. The local directions 1 and 2 are used to expand the beam element into a C3D20 or C3D20R element according to Figure 74.

For each node of the beam element 8 new nodes are generated according to the scheme on the right of Figure 74. These new nodes are used in the definition of the brick element, and their position is defined by the local directions together with the thickness and offset in these directions.

The tangential direction follows from the geometry of the beam element. The normal direction (2-direction) can be defined in two ways:

- either by defining the normal explicitly by using the *NORMAL keyword card.
- if the normal is not defined by the *NORMAL card, it is defined implicitly by $\mathbf{n}_2 = \mathbf{t} \times \mathbf{n}_1$

In the latter case, \mathbf{n}_1 can be defined either

- explicitly on the *BEAM SECTION card.
- implicitly through the default of (0,0,-1).

If a node belongs to more than one beam element, the tangent and the normal is first calculated for all elements to which the node belongs. Then, the element with the lowest element number in this set for which the normal was defined

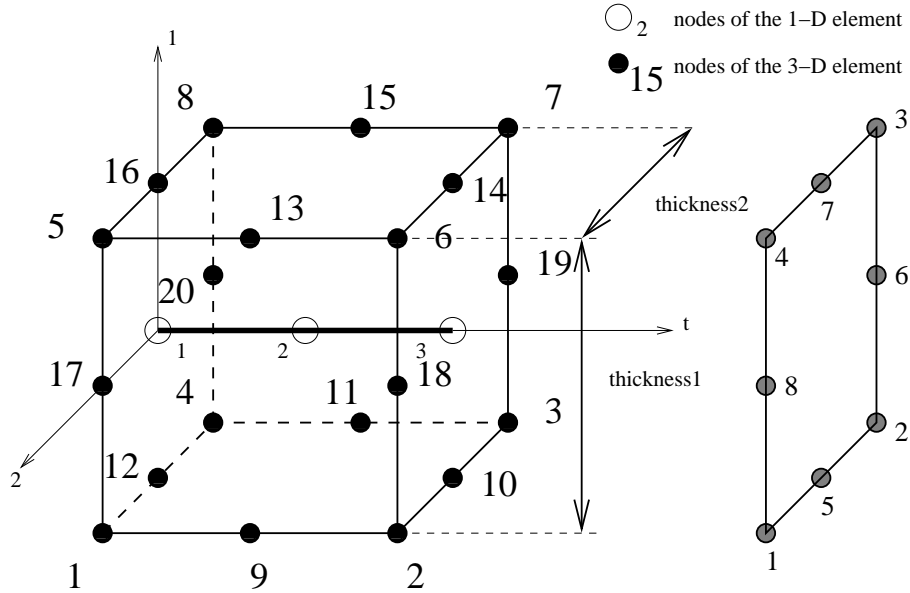

Figure 74: Expansion of a beam element

explicitly using a *NORMAL card is used as reference. Its normal and tangent are defined as reference normal and reference tangent and the element is stored in a new subset. All other elements of the same type in the set for which the normal and tangent have an angle smaller than 0.5° with the reference normal and tangent and which have the same local thicknesses, offsets and sections are also included in this subset. All elements in the subset are considered to have the same normal and tangent. The normal is defined as the normed mean of all normals in the subset, the same applies to the tangent. Finally, the normal is slightly modified within the tangent-normal plane such that it is normal to the tangent. This procedure is repeated until no elements are left with an explicitly defined normal. Then, the element with the lowest element number left in the set is used as reference. Its normal and tangent are defined as reference normal and reference tangent and the element is stored in a new subset. All other elements of the same type in the set for which the normal and tangent have an angle smaller than 20° with the reference normal and tangent and which have the same local thicknesses, offsets and sections are also included in this subset. All elements in the subset are considered to have the same normal and tangent. This normal is defined as the normed mean of all normals in the subset, the same applies to the tangent. Finally, the normal is slightly modified within the tangent-normal plane such that it is normal to the tangent. This procedure is repeated until a normal and tangent have been defined in each element. Finally, the 1-direction is defined by $\mathbf{n}_1 = \mathbf{n}_2 \times \mathbf{t}$.

If this procedure leads to more than one local coordinate system in one and

the same node, all expanded nodes are considered to behave as a knot with the generating node as reference node. Graphically, the beam elements partially overlap (Figure 75).

Consequently, a node leads to a knot if

- the direction of the local normals in the elements participating in the node differ beyond a given amount. Notice that this also applies to neighboring elements having the inverse normal. Care should be taken that the elements in beams are oriented in a consistent way to avoid the generation of knots.
- several types of elements participate (e.g. shells and beams).
- the thickness is not the same in all participating elements.
- the offset is not the same in all participating elements.
- the section is not the same in all participating elements.
- a rotation or a moment is applied in the node (only for dynamic calculations)

Similarly to shells applied rotations or moments (bending moments, torques) in static calculations are taken care of by the automatic generation of mean rotation MPC's.

Beam and shell elements are always connected in a stiff way if they share common nodes. This, however, does not apply to plane stress, plane strain and axisymmetric elements. Although any mixture of 1D and 2D elements generates a knot, the knot is modeled as a hinge for any plane stress, plane strain or axisymmetric elements involved in the knot. This is necessary to account for the special nature of these elements (the displacement normal to the symmetry plane and normal to the radial planes is zero for plane elements and axisymmetric elements, respectively).

The section of the beam must be specified on the `*BEAM SECTION` keyword card. It can be rectangular (`SECTION=RECT`), elliptical (`SECTION=CIRC`), pipe-like (`SECTION=PIPE`) or box-like (`SECTION=BOX`). A circular cross section is a special case of elliptical section, pipe and box sections are special cases of a rectangular cross section obtained through appropriate integration point schemes. For a rectangular cross section the local axes must be defined parallel to the sides of the section, for an elliptical section they are parallel to the minor and major axes of the section. The thickness of a section is the distance between the free surfaces, i.e. for a circular section it is the diameter.

The thicknesses of the beam element (in 1- and 2-direction) can be defined on the `*BEAM SECTION` keyword card. It applies to the complete element. Alternatively, the nodal thicknesses can be defined in each node separately using `*NODAL THICKNESS`. That way, a beam with variable thickness can be modeled. Thicknesses defined by a `*NODAL THICKNESS` card take precedence over thicknesses defined by a `*BEAM SECTION` card.

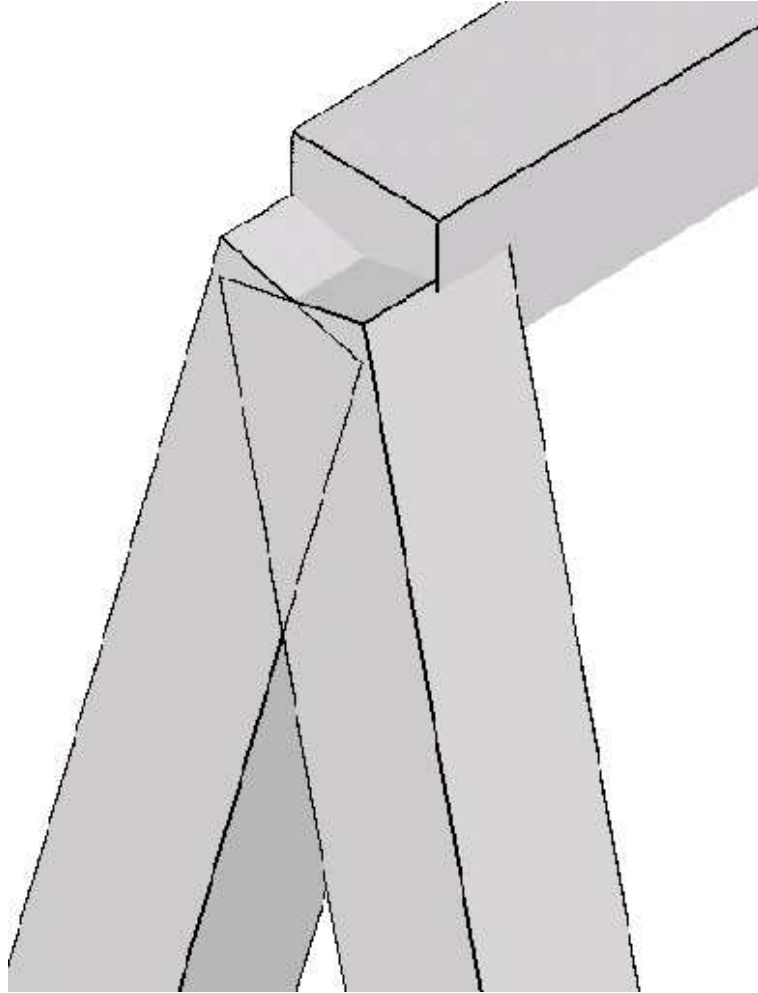

Figure 75: Overlapping beam elements at a knot

The offsets of a beam element (in 1- and 2-direction) can be set on the *BEAM SECTION card. Default is zero. The unit of the offset is the beam thickness in the appropriate direction. An offset of 0.5 means that the user-defined beam reference line lies in reality on the positive surface of the expanded beam (i.e. the surface with an external normal in direction of the local axis). The offset can take any real value. Consequently, it can be used to define composite structures, such as a plate supported by a beam, or a I cross section built up of rectangular cross sections.

The treatment of the boundary conditions for beam elements is straightforward. The user can independently fix any translational degree of freedom (DOF 1 through 3) or any rotational DOF (DOF 4 through 6). Here, DOF 4 is the rotation about the global x-axis, DOF 5 about the global y-axis and DOF 6 about the global z-axis. No local coordinate system should be defined in nodes with constrained rotational degrees of freedom. A hinge is defined by fixing the translational degrees of freedom only.

For an internal hinge between 1D or 2D elements the nodes must be doubled and connected with MPC's. The connection between 3D elements and all other elements (1D or 2D) is always hinged.

Point forces defined in a beam node are not modified if a knot is generated (the reference node is the beam node). If no knot is generated, the point load is divided among the expanded nodes according to a $1/4-1/4-1/4-1/4$ ratio for a beam mid-node and a $(-1/12)-(1/3)-(-1/12)-(1/3)-(-1/12)-(1/3)-(-1/12)-(1/3)$ ratio for a beam end-node. Concentrated bending moments or torques are defined as point loads (*CLOAD) acting on degree four to six in the node. Their use generates a knot in the node.

Distributed loading can be defined by the labels P1 and P2 in the *DLOAD card. A positive value corresponds to a pressure load in direction 1 and 2, respectively.

In addition to a temperature for the reference surface of the beam, a temperature gradient in 1-direction and in 2-direction can be specified on the *TEMPERATURE. Default is zero.

Concerning the output, nodal quantities requested by the keyword *NODE PRINT are stored in the beam nodes. They are obtained by averaging the nodal values of the expanded element. For instance, the value in local beam node 1 are obtained by averaging the nodal value of expanded nodes 1, 4, 5 and 8. Similar relationships apply to the other nodes:

- beam node 1 = average of expanded nodes 1,4,5 and 8
- beam node 2 = average of expanded nodes 9,11,13 and 15
- beam node 3 = average of expanded nodes 2,3,6 and 7

Element quantities, requested by *EL PRINT are stored in the integration points of the expanded elements.

Default storage for quantities requested by the *NODE FILE and *EL FILE is in the expanded nodes. This has the advantage that the true three-dimensional

results can be viewed in the expanded structure, however, the nodal numbering is different from the beam nodes. By using the OUTPUT=2D parameter in the first step one can trigger the storage in the original beam nodes. The same averaging procedure applies as for the *NODE PRINT command. Section forces can be requested by means of the parameter SECTION FORCES. If selected, the stresses in the beam nodes are replaced by the section forces. They are calculated in a local coordinate system consisting of the 1-direction \mathbf{n}_1 , the 2-direction \mathbf{n}_2 and 3-direction or tangential direction \mathbf{t} (Figure 74). Accordingly, the stress components now have the following meaning:

- xx: Shear force in 1-direction
- yy: Shear force in 2-direction
- zz: Normal force
- xy: Torque
- xz: Bending moment about the 2-direction
- yz: Bending moment about the 1-direction

The section forces are calculated by a numerical integration of the stresses over the cross section. To this end the stress tensor is needed at the integration points of the cross section. It is determined from the stress tensors at the nodes belonging to the cross section by use of the shape functions. Therefore, if the section forces look wrong, look at the stresses in the expanded beams (omitting the SECTION FORCES and OUTPUT=2D parameter).

For all elements different from beam elements the parameter SECTION FORCES has no effect.

In thin structures two words of caution are due: the first is with respect to reduced integration. If the aspect ratio of the shells is very large (slender shells) reduced integration will give you far better results than full integration. In order to avoid hourglassing a 2x5x5 Gauss-Kronrod integration scheme is used for B32R-elements with a rectangular cross section. This scheme contains the classical Gauss scheme with reduced integration as a subset. The integration point numbering is shown in Figure 76. For circular cross sections the regular reduced Gauss scheme is used. In the rare cases that hourglassing occurs the user might want to use full integration with smaller elements. Secondly, thin structures can easily exhibit large strains and/or rotations. Therefore, most calculations require the use of the NLGEOM parameter on the *STEP card.

6.2.34 Two-node 2D truss element (T2D2)

This element is internally replaced by a T3D2 element and is treated as such.

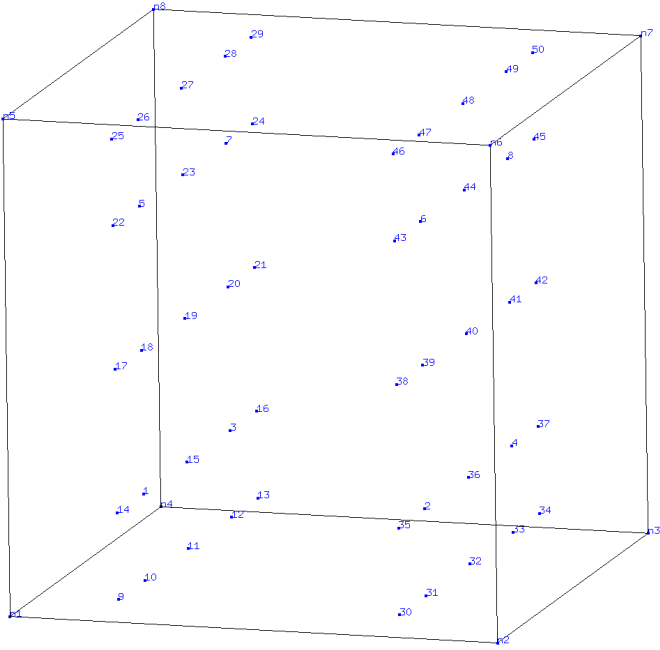

Figure 76: Gauss-Kronrod integration scheme for B32R elements with rectangular cross section

6.2.35 Two-node 3D truss element (T3D2)

This element is similar to the B31 beam element except that it cannot sustain bending. This is obtained by inserting hinges in each node of the element. Apart from this all what is said about the B31 element also applies to the T3D2 element with one exception: instead of the *BEAM SECTION card the *SOLID SECTION card has to be used.

6.2.36 Three-node 3D truss element (T3D3)

This element is similar to the B32 beam element except that it cannot sustain bending. This is obtained by inserting hinges in each end node of the element. Apart from this all what is said about the B32 element also applies to the T3D3 element with one exception: instead of the *BEAM SECTION card the *SOLID SECTION card has to be used.

6.2.37 Three-node network element (D)

This is a general purpose network element used in forced convection applications. It consists of three nodes: two corner nodes and one midside node. The node numbering is shown in Figure 73. In the corner nodes the only active degrees of freedom are the temperature degree of freedom (degree of freedom 11) and the pressure degree of freedom (degree of freedom 2). These nodes can be used in forced convection *FILM conditions. In the middle node the only active degree of freedom is degree of freedom 1, and stands for the mass flow rate through the element. A positive mass flow rate flows from local node 1 to local node 3, a negative mass flow rate in the reverse direction. It can be defined using a *BOUNDARY card for the first degree of freedom of the midside node of the element. Fluid material properties can be defined using the *MATERIAL, *FLUID CONSTANTS and *SPECIFIC GAS CONSTANT cards and assigned by the *FLUID SECTION card.

network elements form fluid dynamic networks and should not share any node with any other type of element. Basically, analyses involving fluid dynamic networks belong to one of the following two types of calculations:

- Pure thermomechanical calculations. In that case the mass flow in all elements of the network is known and the only unknowns are the temperature (in the network and the structure) and displacements (in the structure). This mode is automatically activated if all mass flows are specified using boundary cards. In that case, pressures in the network are NOT calculated. Furthermore, the type of network element is not relevant and should not be specified.
- Fully coupled calculations involving fluid thermodynamical calculations with structural thermomechanical calculations. This mode is triggered if the mass flow in at least one of the network elements is not known. It requires for each network element the specification of its fluid section type.

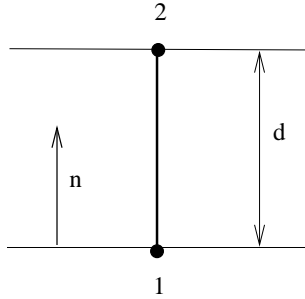

Figure 77: Definition of a GAPUNI element

The available types of fluid sections are listed in subsection 6.4 and 6.5.

Notice that three-node network elements are one-dimensional and can account for two- or three-dimensional effects in the fluid flow only to a limited degree.

A special kind of network element is one in which one of the corner nodes is zero (also called a dummy network element). This type of element is used at those locations where mass flow enters or leaves the network. In this case the corner node which is not connected to any other network element gets the label zero. This node has no degrees of freedom. The degree of freedom 1 of the midside node corresponds to the entering or leaving mass flow.

6.2.38 Two-node unidirectional gap element (GAPUNI)

This is a standard gap element defined between two nodes. The clearance d of the gap and its direction \mathbf{n} are defined by using the *GAP card. Let the displacement vector of the first node of the GAPUNI element be \mathbf{u}_1 and the displacement vector of the second node \mathbf{u}_2 . Then, the gap condition is defined by (Figure 77):

$$d + \mathbf{n} \cdot (\mathbf{u}_2 - \mathbf{u}_1) \geq 0. \quad (21)$$

6.2.39 Two-node 3-dimensional dashpot (DASHPOTA)

The dashpot element is defined between two nodes (Figure 78). The force in node 2 amounts to:

$$\mathbf{F}_2 = -c \left[(\mathbf{v}_2 - \mathbf{v}_1) \cdot \frac{(\mathbf{x}_2 - \mathbf{x}_1)}{L} \right] \frac{(\mathbf{x}_2 - \mathbf{x}_1)}{L} \quad (22)$$

where c is the dashpot coefficient, \mathbf{v} is the velocity vector, \mathbf{x} is the actual location of the nodes and L is the actual distance between them. Notice that

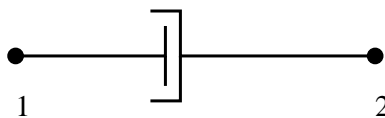

Figure 78: Definition of a DASHPOTA element

$\mathbf{F}_1 = -\mathbf{F}_2$. Right now, only linear dashpots are allowed, i.e. the dashpot coefficient is constant (i.e. it does not depend on the relative velocity. However, it can depend on the temperature). It is defined using the *DASHPOT keyword card.

The two-node three-dimensional dashpot element is considered as a genuine three-dimensional element. Consequently, if it is connected to a 2D element with special restraints on the third direction (plane stress, plane strain or axisymmetric elements) the user has to take care that the third dimension does not induce rigid body motions in the dashpot nodes.

The dashpot element can only be used in linear dynamic calculations characterized by the *MODAL DYNAMIC keyword card.

6.2.40 One-node 3-dimensional spring (SPRING1)

This is a spring element which is attached to only one node. The direction \mathbf{n} in which the spring acts has to be defined by the user underneath the *SPRING keyword card by specifying the appropriate degree of freedom. This degree of freedom can be local if the ORIENTATION parameter is used on the *SPRING card. If \mathbf{u} is the displacement in the spring node and K is the spring constant, the force is obtained by:

$$\mathbf{F} = K(\mathbf{u} \cdot \mathbf{n})\mathbf{n}. \quad (23)$$

A nonlinear spring can be defined by specifying a piecewise linear force versus elongation relationship (underneath the *SPRING card).

6.2.41 Two-node 3-dimensional spring (SPRING2)

This is a spring element which is attached to two nodes (Figure 79). The directions \mathbf{n}_1 and \mathbf{n}_2 determining the action of the spring have to be defined by the user underneath the *SPRING keyword card by specifying the appropriate degrees of freedom. These degrees of freedom can be local if the ORIENTATION parameter is used on the *SPRING card. Usually, it does not make sense to take a different degree of freedom in node 1 and node 2. If \mathbf{u}_1 is the displacement in node 1 (and similar for node 2) and K is the spring constant, the force in node 1 is obtained by:

$$\mathbf{F}_1 = K[(\mathbf{u}_1 \cdot \mathbf{n}_1)\mathbf{n}_1 - (\mathbf{u}_2 \cdot \mathbf{n}_2)\mathbf{n}_1], \quad (24)$$

and the force in node 2 by:



Figure 79: Definition of a SPRINGA element

$$\mathbf{F}_2 = -K[(\mathbf{u}_1 \cdot \mathbf{n}_1)\mathbf{n}_2 - (\mathbf{u}_2 \cdot \mathbf{n}_2)\mathbf{n}_2]. \quad (25)$$

A nonlinear spring can be defined by specifying a piecewise linear force versus elongation relationship (underneath the *SPRING card).

6.2.42 Two-node 3-dimensional spring (SPRINGA)

This is a spring element defined between two nodes (Figure 79). The force needed in node 2 to extend the spring with original length L_0 to a final length L is given by:

$$\mathbf{F} = k(L - L_0)\mathbf{n}, \quad (26)$$

where k is the spring stiffness and \mathbf{n} is a unit vector pointing from node 1 to node 2. The force in node 1 is $-\mathbf{F}$. This formula applies if the spring stiffness is constant. It is defined using the *SPRING keyword card. Alternatively, a nonlinear spring can be defined by providing a graph of the force versus the elongation. In calculations in which NLGEOM is active (nonlinear geometric calculations) the motion of nodes 1 and 2 induces a change of \mathbf{n} .

The two-node three-dimensional spring element is considered as a genuine three-dimensional element. Consequently, if it is connected to a 2D element with special restraints on the third direction (plane stress, plane strain or axisymmetric elements) the user has to take care that the third dimension does not induce rigid body motions in the spring nodes. An example of how to restrain the spring is given in test example spring4.

Note that a spring under compression, if not properly restrained, may change its direction by 180° , leading to unexpected results. Furthermore, for nonlinear springs, it does not make sense to extend the force-elongation curve to negative elongation values $\leq L_0$.

6.2.43 One-node coupling element (DCOUP3D)

This type of element is used to define the reference node of a distributing coupling constraint (cf. *DISTRIBUTING COUPLING). The node should not belong to any other element. The coordinates of this node are immaterial.

6.2.44 One-node mass element (MASS)

This element is used to define nodal masses. The topology description consists of the one node in which the mass is applied. The size of the mass is defined using the *MASS card.

6.2.45 User Element (Uxxxx)

The user can define his/her own elements. In order to do so he/she has to:

- Give a name to the element. The name has to start with “U” followed by maximal 4 characters. Any character from the ASCII character set can be taken, but please note that lower case characters are converted into upper case by CalculiX. Consequently, “Ubeam” and “UBEam” are the same name. This reduces the character set from 256 to 230 characters.
- specify the number of integration points within the element (maximum 256), the number of nodes belonging to the element (maximum 256) and the number of degrees of freedom in each node (maximum 256) by using the *USER ELEMENT keyword card.
- write a FORTRAN subroutine resultsmech_uxxxx.f calculating the secondary variables (usually strains, stresses, internal forces) from the primary variables (= the solution of the equation system, usually displacements, rotations....). Add a call to this routine in resultsmech.u.f
- write a FORTRAN subroutine e_c3d_uxxxx.f calculating the element stiffness matrix and the element external force vector (and possibly the element mass matrix). Add a call to this routine in e_c3d.u.f
- write a FORTRAN subroutine extrapolate_uxxxx.f calculating the value of the secondary variables (usually strains, stresses..) at the nodes based on their values at the integration points within the element. Add a call to this routine in extrapolate.u.f

6.2.46 User Element: 3D Timoshenko beam element (U1)

An example for a 3D Timoshenko beam element (for static linear elastic calculations and small deformations) according to [106] is implemented as element “U1” in CalculiX. It is used in example userbeam.inp in the test suite. The reader is referred to files resultsmech_u1.f, e_c3d_u1.f and extrapolate_u1.f for details on how a user elements is coded.

6.2.47 User Element: 3-node shell element (US3)

The US3 shell element has six degrees of freedom per node - three translations and three rotations (Figure 80). The discrete shear gap approach together with the cell smoothing technique is implemented for the treatment of shear locking. The membrane behavior is resolved by means of the assumed natural deviatoric

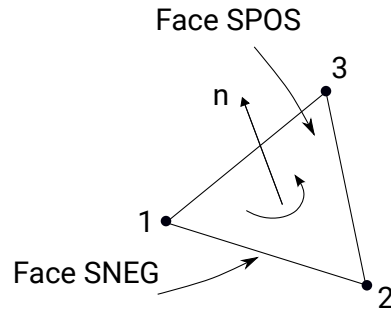

Figure 80: Definition of the US3 element

strains formulation with certain adjustments implemented to accommodate for shell behavior. A detailed description of the formulation is given in [78]. In that reference the accuracy and convergence rate were tested on a chosen set of well-known challenging benchmark problems, and the results were compared with those yielded by the Abaqus© S3 element. The element shows a very good performance in the static linear elastic analysis compared to the Abaqus© S3 element.

The shell formulation is implemented as element US3 in CalculiX and can be used for static and dynamic linear elastic (small deformations) calculations under the consideration of isotropic material properties. Simpson's rule (three points) is provided to calculate the cross-sectional behavior of the shell. For a homogeneous section this integration scheme is exact for linear problems and should be sufficient for routine thermal-stress calculations. Following loadings are implemented:

- Concentrated forces and moments.
- Nodal temperatures with temperature gradients through shell thickness.
- Element face pressure loads.

6.2.48 Substructure (Superelement)

A substructure (also called superelement in some coded) is an element characterized by a number of nodes and a stiffness (and optionally a mass matrix) describing the relationship between forces and displacements in these nodes. The matrices may have been obtained by another code. The element definition is triggered by a *MATRIX ASSEMBLE card (instead of an *ELEMENT card), the name of the file containing the stiffness matrix and, optionally, the name of the file containing the mass matrix. Right now, both have to be symmetric and only the upper triangle (including the diagonal) or the lower triangle (including the diagonal) should be given in the form

```
row node, row dof, column node, column dof, value
```

for each entry of the matrix, one per line (the order is irrelevant). A substructure can right now contain at most 256 nodes and only translational degrees of freedom (=dof) are allowed (dof 1 for the global x-axis, dof 2 for the global y-axis and dof 3 for the global z-axis). In addition, the matrix should receive a name containing at most 4 characters. Names of existing user elements excluding the “U” in front should not be used, such as “S3”. The nodes belonging to the element may be subject to Single Point Constraints, Multiple Point Constraints or point loads, but not to distributed loading (neither facial nor volumetric). Since the location of any integration points is not known, no element values such as stresses or strains are calculated. Only nodal information can be stored to file using *NODE PRINT and similar keyword cards.

A substructure is basically a linear construct. Right now, it can be used in a *STATIC, *DYNAMIC or *FREQUENCY procedure.

6.3 Beam Section Types

A beam element is characterized by its cross section. This cross section is defined by a *BEAM SECTION card. All beam sections which are not rectangular (including square) or elliptical (including circular) are considered as “beam general sections” and are internally expanded into a rectangular cross section (C3D20R-type element) and the actual section of the beam is simulated by an appropriate integration point scheme. A section type is characterized by a finite number of parameters, which must be entered immediately underneath the *BEAM SECTION card. A new section type can be added by changing the following routines:

- allocation.f (define the new section underneath the *BEAMSECTION if-statement)
- calinput.f (define the new section underneath the *BEAMSECTION if-statement)
- beamgeneralsections.f (here, the one-letter abbreviation for the section has to be added. For instance, the pipe section is characterized by ‘P’. Furthermore, the programmer must define the number of parameters needed to characterize the section).
- beamintscheme.f (here, the integration point scheme has to be defined)
- beamextscheme.f (here, the extrapolation of the integration point variables such as stresses or strains to the nodes of the expanded C3D20R element).

Right now, the following section types are available:

6.3.1 Pipe

The pipe section is circular and is characterized by its outer radius and its thickness (in that order). There are 8 integration points equally distributed

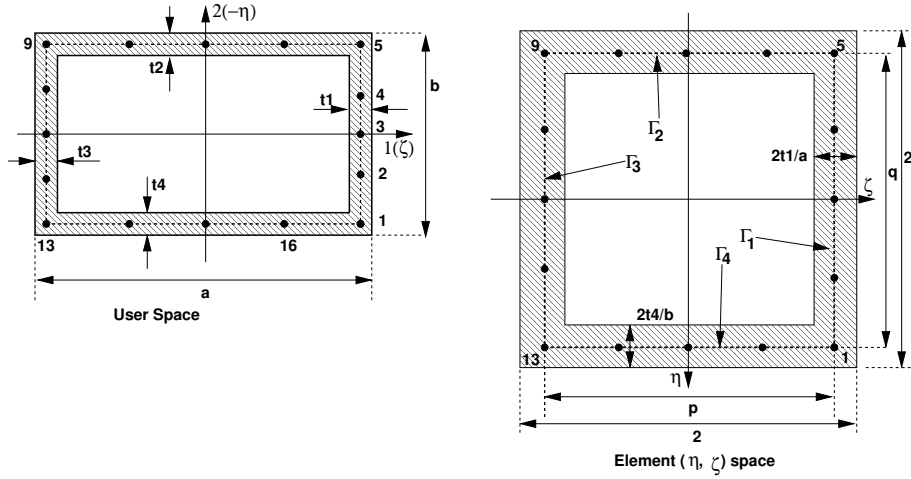

Figure 81: Geometry of the box

along the circumference. In local coordinates, the radius at which the integration points are located is $\sqrt{(\xi^2 + 1)/2}$, where $\xi = r/R$, r being the inner radius and R the outer radius. The weight for each integration point is given by $\pi*(1-\xi^2)/8$ [12].

6.3.2 Box

The Box section (contributed by O. Bernhardt) is simulated using a 'parent' beam element of type B32R.

The outer cross sections are defined by a and b , the wall thicknesses are t_1 , t_2 , t_3 and t_4 and are to be given by the user (Figure 81).

The cross-section integration is done using Simpson's method with 5 integration points for each of the four wall segments. Line integration is performed; therefore, the stress gradient through an individual wall is neglected. Each wall segment can be assigned its own wall thickness.

The integration in the beam's longitudinal direction ξ is done using the usual Gauss integration method with two stations; therefore, the element has a total of 32 integration points.

From the figure, we define, for example, the local coordinates of the first integration point

$$\xi_1 = -\frac{1}{\sqrt{3}}; \quad \eta_1 = 1 - \frac{t_4}{b}; \quad \zeta_1 = 1 - \frac{t_1}{a} \quad (27)$$

The other three corner points are defined correspondingly. The remaining points are evenly distributed along the center lines of the wall segments. The length p and q of the line segments, as given w.r.t. the element intrinsic coordinates η and ζ , can now be calculated as

$$p = 2 - \frac{t_1}{a} - \frac{t_3}{a}; \quad q = 2 - \frac{t_2}{b} - \frac{t_4}{b}; \quad (28)$$

An integral of a function $f(\eta, \zeta)$, over the area Ω of the hollow cross section and evaluated w.r.t the natural coordinates η, ζ , can be approximated by four line integrals, as long as the line segments $\Gamma_1, \Gamma_2, \Gamma_3$ and Γ_4 are narrow enough:

$$\begin{aligned} \int_{\Omega} f(\eta, \zeta) d\Omega &\approx \\ \frac{2t_1}{a} \int f(\eta(\Gamma_1), \zeta) d\Gamma_1 &+ \frac{2t_2}{b} \int f(\eta, \zeta(\Gamma_2)) d\Gamma_2 + \\ \frac{2t_3}{a} \int f(\eta(\Gamma_3), \zeta) d\Gamma_3 &+ \frac{2t_4}{b} \int f(\eta, \zeta(\Gamma_4)) d\Gamma_4 \end{aligned} \quad (29)$$

According to Simpson's rule, the integration points are spaced evenly along each segment. For the integration weights we get, for example, in case of the first wall segment

$$w_k = \{1, 4, 2, 4, 1\} \frac{q}{12} \quad (30)$$

Therefore, we get, for example, for corner Point 1

$$w_1 = \frac{1}{6} \frac{t_1}{a} q + \frac{1}{6} \frac{t_4}{b} p \quad (31)$$

and for Point 2

$$w_2 = \frac{4}{6} \frac{t_1}{a} q \quad (32)$$

The resulting element data (stresses and strains) are extrapolated from the eight corner integration points (points 1,5,9 and 13) from the two Gauss integration stations using the shape functions of the linear 8-node hexahedral element.

Remarks

- The wall thickness are assumed to be small compared to the outer cross section dimensions.
- The bending stiffnesses of the individual wall segments about their own neutral axes are completely neglected due to the line integral approach.
- Torsion stiffness is governed to a large extent by warping of the cross section which in turn can only be modelled to a limited extent by this type of element.
- Modelling of U or C profiles is also possible by setting one of the wall thicknesses to zero. Modelling L sections however, by setting the wall thickness of two segments to zero, will probably cause spurious modes.

6.3.3 General

The general section can only be used for user element type U1 and is defined by the following properties (to be given by the user in that order):

- cross section area A
- moment of inertia I_{11}
- moment of inertia I_{12}
- moment of inertia I_{22}
- Timoshenko shear coefficient k

Furthermore, the specification of the 1-direction (cf. third line in the *BEAM SECTION definition) is REQUIRED for this type of section. Internally, the properties are stored in the prop-array in the following order:

- cross section area A
- moment of inertia I_{11}
- moment of inertia I_{12}
- moment of inertia I_{22}
- Timoshenko shear coefficient k
- global x-coordinate of a unit vector in 1-direction
- global y-coordinate of a unit vector in 1-direction
- global z-coordinate of a unit vector in 1-direction
- offset1
- offset2

In the present implementation of the U1-type element I_{12} , offset1 and offset2 have to be zero.

6.4 Fluid Section Types: Gases

Before introducing the fluid section types for gases, a couple of fundamental aerodynamic equations are introduced. For details, the reader is referred to [67]. The thermodynamic state of a gas is usually determined by the static pressure p , the static temperature T and the density ρ . For an ideal gas (the case considered here), they are related by $p = \rho r T$ (the ideal gas equation), where r is the specific gas constant. r only depends on the material, it does not depend on the temperature.

The energy conservation law runs like [23]:

$$\rho \frac{D\varepsilon}{Dt} = v_{k,l}t_{kl} - pv_{k,k} - q_{k,k} + \rho h^\theta, \quad (33)$$

where D denotes the total derivative. By use of the mass conservation:

$$\frac{\partial \rho}{\partial t} + (\rho v_k)_{,k} = 0 \quad (34)$$

and the conservation of momentum

$$\rho \left(\frac{\partial v_k}{\partial t} + v_{k,l}v_l \right) = t_{kl,l} - p_{,k} + \rho f_k \quad (35)$$

this equation can also be written as

$$\rho \frac{D[\varepsilon + v_k v_k / 2]}{Dt} = (v_k t_{kl})_{,l} - (pv_k)_{,k} + \rho v_k f_k - q_{k,k} + \rho h^\theta, \quad (36)$$

or

$$\rho \frac{D[h + v_k v_k / 2]}{Dt} = (v_k t_{kl})_{,l} + \frac{\partial p}{\partial t} + \rho v_k f_k - q_{k,k} + \rho h^\theta, \quad (37)$$

where $h = \varepsilon + p/\rho$ is the enthalpy. For an ideal gas one can write $h = c_p T$, c_p is the heat capacity at constant pressure.

The total temperature T_t is now defined as the temperature which is obtained by slowing down the fluid to zero velocity in an adiabatic way. Using the energy equation (37), dropping the first term on the right hand side because of ideal gas conditions (no viscosity), the second term because of stationarity, the third term because of the absence of volumetric forces and the last two terms because of adiabatic conditions one obtains the relationship:

$$\rho \frac{D[c_p T + v_k v_k / 2]}{Dt} = 0, \quad (38)$$

along a stream line (recall that the meaning of the total derivative DX/Dt is the change of X following a particle), from which

$$T_t = T + \frac{v^2}{2c_p}, \quad (39)$$

where v is the magnitude of the velocity. The Mach number is defined by

$$M = \frac{v}{\sqrt{\kappa r T}}, \quad (40)$$

where κ is the specific heat ratio and the denominator is the speed of sound. Therefore, the total temperature satisfies:

$$T_t = T \left(1 + \frac{\kappa - 1}{2} M^2 \right). \quad (41)$$

The total pressure is defined as the pressure which is attained by slowing down the fluid flow in an isentropic way, i.e. a reversible adiabatic way. An ideal gas is isentropic if $p^{1-\kappa}T^\kappa$ is constant, which leads to the relationship

$$\frac{p_t}{p} = \left(\frac{T_t}{T}\right)^{\frac{\kappa}{\kappa-1}}, \quad (42)$$

and consequently to

$$p_t = p\left(1 + \frac{\kappa-1}{2}M^2\right)^{\frac{\kappa}{\kappa-1}}. \quad (43)$$

Substituting the definition of mass flow $\dot{m} = \rho Av$, where A is the cross section of the fluid channel, in the definition of the Mach number (and using the ideal gas equation to substitute ρ) leads to

$$M = \frac{\dot{m}\sqrt{rT}}{Ap\sqrt{\kappa}}. \quad (44)$$

Expressing the pressure and temperature as a function of the total pressure and total temperature, respectively, finally leads to

$$\frac{\dot{m}\sqrt{rT_t}}{Ap_t\sqrt{\kappa}} = M \left(1 + \frac{\kappa-1}{2}M^2\right)^{-\frac{(\kappa+1)}{2(\kappa-1)}}. \quad (45)$$

This is the general gas equation, which applies to all types of flow for ideal gases. The left hand side is called the corrected flow. The right hand side exhibits a maximum for $M = 1$, i.e. sonic conditions.

It is further possible to derive general statements for isentropic flow through network elements. Isentropic flow is reversible adiabatic by definition. Due to the adiabatic conditions the total enthalpy $h_t = c_p T_t$ is constant or

$$dh + vdv = 0. \quad (46)$$

The first law of thermodynamics (conservation of energy) specifies that

$$d\varepsilon = \delta q + \delta w, \quad (47)$$

or, because of the adiabatic and reversible conditions

$$d\varepsilon = -pd\left(\frac{1}{\rho}\right). \quad (48)$$

Since the enthalpy $h = \varepsilon + p/\rho$, one further obtains

$$dh = dp/\rho. \quad (49)$$

Substituting this in the equation we started from leads to:

$$dp = -\rho vdv. \quad (50)$$

The continuity equation through a network element with cross section A , $\rho v A = \text{constant}$ can be written in the following differential form:

$$\frac{d\rho}{\rho} + \frac{dv}{v} + \frac{dA}{A} = 0, \quad (51)$$

or, with the equation above

$$\frac{d\rho}{\rho} - \frac{dp}{\rho v^2} + \frac{dA}{A} = 0, \quad (52)$$

which leads to

$$\frac{dA}{A} = \frac{dp}{\rho v^2} - \frac{d\rho}{\rho} = \frac{dp}{\rho v^2} \left(1 - \frac{v^2}{\left(\frac{dp}{d\rho}\right)} \right). \quad (53)$$

Since $\sqrt{\frac{dp}{d\rho}}$ is the speed of sound (use the isentropic relation $p \propto \rho^\kappa$ and the ideal gas equation $p = \rho r T$ to arrive at $dp/d\rho = \kappa r T = c^2$), one arrives at:

$$\frac{dA}{A} = \frac{dp}{\rho v^2} (1 - M^2) = -\frac{dv}{v} (1 - M^2). \quad (54)$$

Therefore, for subsonic network flow an increasing cross section leads to a decreasing velocity and an increasing pressure, whereas a decreasing cross section leads to an increasing velocity and a decreasing pressure. This is similar to what happens for incompressible flow in a tube.

For supersonic flow an increasing cross section leads to an increasing velocity and a decreasing pressure whereas a decreasing cross section leads to a decreasing velocity and an increasing pressure.

Sonic conditions can only occur if $dA = 0$, in reality this corresponds to a minimum of the cross section. Therefore, if we assume that the network elements are characterized by a uniformly increasing or decreasing cross section sonic conditions can only occur at the end nodes. This is important information for the derivation of the specific network element equations.

Using the definition of entropy per unit mass s satisfying $T ds = \delta q$ and the definition of enthalpy the first law of thermodynamics for reversible processes runs like

$$dh = T ds + \frac{dp}{\rho}. \quad (55)$$

Therefore

$$ds = \frac{dh}{T} - \frac{dp}{\rho T}. \quad (56)$$

For an ideal gas $dh = c_p(T) dT$ and $p = \rho r T$ and consequently

$$ds = c_p(T) \frac{dT}{T} - r \frac{dp}{p} \quad (57)$$

or

$$s_2 - s_1 = \int_{T_1}^{T_2} c_p(T) \frac{dT}{T} - r \ln \frac{p_2}{p_1}. \quad (58)$$

Since all variables in the above equation are state variables, it also applies to irreversible processes. If the specific heat is temperature independent one obtains

$$s_2 - s_1 = c_p \ln \frac{T_2}{T_1} - r \ln \frac{p_2}{p_1}, \quad (59)$$

linking the entropy difference between two states to the temperature and pressure difference.

Typical material properties needed for a gas network are the specific gas constant r (*SPECIFIC GAS CONSTANT card), the heat capacity at constant pressure c_p and the dynamic viscosity μ (both temperature dependent and to be specified with the FLUID CONSTANTS card).

A special case is the purely thermal gas network. This applies if:

- no TYPE is specified on any *FLUID SECTION card or
- the parameter THERMAL NETWORK is used on the *STEP card or
- all mass flow is given and either all pressures or given or none.

In that case only c_p is needed.

A network element is characterized by a type of fluid section. It has to be specified on the *FLUID SECTION card unless the analysis is a pure thermo-mechanical calculation. For gases, several types are available. At the start of the description of each type the main properties are summarized: “adiabatic” means that no heat is exchanged within the element; “isentropic” refers to constant entropy, i.e. flow without losses; “symmetric” means that the same relations apply for reversed flow; “directional” means that the flow is not allowed to be reversed.

All entries and exits in the network have to be characterized by a node with label zero. The element containing this node (entry and exit elements) can be of any type. For entry and exit elements no element equations are set up. The only effect the type has is whether the nonzero node is considered to be a chamber (zero velocity and hence the total temperature equals the static temperature) or a potential pipe connection (for a pipe connection node the total temperature does not equal the static temperature). The pipe connection types are GASPIPE, RESTRICTOR except for RESTRICTOR WALL ORIFICE and USER types starting with UP, all other types are chamber-like. A node is a pipe connection node if exactly two gas network elements are connected to this node and all of them are pipe connection types.

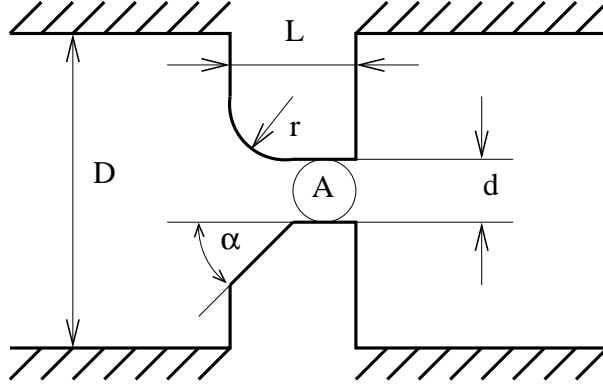

Figure 82: Geometry of the orifice fluid section

For chamber-like entry and exit elements it is strongly recommended to use the type INOUT.

6.4.1 Orifice

Properties: adiabatic, not isentropic, symmetric only if physically symmetric (i.e. same corner radius, corner angle etc.), else directional.

The geometry of the orifice fluid section is shown in Figure 82. The axis of the orifice goes through the center of gravity of the cross section A and is parallel to the side walls. The orifice is allowed to rotate about an axis parallel to the orifice axis and can be preceded by a swirl generating device such as another orifice, a bleed tapping or a preswirl nozzle.

The orifice element is characterized by an end node well upstream of the smallest section A (let's call this position 1) and an end node 2 well downstream of the smallest section (position 2). The smallest section of the gas stream is called position m . This may be smaller than A due to a contraction of the gas and will be written as $C_d A$, $C_d \leq 1$.

In between position 1 and m the flow is assumed to be isentropic, consequently

- the mass flow (\dot{m}) is constant
- the total temperature ($\frac{\kappa}{\kappa-1} \frac{p}{\rho} + \frac{v^2}{2}$) is constant
- p/ρ^κ is constant

where p is the static pressure. Furthermore $v_1 \ll v_m$ is assumed, since the cross section at position 1 is assumed to be large and consequently $p_{t_1} = p_1$, $T_{t_1} = T_1$.

Starting from the constancy of the total temperature between position 1 and m , inserting the isentropic relationship and neglecting v_1 leads to:

$$\frac{v_m^2}{2} = \left(\frac{\kappa}{\kappa - 1} \right) \left(\frac{p_1}{\rho_1} \right) \left[1 - \left(\frac{p_m}{p_1} \right)^{\frac{\kappa-1}{\kappa}} \right]. \quad (60)$$

Using the relationship $\dot{m} = \rho_m A_m v_m$ leads to:

$$\dot{m} = A_m \sqrt{p_1 \rho_1 \left(\frac{p_m}{p_1} \right)^{\frac{2}{\kappa}} \left(\frac{2\kappa}{\kappa - 1} \right) \left[1 - \left(\frac{p_m}{p_1} \right)^{\frac{\kappa-1}{\kappa}} \right]}. \quad (61)$$

Using $\rho_1 = p_1/(rT_1)$ and setting $A_m = C_d A$ one arrives at:

$$\frac{\dot{m} \sqrt{rT_1}}{C_d A p_1 \sqrt{\kappa}} = \sqrt{\frac{2}{\kappa - 1} \left(\frac{p_m}{p_1} \right)^{\frac{2}{\kappa}} \left[1 - \left(\frac{p_m}{p_1} \right)^{\frac{\kappa-1}{\kappa}} \right]}. \quad (62)$$

or taking into account that at position 1 total and static quantities coincide:

$$\frac{\dot{m} \sqrt{rT_{t_1}}}{C_d A p_{t_1} \sqrt{\kappa}} = \sqrt{\frac{2}{\kappa - 1} \left(\frac{p_m}{p_{t_1}} \right)^{\frac{2}{\kappa}} \left[1 - \left(\frac{p_m}{p_{t_1}} \right)^{\frac{\kappa-1}{\kappa}} \right]}. \quad (63)$$

In between position m and 2 the flow is assumed to be adiabatic, however, all kinetic energy from position m is assumed to be lost due to turbulence. Hence:

- the mass flow (\dot{m}) is constant
- the total temperature is constant
- p_t at position 2 is equal to p at position m .

Combining this leads to the following equation:

$$\frac{\dot{m} \sqrt{rT_{t_1}}}{C_d A p_{t_1} \sqrt{\kappa}} = \sqrt{\frac{2}{\kappa - 1} \left(\frac{p_{t_2}}{p_{t_1}} \right)^{\frac{2}{\kappa}} \left[1 - \left(\frac{p_{t_2}}{p_{t_1}} \right)^{\frac{\kappa-1}{\kappa}} \right]}. \quad (64)$$

Let us assume that $\frac{p_{t_2}}{p_{t_1}}$ is being slowly decreased starting from 1. Then the above equation will result in a steadily increasing mass flow rate up to a maximum at (Figure 83)

$$\frac{p_{t_2}}{p_{t_1}} = \left(\frac{2}{\kappa + 1} \right)^{\frac{\kappa}{\kappa-1}}, \quad (65)$$

after which the mass flow rate starts to decrease again [69]. In reality, the decrease does not happen and the mass flow rate remains constant. Indeed, at maximum corrected flow sonic conditions are reached (so-called critical conditions). For lower values of $\frac{p_{t_2}}{p_{t_1}}$ the flow is supersonic, which means that waves

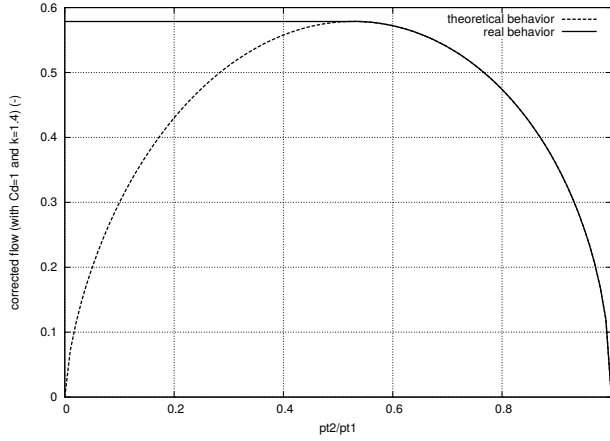

Figure 83: Theoretical and choking behavior of the orifice

cannot travel upstream. Therefore, the information that the pressure ratio has decreased below the critical ratio cannot travel upstream and the critical corrected flow persists throughout. Consequently, for

$$\frac{p_{t2}}{p_{t1}} \leq \left(\frac{2}{\kappa + 1} \right)^{\frac{\kappa}{\kappa - 1}}, \quad (66)$$

Equation (64) is replaced by

$$\frac{\dot{m} \sqrt{r T_{t1}}}{C_d A p_{t1} \sqrt{\kappa}} = \sqrt{\left(\frac{\kappa + 1}{2} \right)^{-\frac{\kappa + 1}{\kappa - 1}}}. \quad (67)$$

The orifice element is characterized by the following constants (to be specified in that order on the line beneath the *FLUID SECTION card):

- the cross section A .
- the orifice diameter d (not needed for $C_d = 1$).
- the length L (not needed for $C_d = 1$).
- the inlet corner radius r (mutually exclusive with α ; not needed for $C_d = 1$).
- the inlet corner angle α in $^\circ$ (mutually exclusive with r ; not needed for $C_d = 1$).
- the orifice-to-upstream pipe diameter ratio $\beta = d/D$ (only for TYPE=ORIFICE_PK_MS).
- the rotational velocity v , if the orifice is part of a rotating structure (not needed for $C_d = 1$).

- a reference network element (not needed for $C_d = 1$).

Depending on the orifice geometry, an inlet corner radius or an inlet corner angle (chamfered inlet) should be selected. They are mutually exclusive. The corrections for a chamfered inlet are taken from [34].

The last constant, i.e. the number of a reference network element, is necessary in case a rotating structure is preceded by a network element which diverts the upstream air velocity from the axial (i.e. in the direction of the axis of the orifice) direction (such as a preswirl nozzle). In that case, the rotational velocity of the orifice has to be corrected by the circumferential component of the velocity at the exit of the preceding element.

Notice that the only effect of all constants following the cross section is to change the discharge coefficient C_d . Its calculation can be performed according to different formulas. This is selected by the TYPE parameter:

- TYPE=ORIFICE_CD1 or just TYPE=ORIFICE: $C_d = 1$.
- TYPE=ORIFICE_MS_MS: Basis formula by McGreehan and Schotsch, rotational correction by McGreehan and Schotsch [55].
- TYPE=ORIFICE_PK_MS: Basis formula by Parker and Kercher [72], rotational correction by McGreehan and Schotsch [55].

By specifying the parameter LIQUID on the *FLUID SECTION card the loss is calculated for liquids (only for $C_d = 1$). In the absence of this parameter, compressible losses are calculated.

Example files: linearnet, vortex1.

6.4.2 Bleed Tapping

A bleed tapping device is a special kind of static orifice (Figure 84), used to divert part of the main stream flow. The geometry can be quite complicated and the discharge coefficient should be ideally determined by experiments on the actual device. The basic equations are the same as for the orifice, only the discharge coefficient is different.

The discharge coefficients provided by CalculiX are merely a rough estimate and are based on [45]. For this purpose the bleed tapping device must be described by the following constants (to be specified in that order on the line beneath the *FLUID SECTION, TYPE=BLEED TAPPING card):

- the cross section A .
- the ratio of the upstream static pressure to the upstream total pressure p_{s1}/p_{t1} .
- the number of a curve.

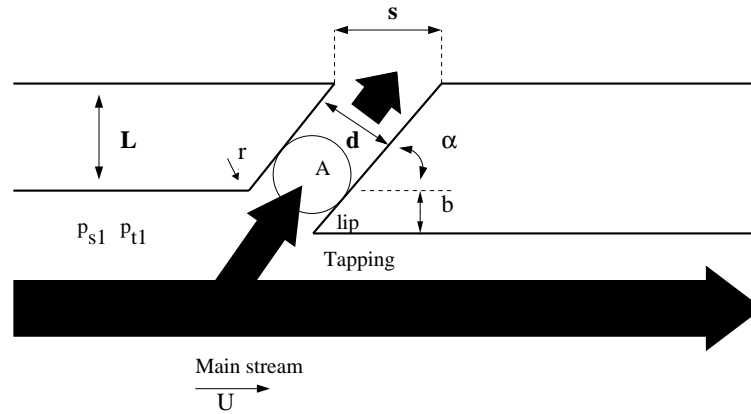

Figure 84: Geometry of the bleed tapping fluid section

Right now, two curves are coded: curve number 1 corresponds to a tapping device with lip, curve number 2 to a tapping device without lip. More specific curves can be implemented by the user, the appropriate routine to do so is `cd_bleedtapping.f`. Alternatively, the user can enter an own curve in the input deck listing $Y = C_d$ versus $X = (1 - p_{s2}/p_{t1})/(1 - p_{s1}/p_{t1})$. In that case the input reads

- the cross section A .
- the ratio of the upstream static pressure to the upstream total pressure p_{s1}/p_{t1} .
- not used
- not used (internally: number of pairs)
- X_1 .
- Y_1 .
- X_2 .
- Y_2 .
- .. (maximum 16 entries per line; maximum of 18 pairs in total)

6.4.3 Preswirl Nozzle

A preswirl nozzle is a special kind of static orifice (Figure 85), used to impart a tangential velocity to gas before it enters a rotating device. That way, the loss due to the difference in circumferential velocity between the air entering the rotating device and the rotating device itself can be decreased. In the Figure v_{rot} is the rotational velocity of the orifice the preswirl nozzle is serving, v_{abs} is

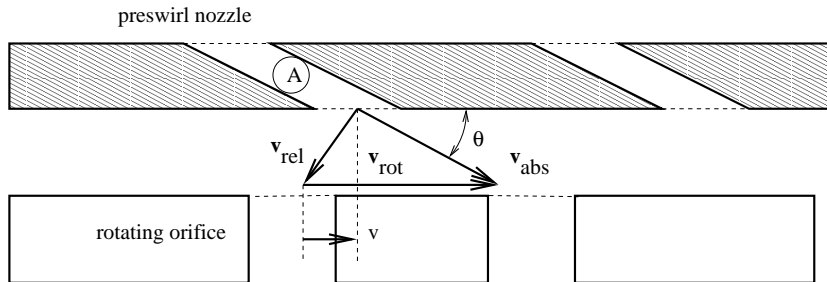

Figure 85: Geometry of the preswirl nozzle fluid section and the orifice it serves

the absolute velocity of the air leaving the preswirl nozzle and \mathbf{v}_{rel} is its velocity as seen by an observer rotating with the orifice (the so-called relative velocity). The velocity entering the calculation of the discharge coefficient of the rotating orifice is the tangential component v of the velocity of the rotating device as seen by the air leaving the preswirl nozzle (which is $-\mathbf{v}_{rel}$). This velocity can be modified by a multiplicative factor k_ϕ .

The geometry of a preswirl nozzle can be quite complicated and the discharge coefficient should be ideally determined by experiments on the actual device. The basic equations are the same as for the orifice.

The discharge coefficients provided by CalculiX are merely a rough estimate and are based on [45]. For this purpose the preswirl nozzle must be described by the following constants (to be specified in that order on the line beneath the *FLUID SECTION, TYPE=PRESWIRL NOZZLE card):

- the cross section A .
- θ (Figure 85) in $^\circ$.
- k_ϕ .
- the number of a curve (0 for the predefined curve).
- not used (internally: circumferential velocity at the outlet)

The angle at the exit of the nozzle is used to determine the circumferential velocity of the gas leaving the nozzle. This is stored for use in the (rotating) device following the nozzle. The curve number can be used to distinguish between several measured curves. Right now, only one curve is coded (number = 0 to select this curve). More specific curves can be implemented by the user, the appropriate routine to do so is `cd_preswirlnozzle.f`. Alternatively, the user can enter an own curve in the input deck listing $Y = C_d$ versus $X = p_{s2}/p_{t1}$. In that case the input reads

- the cross section A .
- θ (Figure 85) in $^\circ$.

- k_ϕ .
- not used.
- not used (internally: circumferential velocity at the outlet).
- not used (internally: number of pairs).
- X_1 .
- Y_1 .
- X_2 .
- Y_2 .
- .. (maximum 16 entries per line; maximum 17 pairs in total)

Example files: moehring, vortex1, vortex2, vortex3.

6.4.4 Straight and Stepped Labyrinth

A labyrinth is used to prevent the gas from leaking through the space between a rotating and a static device and thus reducing the efficiency. The leaking air is trapped in the successive stages of a labyrinth. It can be straight (Figure 86) or stepped (Figure 87). A stepped labyrinth is used if the gas is compressed or expanded, leading to a decreasing and increasing diameter of the rotating device, respectively. In a stepped labyrinth the static device (hatched in Figures 86 and 87) is usually covered by a honeycomb structure.

A LABYRINTH can be single (only one spike) or multiple (more than one spike). Only in the latter case the distinction between a straight and stepped labyrinth makes sense. Therefore, there are three kinds of labyrinths: single, straight or stepped.

The geometry of a labyrinth can be fixed or flexible during a calculation. For a fixed geometry the gap distance s is constant. For a flexible geometry this gap is defined as the radial distance between two nodes (this feature only works if the structure is defined as in the presence of axisymmetric elements, i.e. the global x-axis is the radial direction, the global y-axis is the axial direction). These nodes have to be genuine structural nodes and should not belong to the fluid network. In a thermomechanical calculation this distance can vary during the computation. Whether the geometry is fixed or flexible is defined by the TYPE parameter.

The formula governing the flow through a labyrinth has been derived in [24] and for the discharge coefficients use was made of [55], [50], [14] and [113]. It runs like

$$\frac{\dot{m}\sqrt{rT_{t_1}}}{Ap_{t_1}} = \lambda \sqrt{\frac{1 - \left(\frac{p_{t_2}}{p_{t_1}}\right)^2}{n - \ln\left(\frac{p_{t_2}}{p_{t_1}}\right)}}, \quad (68)$$

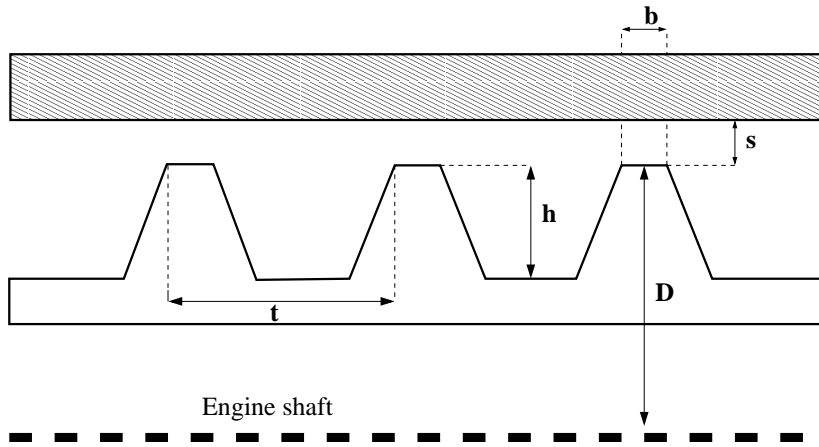

Figure 86: Geometry of straight labyrinth

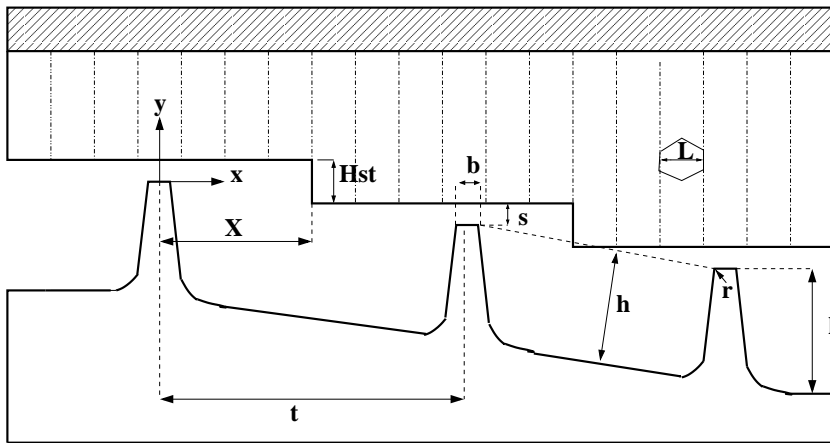

Figure 87: Geometry of stepped labyrinth

where $\lambda = 1$ for $n = 1$ and

$$\lambda = \sqrt{\frac{\left(\frac{n}{n-1}\right)}{1 - \left(\frac{n-1}{n}\right) \left(\frac{s/t}{s/t+0.02}\right)}} \quad (69)$$

for $n > 1$ is called the carry-over factor. The meaning of the parameters n , s and t is explained underneath. Equation (68) has a similar form as the orifice equation, i.e. for small downstream pressures the flow becomes supersonic and choking occurs. To determine the pressure ration $x = \frac{p_{t2}}{p_{t1}}$ at which choking occurs the following implicit equation has to be solved:

$$x\sqrt{1 + 2n - \ln x^2} = 1. \quad (70)$$

The equations used in the code are slightly more complicated, making use of the other parameters (r , X , $Hst...$) as well.

A fixed labyrinth is described by the following parameters (to be specified in that order on the line beneath the *FLUID SECTION, TYPE=LABYRINTH SINGLE, TYPE=LABYRINTH STRAIGHT or TYPE=LABYRINTH STEPPED card):

- t: distance between two spikes (only for more than 1 spike)
- s: gap between the top of the spike and the stator
- not used
- D: Diameter of the top of the spike (for the stepped labyrinth a mean value should be used; the diameter is needed to calculate the fluid cross section as πDs).
- n: number of spikes
- b: width of the top of the spike
- h: height of the spike measured from the bottom of the chamber
- L: width of a honeycomb cell
- r: edge radius of a spike
- X: distance between the spike and the next step (only for more than 1 spike)
- Hst: height of the step (only for a stepped labyrinth)

A flexible labyrinth is described by the following parameters (to be specified in that order on the line beneath the *FLUID SECTION, TYPE=LABYRINTH FLEXIBLE SINGLE, TYPE=LABYRINTH FLEXIBLE STRAIGHT or TYPE=LABYRINTH FLEXIBLE STEPPED card):

- number of the first node defining the labyrinth gap
- number of the second node defining the labyrinth gap
- not used
- t: distance between two spikes (only for more than 1 spike)
- D: Diameter of the top of the spike (for the stepped labyrinth a mean value should be used; the diameter is needed to calculate the fluid cross section as πDs).
- n: number of spikes
- b: width of the top of the spike
- h: height of the spike measured from the bottom of the chamber
- L: width of a honeycomb cell
- r: edge radius of a spike
- X: distance between the spike and the next step (only for more than 1 spike)
- Hst: height of the step (only for a stepped labyrinth)

Please look at the figures for the meaning of these parameters. Depending on the kind of labyrinth, not all parameters may be necessary.

Example files: labyrinthstepped, labyrinthstraight.

6.4.5 Characteristic

Properties: adiabatic, not isentropic, symmetric

Sometimes a network element is described by its characteristic curve, expressing the reduced mass flow as a function of the pressure ratio (Figure 88). This allows the user to define new elements not already available.

The reduced flow is defined by

$$Y = \frac{\dot{m}\sqrt{T_{t_1}}}{p_{t_1}}, \quad (71)$$

where \dot{m} is the mass flow, T_{t_1} is the upstream total temperature and p_{t_1} is the upstream total pressure. Here “upstream” refers to the actual flow direction, the same applies to “downstream”. The abscissa of the curve is defined by

$$X = \frac{p_{t_1} - p_{t_2}}{p_{t_1}}, \quad (72)$$

where p_{t_2} is the downstream total pressure. Notice that $0 \leq X \leq 1$. It is advisable to define Y for the complete X-range. If not, constant extrapolation

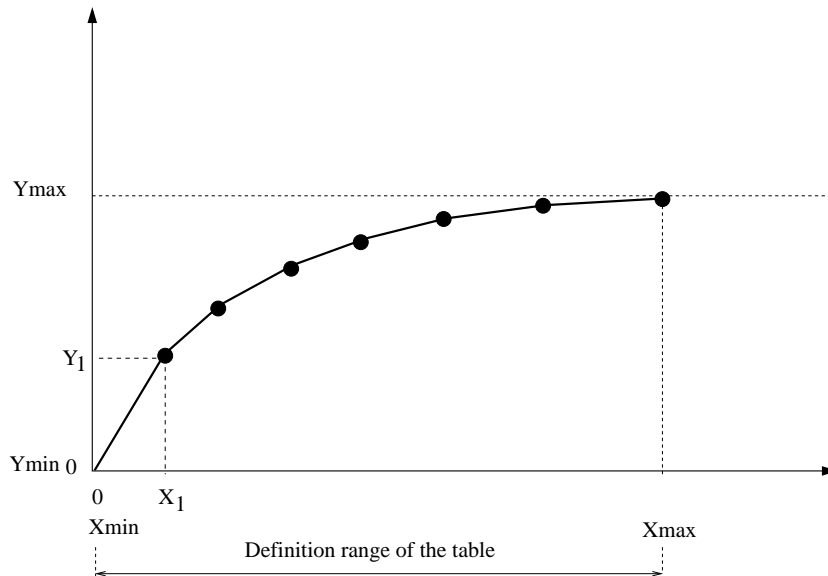

Figure 88: Characteristic Curve

applies. Notice that zero and small slopes of the curve can lead to convergence problems. This is quite natural, since the reduced flow corresponds to the left hand side of Equation(45), apart from a constant. Zero slope implies a maximum, which corresponds to sonic flow (cf. the discussion of Equation(45)). In general, some sort of saturation will occur for values of X close to 1.

The characteristic curve is defined by the following parameters (to be specified in that order on the line beneath the *FLUID SECTION, TYPE=CHARACTERISTIC card):

- scaling factor (default: 1)
- not used (internally: number of pairs)
- not used (internally: set to zero)
- not used (internally: set to zero)
- X_1
- Y_1
- X_2
- Y_2

Use more cards if more than two pairs are needed (maximum 16 entries per line, i.e. 8 pairs). No more than 10 pairs in total are allowed. In between

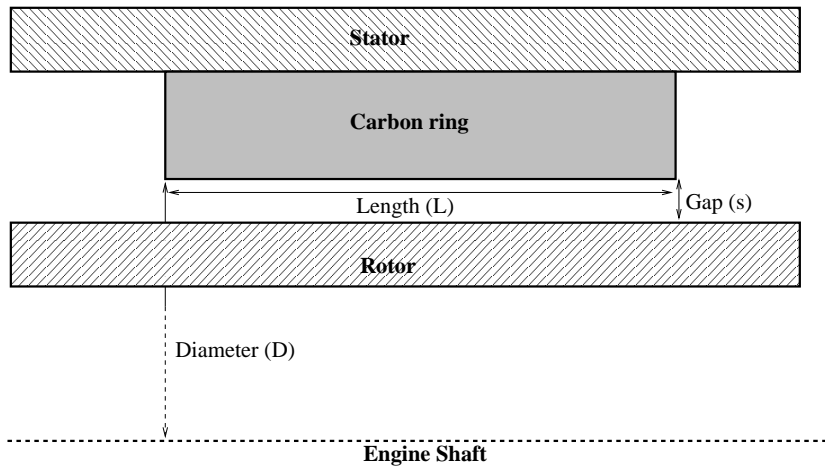

Figure 89: Geometry of a carbon seal

the data points CalculiX performs an interpolation (solid line in Figure 88). In addition, the default point (0,0) is added as first point of the curve.

The scaling factor (first entry) is used to scale the ordinate values Y .

Example files: characteristic.

6.4.6 Carbon Seal

A carbon seal is used to prevent the gas from leaking through the space between a rotating and a static device and thus reducing the efficiency (Figure 89).

The formula governing the flow through a carbon seal has been derived in [81]. A carbon seal is described by the following parameters (to be specified in that order on the line beneath the *FLUID SECTION,TYPE=CARBON SEAL card):

- D : largest diameter of the gap
- s : size of the gap between rotor and carbon ring
- L : length of the carbon seal

Please look at the figure for the meaning of these parameters.

Example files: carbonseal.

6.4.7 Gas Pipe (Fanno)

The gas pipe element of type Fanno is a pipe element with constant cross section (Figure 90), for which the Fanno formulae are applied [96].

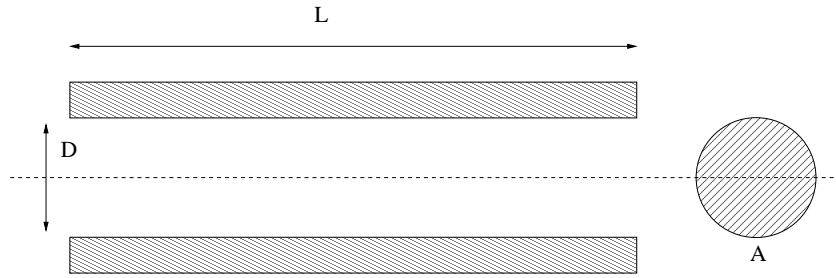

Figure 90: Geometry of the Gas Pipe element

The friction parameter is determined as

$$f = \frac{64}{\text{Re}} \quad (73)$$

for laminar flow ($\text{Re} < 2000$) and

$$\frac{1}{\sqrt{f}} = -2.03 \log \left(\frac{2.51}{\text{Re}\sqrt{f}} + \frac{k_s}{3.7D} \right). \quad (74)$$

for turbulent flow. Here, k_s is the diameter of the material grains at the surface of the pipe and Re is the Reynolds number defined by

$$\text{Re} = \frac{UD}{\nu}, \quad (75)$$

where U is the fluid velocity and ν is the kinematic viscosity.

It is described by the following parameters (to be specified in that order on the line beneath the *FLUID SECTION,TYPE=GAS PIPE FANNO ADIABATIC or *FLUID SECTION,TYPE=GAS PIPE FANNO ISOTHERMAL card):

- A: cross section of the pipe element
- D: diameter of the pipe element
- L: length of the pipe element
- k_s : grain diameter at the pipe surface
- form factor φ
- oil mass flow in the pipe (only if the OIL parameter is used to define the kind of oil in the *FLUID SECTION card)
- not used (internally: oil material number)

The default gas pipe is adiabatic, i.e. there is no heat exchange with the pipe. Alternatively, the user may specify that the pipe element is isothermal. This means that the static temperature does not change within the pipe. In that case the energy equation in one of the two end nodes of the element is replaced by an isothermal condition.

The form factor φ is only used to modify the friction expression for non-circular cross sections in the laminar regime as follows:

$$f = \varphi \frac{64}{\text{Re}}. \quad (76)$$

Values for φ for several cross sections can be found in [13]. For a square cross section its value is 0.88, for a rectangle with a height to width ratio of 2 its value is 0.97.

Instead of specifying a fixed diameter and length, these measures may also be calculated from the actual position of given nodes. The version in which the radius is calculated from the actual distance between two nodes a and b is described by the following parameters (to be specified in that order on the line beneath the *FLUID SECTION,TYPE=GAS PIPE FANNO ADIABATIC FLEXIBLE RADIUS or *FLUID SECTION,TYPE=GAS PIPE FANNO ISOTHERMAL FLEXIBLE RADIUS card):

- node number a
- node number b
- L: length of the pipe
- k_s : grain diameter at the pipe surface
- form factor φ
- oil mass flow in the pipe (only if the OIL parameter is used to define the kind of oil in the *FLUID SECTION card)
- not used (internally: oil material number)

The version in which the radius is calculated from the actual distance between two nodes a and b and the length from the actual distance between nodes a and c is described by the following parameters (to be specified in that order on the line beneath the *FLUID SECTION,TYPE=GAS PIPE FANNO ADIABATIC FLEXIBLE RADIUS AND LENGTH or *FLUID SECTION,TYPE=GAS PIPE FANNO ISOTHERMAL FLEXIBLE RADIUS AND LENGTH card):

- node number a
- node number b
- node number c
- k_s : grain diameter at the pipe surface

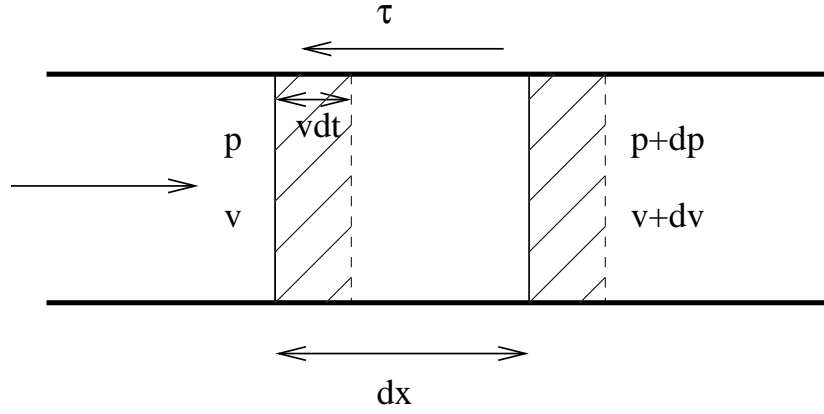

Figure 91: Differential pipe element

- form factor φ
- oil mass flow in the pipe (only if the OIL parameter is used to define the kind of oil in the *FLUID SECTION card)
- not used (internally: oil material number)

Although a gas pipe looks simple, the equations for compressible flow in a pipe are quite complicated. Here, the derivation is first presented for the adiabatic case. Starting from the energy equation (46) and using the relation $dh = c_p dT$ for an ideal gas one arrives at:

$$c_p dT + v dv = 0. \quad (77)$$

By means of the definition of the Mach number (40) one gets

$$\frac{dT}{T} = -(\kappa - 1)M^2 \frac{dv}{v}. \quad (78)$$

Because of the ideal gas equation $p = \rho r T$ this can also be written as:

$$\frac{dp}{p} = -[1 + (\kappa - 1)M^2] \frac{dv}{v}. \quad (79)$$

Looking at Figure (91) the momentum equation can be derived by applying Newton's second law, which states that the sum of the forces is the change of momentum (D is the diameter of the pipe, A its cross section):

$$Ap - A(p + dp) - \tau \pi D dx = \frac{\rho A v dt (v + dv) - \rho A v dt (v)}{dt}, \quad (80)$$

or, using Darcy's law (λ is the Darcy friction factor)

$$\tau = \frac{\lambda}{4} \frac{\rho}{2} v^2, \quad (81)$$

$$\rho \frac{dv^2}{2} + dp + \frac{\lambda}{D} \frac{\rho}{2} v^2 dx = 0. \quad (82)$$

One can remove the density by means of the gas equation arriving at:

$$v^2 \frac{dv}{v} + rT \frac{dp}{p} + \frac{\lambda}{2} v^2 \frac{dx}{D} = 0. \quad (83)$$

Combining this with what was obtained through the energy equation (79) leads to (removing p in this process):

$$\frac{dv}{v} - \frac{\kappa\lambda}{2} \left(\frac{M^2}{1-M^2} \right) \frac{dx}{D} = 0. \quad (84)$$

This equation contains both M and v . We would like to get an equation with only one of these parameters. To this end the equation defining the Mach number (40) is differentiated and the energy equation in the form (77) is used to remove T , leading to:

$$\frac{dM}{M} = \frac{dv}{v} \left(1 + \frac{1}{2}(\kappa - 1)M^2 \right). \quad (85)$$

In that way, the previous equation can be modified its final form:

$$\frac{dM}{M} = \frac{\kappa M^2}{2(1-M^2)} \left(1 + \frac{\kappa-1}{2} M^2 \right) \lambda \frac{dx}{D}, \quad (86)$$

expressing the Mach number as a function of the distance along the pipe. This equation tells us that for subcritical flow ($M < 1$) the Mach number increases along the pipe whereas for supercritical flow ($M > 1$) the Mach number decreases. Consequently, the flows tends to $M = 1$ along the pipe. Notice that by assigning the sign of v to λ the above equation also applies to negative velocities. Substituting $Z = M^2$ and integrating both sides yields:

$$\int_{Z_1}^{Z_2} \frac{1-Z}{\kappa Z^2} \frac{1}{(1+\frac{\kappa-1}{2}Z)} dZ = \int_0^L \lambda \frac{dx}{D}. \quad (87)$$

Since (partial fractions)

$$\frac{1-Z}{Z^2(1+\frac{\kappa-1}{2}Z)} = -\frac{\kappa+1}{2} \frac{1}{Z} + \frac{1}{Z^2} + \left(\frac{\kappa-1}{2} \right) \left(\frac{\kappa+1}{2} \right) \frac{1}{(1+\frac{\kappa-1}{2}Z)}, \quad (88)$$

one obtains finally

$$\frac{1}{\kappa} \left(\frac{1}{M_1^2} - \frac{1}{M_2^2} \right) + \frac{\kappa+1}{2\kappa} \ln \left[\left(\frac{1+\frac{\kappa-1}{2}M_2^2}{1+\frac{\kappa-1}{2}M_1^2} \right) \left(\frac{M_1^2}{M_2^2} \right) \right] = \lambda \frac{L}{D}, \quad (89)$$

linking the Mach number M_1 at the start of the pipe with the Mach number M_2 at the end of the pipe, the pipe length L and the Darcy friction coefficient λ .

Notice that Equation (83) can be used to calculate an estimate of the mass flow due to a given pressure gradient by assuming incompressibility. For an incompressible medium in a pipe with constant cross section the velocity is constant too (mass conservation) and Equation (83) reduces to:

$$\frac{dp}{\rho} + \frac{\lambda}{2} v^2 \frac{dx}{D} = 0. \quad (90)$$

Integrating yields:

$$v = \sqrt{\frac{2D}{\lambda L} \frac{(p_1 - p_2)}{\rho}}, \quad (91)$$

or

$$\dot{m} = A \sqrt{\frac{2D}{\lambda L} \rho (p_1 - p_2)}, \quad (92)$$

which can finally also be written as:

$$\dot{m} = A \sqrt{\frac{2D}{\lambda L} \frac{p_1}{rT_1} (p_1 - p_2)}. \quad (93)$$

For an estimate of the mass flow in the gas pipe the above static variables p and T are replaced by the total variables p_t and T_t , respectively. Equation (89) is the governing equation for an adiabatic gas pipe. In order to apply the Newton-Raphson procedure (linearization of the equation) with respect to the variables T_{t1} , p_{t1} , \dot{m} , T_{t2} and p_{t2} , this equation is first derived w.r.t M_1 and M_2 (denoting the equation by f ; the derivation is slightly tedious but straightforward):

$$\frac{\partial f}{\partial M_1} = \frac{2}{\kappa M_1} \left[\frac{M_1^2 - 1}{M_1^2 (1 + bM_1^2)} \right], \quad (94)$$

and

$$\frac{\partial f}{\partial M_2} = \frac{2}{\kappa M_2} \left[\frac{1 - M_2^2}{M_2^2 (1 + bM_2^2)} \right], \quad (95)$$

where $b = (\kappa - 1)/2$. Now, M at position 1 and 2 is linked to T_t , p_t and \dot{m} at the same location through the general gas equation:

$$\dot{m} = \frac{ap_t}{\sqrt{T_t}} M (1 + bM^2)^c, \quad (96)$$

where $a = A\sqrt{\kappa}/\sqrt{r}$ and $c = -(\kappa + 1)/(2(\kappa - 1))$. Careful differentiation of this equation leads to the surprisingly simple expression:

$$dM = e \frac{d\dot{m}}{\dot{m}} - e \frac{dp_t}{p_t} + e \frac{dT_t}{2T_t}, \quad (97)$$

where

$$e = \left[\frac{M(1 + bM^2)}{1 + bM^2(1 + 2c)} \right]. \quad (98)$$

Finally, the chain rule leads to the expressions looked for:

$$\frac{\partial f}{\partial T_{t1}} = \frac{\partial f}{\partial M_1} \cdot \frac{\partial M_1}{\partial T_{t1}}, \quad (99)$$

etc.

For the isothermal pipe the ideal gas equation leads to:

$$\frac{dp}{p} = \frac{d\rho}{\rho} \quad (100)$$

and from the mass conservation, Equation (51) one gets:

$$\frac{dp}{p} = -\frac{dv}{v}. \quad (101)$$

Furthermore, the definition of the Mach number yields:

$$\frac{dv}{v} = \frac{dM}{M}, \quad (102)$$

finally leading to:

$$\frac{dv}{v} = \frac{dM}{M} = -\frac{dp}{p} = -\frac{d\rho}{\rho}. \quad (103)$$

By substituting these relationships and the definition of the Mach number one can reduce all variables in Equation (83) by the Mach number, leading to:

$$(1 - \kappa M^2) \frac{dM}{M^3} = \frac{\kappa \lambda dx}{2 D}. \quad (104)$$

This equation shows that for an isothermal gas pipe the flow tends to $M = 1/\sqrt{\kappa}$ and not to 1 as for the adiabatic pipe. Substituting $Z = M^2$ and integrating finally yields:

$$\frac{1}{\kappa} \left(\frac{1}{M_1^2} - \frac{1}{M_2^2} \right) + \ln \left(\frac{M_1^2}{M_2^2} \right) = \lambda \frac{L}{D}. \quad (105)$$

The above equation constitutes the element equation of the isothermal gaspipe. Applying the Newton-Raphson procedure requires the knowledge of the derivatives w.r.t. the basis variables. The procedure is similar as for the adiabatic gas pipe. The derivative of the element equation w.r.t. M_1 and M_2 is easily obtained (denoting the left side of the above equation by f):

$$\frac{\partial f}{\partial M_1} = \frac{2}{\kappa M_1^3} (\kappa M_1^2 - 1) \quad (106)$$

and

$$\frac{\partial f}{\partial M_2} = \frac{2}{\kappa M_2^3} (1 - \kappa M_2^2). \quad (107)$$

The use of an isothermal gas pipe element, however, also requires the change of the energy equation. Indeed, in order for the gas pipe to be isothermal heat has to be added or subtracted in one of the end nodes of the element. The calculation of this heat contribution is avoided by replacing the energy equation in the topologically downstream node (or, if this node has a temperature boundary condition, the topologically upstream node) by the requirement that the static temperature in both end nodes of the element has to be the same. This is again a nonlinear equation in the basic unknowns (total temperature and total pressure in the end nodes, mass flow in the middle node) and has to be linearized. In order to find the derivatives one starts from the relationship between static and total temperature:

$$T_t = T(1 + bM^2), \quad (108)$$

where $b = (\kappa - 1)/2$. Differentiation yields:

$$dT_t = dT(1 + bM^2) + 2bTMdM. \quad (109)$$

Replacing dM by Equation (97) finally yields an expression in which dT is expressed as a function of dT_t , dp_t and dm .

Example files: gaspipe10, gaspipe8-cfd-massflow, gaspipe8-oil.

6.4.8 Rotating Gas Pipe (subsonic applications)

In the present section a rotating gas pipe with a varying cross section and friction is considered. Although the gas pipe Fanno is a special case of the rotating gas pipe, its governing equations constitute a singular limit to the equations presented here. Therefore, for a gas pipe without rotation and with constant cross section the equations here do not apply. The equivalent of Equation (86) now reads ([30], Table 10.2 on page 515):

$$\frac{dM^2}{M^2} = \left[\frac{1 + \frac{\kappa-1}{2}M^2}{1 - M^2} \right] \left[-2 \frac{dA}{A} - \frac{r\omega^2}{c_p T_t} \left(\frac{\kappa+1}{\kappa-1} \right) dx + \frac{\lambda dx}{D} \kappa M^2 \right], \quad (110)$$

where r is the shortest distance from the rotational axis, ω is the rotational speed and A is the local cross section of the pipe. Assuming that the radius R of the pipe varies linearly along its length $0 \leq x \leq L$:

$$R(x) = \frac{(L-x)R_1 + xR_2}{L}, \quad (111)$$

one obtains for dA/A :

$$\frac{dA}{A} = \frac{2(R_2 - R_1)dx}{(L - x)R_1 + xR_2}. \quad (112)$$

Taking for r , R , D and T_t the mean of their values at the end of the pipe one obtains for the second term in Equation (110) $[\alpha + \beta M^2]dx$ where

$$\alpha = \frac{-8(D_2 - D_1)}{L(D_1 + D_2)} - (r_1 + r_2) \frac{\omega^2}{c_p(T_{t1} + T_{t2})} \left(\frac{\kappa + 1}{\kappa - 1} \right) \quad (113)$$

and

$$\beta = \frac{2\lambda\kappa}{D_1 + D_2}. \quad (114)$$

Therefore, Equation (110) can now be written as:

$$\frac{dZ}{Z} = \left[\frac{1 + \frac{\kappa-1}{2}Z}{1 - Z} \right] (\alpha + \beta Z)dx, \quad (115)$$

or (using partial fractions):

$$\frac{a}{Z} + \frac{b}{\alpha + \beta Z} + \frac{c}{1 + \frac{\kappa-1}{2}Z} = dx, \quad (116)$$

where

$$a = \frac{1}{\alpha}, \quad (117)$$

$$b = \frac{2(\alpha + \beta)\beta}{\alpha[\alpha(\kappa - 1) - 2\beta]} \quad (118)$$

and

$$c = \frac{-(1 + \kappa)(1 - \kappa)}{2[\alpha(1 - \kappa) + 2\beta]}. \quad (119)$$

From the above equations one notices that for a non-rotating pipe with constant cross section $\alpha = 0$ and a and b become undeterminate. Therefore, although the gas pipe Fanno is a special case, the present formulas cannot be used for this element type. Integrating Equation (116) leads to:

$$f := a \ln \frac{Z_2}{Z_1} + \frac{b}{\beta} \ln \frac{\alpha + \beta Z_2}{\alpha + \beta Z_1} + \frac{2c}{\kappa - 1} \ln \left(\frac{1 + \frac{\kappa-1}{2}Z_2}{1 + \frac{\kappa-1}{2}Z_1} \right) = L. \quad (120)$$

Its derivatives are:

$$\frac{\partial f}{\partial M_1} = - \left[\frac{a}{Z_1} + \frac{b}{(\alpha + \beta Z_1)} + \frac{c}{(1 + \frac{\kappa-1}{2}Z_1)} \right] 2M_1 \quad (121)$$

and

$$\frac{\partial f}{\partial M_2} = \left[\frac{a}{Z_2} + \frac{b}{(\alpha + \beta Z_2)} + \frac{c}{(1 + \frac{\kappa-1}{2} Z_2)} \right] 2M_2. \quad (122)$$

Focussing on the subsonic range, one has $0 \leq Z_1, Z_2 \leq 1$. Therefore, the only term in Equation (120) which may cause problems is the second term. This is because α and β do not necessarily have the same sign, therefore the logarithm may be undefined, i.e. the function $\alpha + \beta Z$ may have a zero in between the ends of the pipe. This boils down to the condition (cf. Equation (110)) that in part of the element the Mach number is increasing and in part decreasing.

In general, convergence of a pipe and friction leads to increasing Mach numbers, divergence and centrifugal forces to decreasing Mach numbers. Sonic conditions should be avoided during the calculation. Especially if sonic conditions are observed at the end of a converged calculation, the result may not be correct.

Although the rotating pipe is adiabatic, i.e. no heat is transported to the environment, the total temperature changes due to conversion of rotational energy into heat or vice versa. Centrifugal motion leads to a total temperature increase, centripetal motion to a decrease. The change in total temperature amounts to [30]:

$$dT_t = \frac{r\omega^2}{c_p} dx. \quad (123)$$

For a linear varying radius integration leads to:

$$T_t - T_{t1} = \frac{\omega^2}{c_p} \left[r_1 + \left(\frac{r_2 - r_1}{2} \right) \frac{x}{L} \right] x. \quad (124)$$

Evaluating this expression for $x = L$ yields the total temperature increase across the pipe. In order to estimate the total pressure increase (e.g. to arrive at sensible initial conditions) one can again use the formulas in [30] (discarding the friction effect):

$$\frac{dp_t}{p_t} = \frac{\kappa}{\kappa - 1} \frac{r\omega^2}{c_p T_t} dx. \quad (125)$$

Substituting a linear relationship for r and the result just derived for T_t leads to:

$$\frac{dp_t}{p_t} = \left(\frac{\kappa}{\kappa - 1} \right) \frac{\omega^2}{c_p} \frac{[r_1 + (r_2 - r_1)x/L] dx}{\left\{ T_{t1} + \frac{\omega^2}{c_p} \left[r_1 + \left(\frac{r_2 - r_1}{2} \right) \frac{x}{L} \right] x \right\}} \quad (126)$$

$$= \left(\frac{\kappa}{\kappa - 1} \right) \frac{2 \left[x + \frac{Lr_1}{r_2 - r_1} \right] dx}{\left[x^2 + \frac{2Lr_1}{r_2 - r_1} x + \frac{2Lc_p T_{t1}}{\omega^2 (r_2 - r_1)} \right]} \quad (127)$$

$$= \left(\frac{\kappa}{\kappa - 1} \right) d \ln \left[x^2 + \frac{2Lr_1}{r_2 - r_1} x + \frac{2Lc_p T_{t1}}{\omega^2 (r_2 - r_1)} \right]. \quad (128)$$

Integrating finally leads to:

$$\frac{p_{t2}}{p_{t1}} = \left[1 + \frac{L\omega^2}{c_p T_{t1}} \left(\frac{r_1 + r_2}{2} \right) \right]^{\left(\frac{\kappa}{\kappa-1} \right)}. \quad (129)$$

It is important to notice that the rotating gas pipe is to be used in the relative (rotational) system (since the centrifugal force only exists in the rotational system). If used in the absolute system it has to be preceded by an absolute to relative element and followed by a relative to absolute element.

The rotating gas pipe is described by the following parameters (to be specified in that order on the line beneath the *FLUID SECTION, TYPE=ROTATING GAS PIPE card):

- A_1 : cross sectional area at node 1 (first node of element description)
- A_2 : cross sectional area at node 2 (third node of element description)
- L : length of the element
- k_s : grain diameter at the pipe surface
- form factor ϕ
- D_1 : diameter at node 1; if the form factor is 1 the diameter is calculated from the area using the formula for a circle.
- D_2 : diameter at node 2; if the form factor is 1 the diameter is calculated from the area using the formula for a circle.
- r_1 : distance from the rotational axis of node 1.
- r_2 : distance from the rotational axis of node 2.
- ω : rotational speed (in rad/s).

Example files: rotpipe1 up to rotpipe7.

6.4.9 Restrictor, Long Orifice

Properties: adiabatic, not isentropic, symmetric, A_1 inlet based restrictor

Restrictors are discontinuous geometry changes in gas pipes. The loss factor ζ can be defined based on the inlet conditions or the outlet conditions. Focusing on the h-s-diagram (enthalpy vs. entropy) Figure (92), the inlet conditions are denoted by the subscript 1, the outlet conditions by the subscript 2. The entropy loss from state 1 to state 2 is $s_2 - s_1$. The process is assumed to be adiabatic, i.e. $T_{t1} = T_{t2}$, and the same relationship applies to the total enthalpy h_t , denoted by a dashed line in the Figure. E_1 denotes the kinetic energy part of the enthalpy $v_1^2/2$, the same applies to E_2 . Now, the loss coefficient ζ based on the inlet conditions is defined by

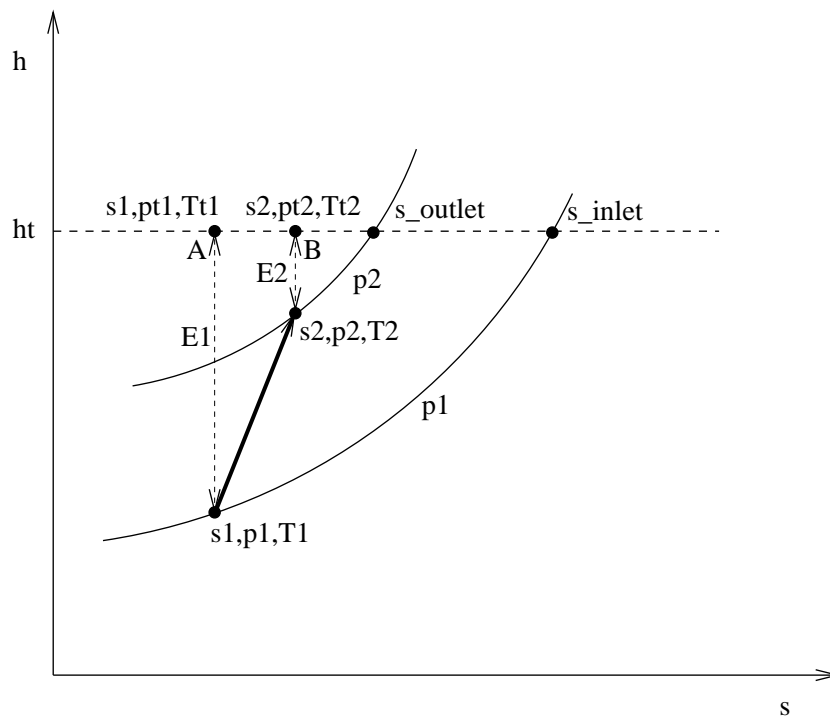
Figure 92: h - s diagram showing the restrictor process

$$\zeta_1 = \frac{s_2 - s_1}{s_{\text{inlet}} - s_1} \quad (130)$$

and based on the outlet conditions by

$$\zeta_2 = \frac{s_2 - s_1}{s_{\text{outlet}} - s_2}. \quad (131)$$

s_{inlet} is the entropy for zero velocity and isobaric conditions at the inlet, a similar definition applies to outlet. So, for ζ_1 the increase in entropy is compared with the maximum entropy increase from state 1 at isobaric conditions. Now we have $s_1 = s_A$ and $s_2 = s_B$ consequently,

$$\zeta_1 = \frac{s_B - s_A}{s_{\text{inlet}} - s_A} \quad (132)$$

and based on the outlet conditions by

$$\zeta_2 = \frac{s_B - s_A}{s_{\text{outlet}} - s_B}. \quad (133)$$

Using Equation (59) one obtains:

$$s_2 - s_1 = r \ln \frac{p_{t_1}}{p_{t_2}}, \quad (134)$$

$$s_{\text{inlet}} - s_1 = r \ln \frac{p_{t_1}}{p_1}, \quad (135)$$

$$s_{\text{outlet}} - s_2 = r \ln \frac{p_{t_2}}{p_2}, \quad (136)$$

from which [84]

$$\frac{p_{t_1}}{p_{t_2}} = \left(\frac{p_{t_1}}{p_1} \right)^{\zeta_1} = \left(1 + \frac{\kappa - 1}{2} M_1^2 \right)^{\zeta_1 \frac{\kappa}{\kappa - 1}} \quad (137)$$

if ζ is defined with reference to the first section (e.g. for an enlargement, a bend or an exit) and

$$\frac{p_{t_1}}{p_{t_2}} = \left(\frac{p_{t_2}}{p_2} \right)^{\zeta_2} = \left(1 + \frac{\kappa - 1}{2} M_2^2 \right)^{\zeta_2 \frac{\kappa}{\kappa - 1}}, \quad (138)$$

if ζ is defined with reference to the second section (e.g. for a contraction).

Using the general gas equation (45) finally leads to (for ζ_1):

$$\frac{\dot{m} \sqrt{r T_{t_1}}}{A p_{t_1} \sqrt{\kappa}} = \sqrt{\frac{2}{\kappa - 1} \left(\left(\frac{p_{t_1}}{p_{t_2}} \right)^{\frac{\kappa - 1}{\zeta_1 \kappa}} - 1 \right) \left(\frac{p_{t_1}}{p_{t_2}} \right)^{-\frac{(\kappa + 1)}{2 \zeta_1 \kappa}}}. \quad (139)$$

This equation reaches critical conditions (choking, $M_1 = 1$) for

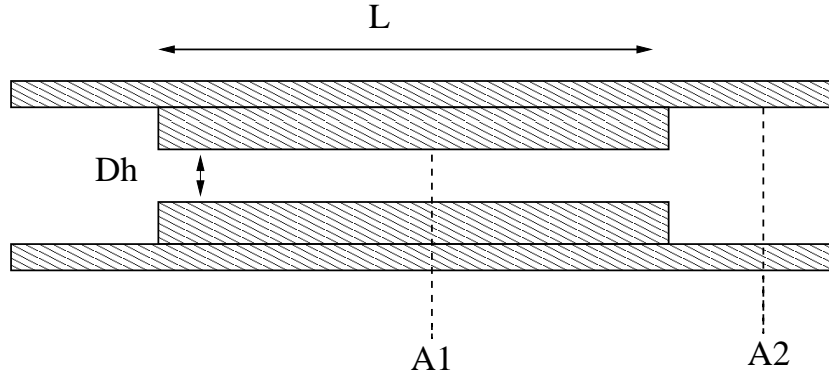

Figure 93: Geometry of a long orifice restrictor

$$\frac{p_{t_1}}{p_{t_2}} = \left(\frac{\kappa + 1}{2} \right)^{\zeta_1 \frac{\kappa}{\kappa-1}}. \quad (140)$$

Similar considerations apply to ζ_2 .

Restrictors can be applied to incompressible fluids as well by specifying the parameter LIQUID on the *FLUID SECTION card. In that case the pressure losses amount to

$$\Delta_1^2 F = \zeta \frac{\dot{m}^2}{2g\rho^2 A_1^2} \quad (141)$$

and

$$\Delta_1^2 F = \zeta \frac{\dot{m}^2}{2g\rho^2 A_2^2}, \quad (142)$$

respectively.

A long orifice is a substantial reduction of the cross section of the pipe over a significant distance (Figure 93).

There are two types: TYPE=RESTRICTOR LONG ORIFICE IDELCHIK with loss coefficients according to [38] and TYPE=RESTRICTOR LONG ORIFICE LICHTAROWICZ with coefficients taken from [50]. In both cases the long orifice is described by the following constants (to be specified in that order on the line beneath the *FLUID SECTION, TYPE=RESTRICTOR LONG ORIFICE IDELCHIK or TYPE=RESTRICTOR LONG ORIFICE LICHTAROWICZ card):

- reduced cross section A_1 .
- full cross section A_2 .
- hydraulic diameter D_h defined by $D_h = 4A/P$ where P is the perimeter of the cross section.

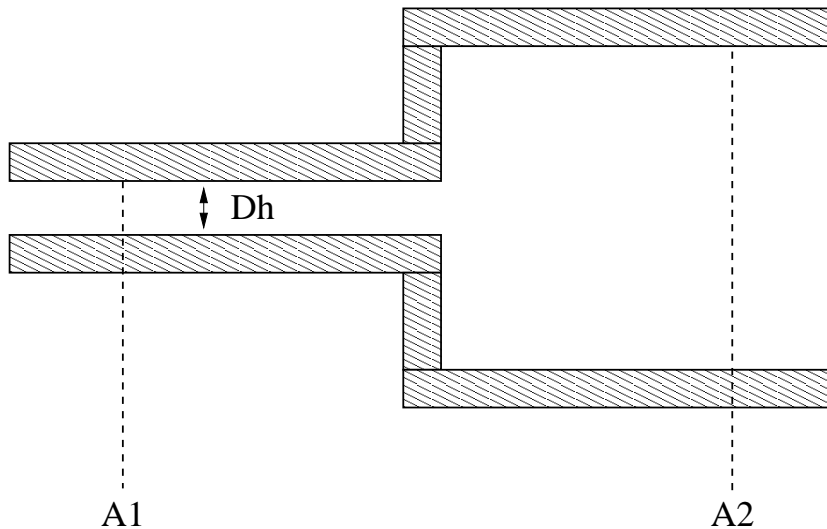

Figure 94: Geometry of an enlargement

- Length L of the orifice.
- oil mass flow in the restrictor (only if the OIL parameter is used to define the kind of oil in the *FLUID SECTION card)
- not used (internally: oil material number)

A restrictor of type long orifice MUST be preceded by a restrictor of type user with $\zeta = 0$. This accounts for the reduction of cross section from A_2 to A_1 .

By specifying the parameter LIQUID on the *FLUID SECTION card the loss is calculated for liquids. In the absence of this parameter, compressible losses are calculated.

Example files: restrictor, restrictor-oil.

6.4.10 Restrictor, Enlargement

Properties: adiabatic, not isentropic, directional, inlet based restrictor

The geometry of an enlargement is shown in Figure 94. It is described by the following constants (to be specified in that order on the line beneath the *FLUID SECTION, TYPE=RESTRICTOR ENLARGEMENT card):

- reduced cross section A_1 .
- full cross section A_2 .
- hydraulic diameter D_h of the reduced cross section defined by $D_h = 4A/P$ where P is the perimeter of the cross section.

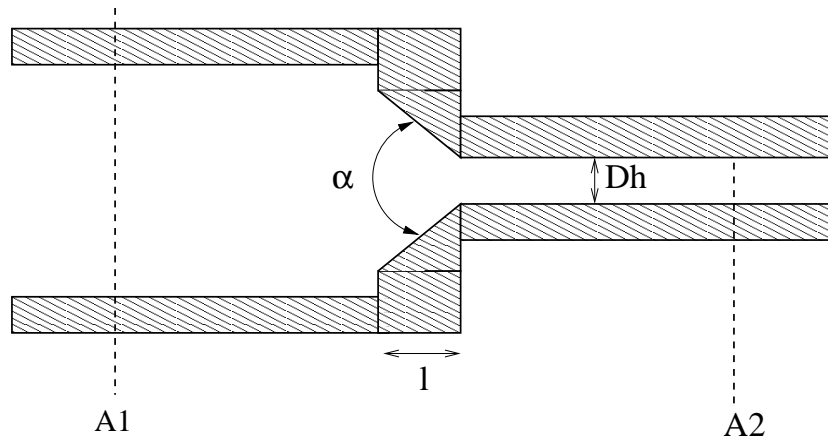

Figure 95: Geometry of a contraction

- oil mass flow in the restrictor (only if the OIL parameter is used to define the kind of oil in the *FLUID SECTION card)
- not used (internally: oil material number)

The loss coefficient for an enlargement is taken from [38].

By specifying the parameter LIQUID on the *FLUID SECTION card the loss is calculated for liquids. In the absence of this parameter, compressible losses are calculated.

Example files: piperestrictor, restrictor, restrictor-oil.

6.4.11 Restrictor, Contraction

Properties: adiabatic, not isentropic, directional, outlet based restrictor

The geometry of a contraction is shown in Figure 95. It is described by the following constants (to be specified in that order on the line beneath the *FLUID SECTION, TYPE=RESTRICTOR CONTRACTION card):

- full cross section A_1 .
- reduced cross section A_2 .
- hydraulic diameter D_h of the reduced cross section defined by $D_h = 4A/P$ where P is the perimeter of the cross section.
- chamfer length L .
- chamfer angle α ($^\circ$).
- oil mass flow in the restrictor (only if the OIL parameter is used to define the kind of oil in the *FLUID SECTION card)

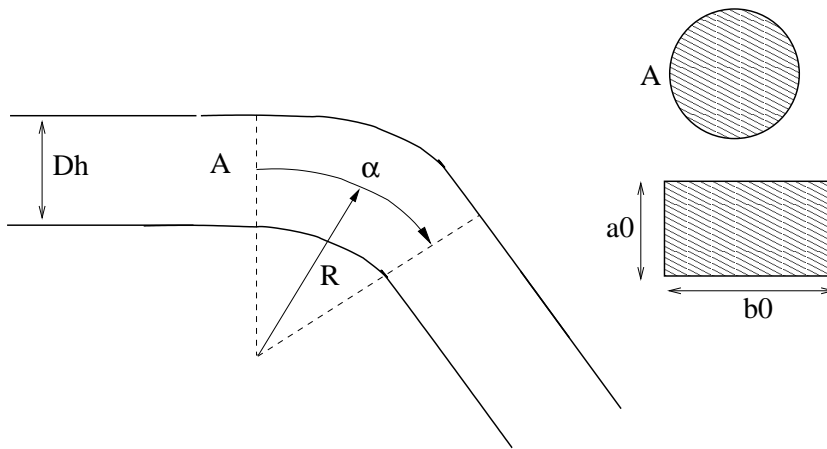

Figure 96: Geometry of a bend

- not used (internally: oil material number)

The loss coefficient for a contraction is taken from [38].

By specifying the parameter LIQUID on the *FLUID SECTION card the loss is calculated for liquids. In the absence of this parameter, compressible losses are calculated.

Example files: piperestrictor, restrictor, restrictor-oil.

6.4.12 Restrictor, Bend

Properties: adiabatic, not isentropic, symmetric, inlet based restrictor

The geometry of a bend is shown in Figure 96. There are three types: TYPE = RESTRICTOR BEND IDEL CIRC, TYPE = RESTRICTOR BEND IDEL RECT, both with loss coefficients according to [38] and TYPE = RESTRICTOR BEND MILLER with coefficients taken from [61]. In the first and last type the bend is described by the following constants (to be specified in that order on the line beneath the *FLUID SECTION, TYPE = RESTRICTOR BEND IDEL CIRC or TYPE = RESTRICTOR BEND MILLER card):

- cross section before the bend A .
- cross section after the bend A .
- hydraulic diameter $D_h = 4A/P$, where P is the perimeter of the cross section.
- radius of the bend R .
- bend angle α ($^\circ$).

- oil mass flow in the restrictor (only if the OIL parameter is used to define the kind of oil in the *FLUID SECTION card)
- not used (internally: oil material number)

They apply to circular cross sections. For rectangular cross sections the constants are as follows (to be specified in that order on the line beneath the *FLUID SECTION, TYPE=RESTRICTOR BEND IDEL RECT card):

- cross section before the bend A .
- cross section after the bend A .
- hydraulic diameter $D_h = 4A/P$, where P is the perimeter of the cross section.
- radius of the bend R .
- bend angle α .
- height a_0 .
- width b_0 .
- oil mass flow in the restrictor (only if the OIL parameter is used to define the kind of oil in the *FLUID SECTION card)
- not used (internally: oil material number)

The loss coefficients are those published by Idelchik [38] and Miller [61].

By specifying the parameter LIQUID on the *FLUID SECTION card the loss is calculated for liquids. In the absence of this parameter, compressible losses are calculated.

Example files: restrictor, restrictor-oil.

6.4.13 Restrictor, Wall Orifice

Properties: adiabatic, not isentropic, directional, A -outlet based restrictor

The geometry of an wall orifice is shown in Figure 97. It is described by the following constants (to be specified in that order on the line beneath the *FLUID SECTION, TYPE=RESTRICTOR WALL ORIFICE card):

- not used (internally: set to 100,000 A as upstream section)
- reduced cross section A .
- hydraulic diameter D_h defined by $D_h = 4A/P$ where P is the perimeter of the cross section.
- length L

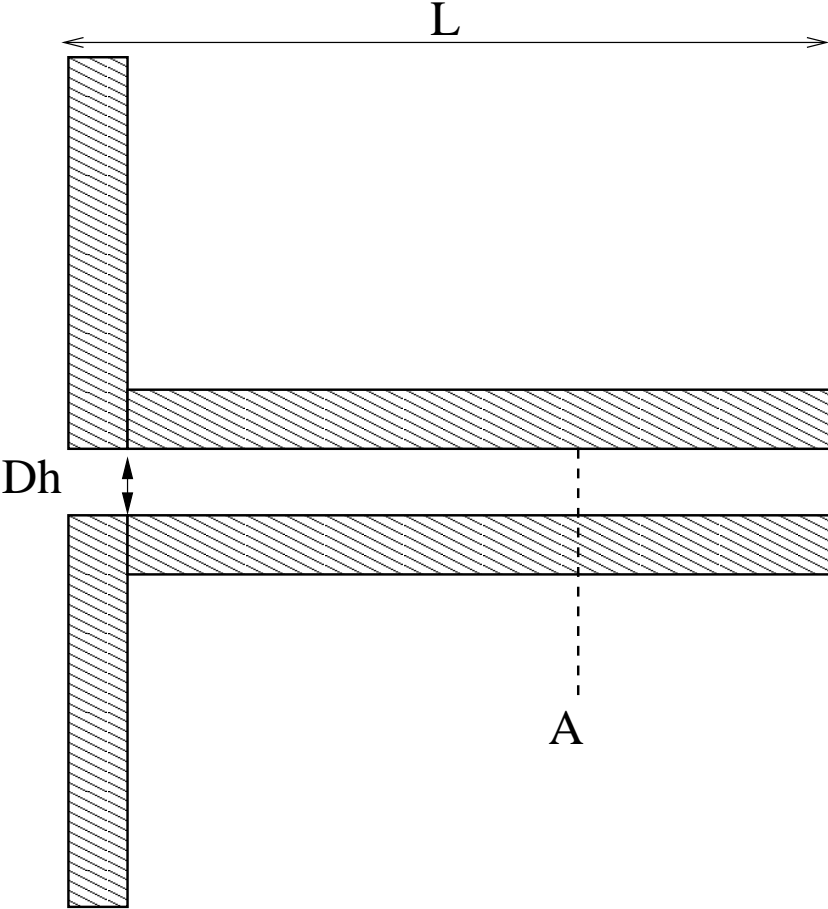

Figure 97: Geometry of a wall orifice

- oil mass flow in the restrictor (only if the OIL parameter is used to define the kind of oil in the *FLUID SECTION card)
- not used (internally: oil material number)

The loss coefficient for a wall orifice is taken from [38].

By specifying the parameter LIQUID on the *FLUID SECTION card the loss is calculated for liquids. In the absence of this parameter, compressible losses are calculated.

6.4.14 Restrictor, Entrance

Properties: adiabatic, not isentropic, directional, A -outlet based restrictor

An entrance element is used to model the entry from a large chamber into a gas pipe. For an entrance the value of ζ is 0.5. It is described by the following constants (to be specified in that order on the line beneath the *FLUID SECTION, TYPE=RESTRICTOR ENTRANCE card):

- not used (internally: set to 100,000 A as upstream section)
- cross section of the entrance A .
- hydraulic diameter D_h defined by $D_h = 4A/P$ where P is the perimeter of the cross section.
- not used (internally: set of 0.5 as pressure loss coefficient)
- oil mass flow in the restrictor (only if the OIL parameter is used to define the kind of oil in the *FLUID SECTION card)
- not used (internally: oil material number)

By specifying the parameter LIQUID on the *FLUID SECTION card the loss is calculated for liquids. In the absence of this parameter, compressible losses are calculated.

6.4.15 Restrictor, Exit

Properties: adiabatic, not isentropic, directional, A -inlet based restrictor

An exit element is used to model the exit from a gas pipe into a large chamber. For an exit the value of ζ is 1. It is described by the following constants (to be specified in that order on the line beneath the *FLUID SECTION, TYPE=RESTRICTOR EXIT card):

- cross section of the exit A .
- not used (internally: set to 100,000 A as downstream section)
- hydraulic diameter D_h defined by $D_h = 4A/P$ where P is the perimeter of the cross section.

- number of the upstream element; this element must be of type GAS PIPE FANNO
- oil mass flow in the restrictor (only if the OIL parameter is used to define the kind of oil in the *FLUID SECTION card)
- not used (internally: oil material number)

By specifying the parameter LIQUID on the *FLUID SECTION card the loss is calculated for liquids. In the absence of this parameter, compressible losses are calculated.

6.4.16 Restrictor, User

Properties: adiabatic, not isentropic, directional, inlet based restrictor if $A_1 < A_2$ and outlet based restrictor if $A_2 < A_1$.

A user-defined restrictor is described by the following constants (to be specified in that order on the line beneath the *FLUID SECTION, TYPE=RESTRICTOR USER card):

- upstream cross section A_1 .
- downstream cross section A_2 .
- hydraulic diameter D_h defined by $D_h = 4A/P$ where A is the area of the smallest cross section and P is the perimeter of the smallest cross section.
- loss coefficient ζ .
- oil mass flow in the restrictor (only if the OIL parameter is used to define the kind of oil in the *FLUID SECTION card)
- not used (internally: oil material number)

By specifying the parameter LIQUID on the *FLUID SECTION card the loss is calculated for liquids. In the absence of this parameter, compressible losses are calculated.

Example files: restrictor, restrictor-oil.

6.4.17 Branch, Joint

Properties: adiabatic, not isentropic, directional, inlet based restrictor

In a joint the flow from two gas pipes is united and redirected through a third pipe. So in principal three network elements of type GAS PIPE have one node in common in a joint. The fluid elements of type BRANCH JOINT represent the extra energy loss due to the merging of the flows and have to be inserted on the incoming branches of the joint. This is represented schematically in Figure 98. The filled circles represent end nodes of the fluid elements, the others are

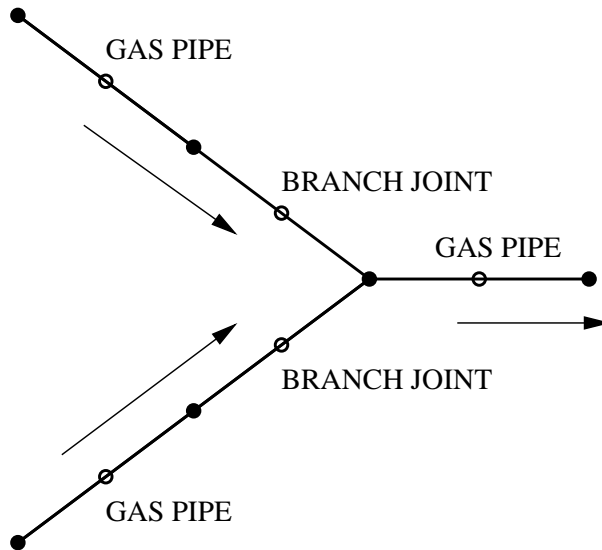

Figure 98: Element selection for a joint

the midside nodes. For a joint to work properly the flow direction must be as indicated in Figure 98. If the solution of the equation system indicates that this is not the case appropriate measures must be taken. For instance, if the solution reveals that there is one inward flow and two outward flows, branch split elements must be selected.

Several types of geometry are available.

A branch joint of type GE [102], Figure 99, is quite general and allows arbitrary cross sections and angles (within reasonable limits). It is characterized by the following constants (to be specified in that order on the line beneath the *FLUID SECTION, TYPE=BRANCH JOINT GE card):

- label of the gas pipe element defined as branch 0.
- label of the gas pipe element defined as branch 1.
- label of the gas pipe element defined as branch 2.
- cross section A_0 of branch 0.
- cross section A_1 of branch 1.
- cross section A_2 of branch 2.
- angle α_1 ($^\circ$).
- angle α_2 ($^\circ$).
- oil mass flow in branch 1 (only if the OIL parameter is used to define the kind of oil in the *FLUID SECTION card)

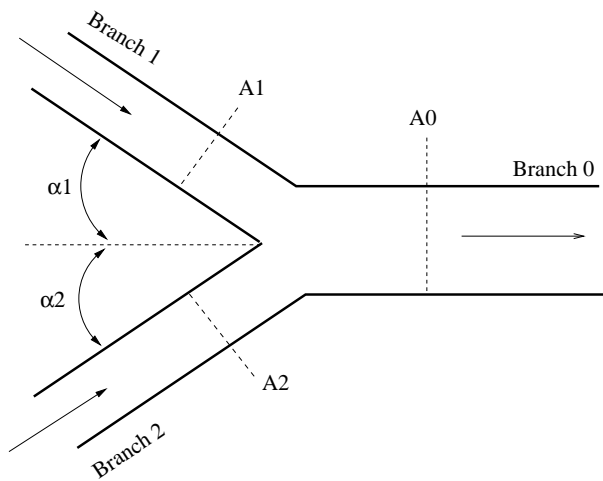

Figure 99: Geometry of a joint fluid section type GE

- oil mass flow in branch 2 (only if the OIL parameter is used to define the kind of oil in the *FLUID SECTION card)
- not used (internally: oil material number)

A branch joint of type Idelchik1, Figure 100, can be used if one of the incoming branches is continued in a straight way and does not change its cross section [38]. It is characterized by the following constants (to be specified in that order on the line beneath the *FLUID SECTION, TYPE=BRANCH JOINT IDELCHIK1 card):

- label of the gas pipe element defined as branch 0.
- label of the gas pipe element defined as branch 1.
- label of the gas pipe element defined as branch 2.
- cross section A_0 of branch 0.
- cross section $A_1 = A_0$ of branch 0.
- cross section A_2 of branch 2.
- angle $\alpha_1 = 0^\circ$.
- angle α_2 ($^\circ$).
- oil mass flow in branch 1 (only if the OIL parameter is used to define the kind of oil in the *FLUID SECTION card)
- oil mass flow in branch 2 (only if the OIL parameter is used to define the kind of oil in the *FLUID SECTION card)

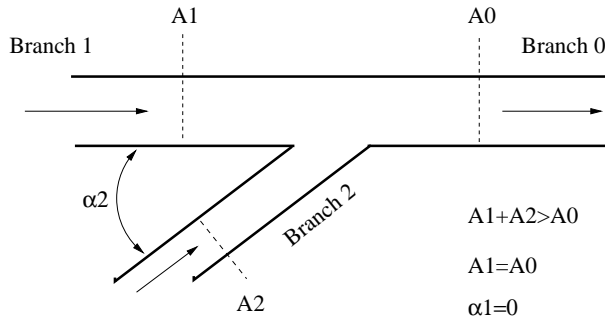

Figure 100: Geometry of a joint fluid section type Idelchik 1

- not used (internally: oil material number)

A branch joint of type Idelchik2, Figure 101, can be used if one of the incoming branches is continued in a straight way but may change its cross section [38]. It is characterized by the following constants (to be specified in that order on the line beneath the *FLUID SECTION, TYPE=BRANCH JOINT IDELCHIK2 card):

- label of the gas pipe element defined as branch 0.
- label of the gas pipe element defined as branch 1.
- label of the gas pipe element defined as branch 2.
- cross section A_0 of branch 0.
- cross section A_1 of branch 1.
- cross section A_2 of branch 2.
- angle $\alpha_1 = 0^\circ$.
- angle α_2 ($^\circ$).
- oil mass flow in branch 1 (only if the OIL parameter is used to define the kind of oil in the *FLUID SECTION card)
- oil mass flow in branch 2 (only if the OIL parameter is used to define the kind of oil in the *FLUID SECTION card)
- not used (internally: oil material number)

By specifying the parameter LIQUID on the *FLUID SECTION card the loss is calculated for liquids. In the absence of this parameter, compressible losses are calculated.

Example files: branchjoint1, branchjoint2, branchjoint3, branchjoint4.

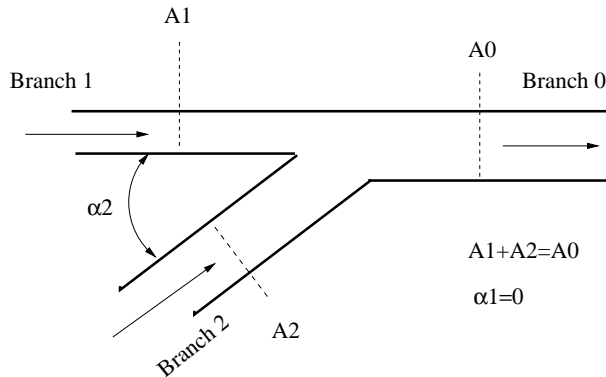

Figure 101: Geometry of a joint fluid section type Idelchik 2

6.4.18 Branch, Split

Properties: adiabatic, not isentropic, directional, inlet based restrictor

In a split the flow from a gas pipe is split and redirected through two other pipes. So in principal three network elements of type GAS PIPE have one node in common in a split. The fluid elements of type BRANCH SPLIT represent the extra energy loss due to the splitting of the flow and have to be inserted in the outward branches of the split. This is represented schematically in Figure 102. The filled circles represent end nodes of the fluid elements, the others are the midside nodes. For a split to work properly the flow direction must be as indicated in Figure 102. If the solution of the equation system indicates that this is not the case appropriate measures must be taken. For instance, if the solution reveals that there are two inward flows and one outward flow, branch joint elements must be selected.

Several types of geometry are available.

A branch split of type GE [102], Figure 103, is quite general and allows arbitrary cross sections and angles (within reasonable limits). It is characterized by the following constants (to be specified in that order on the line beneath the *FLUID SECTION, TYPE=BRANCH SPLIT GE card):

- label of the gas pipe element defined as branch 0.
- label of the gas pipe element defined as branch 1.
- label of the gas pipe element defined as branch 2.
- cross section A_0 of branch 0.
- cross section A_1 of branch 1.
- cross section A_2 of branch 2.
- angle α_1 ($^\circ$).

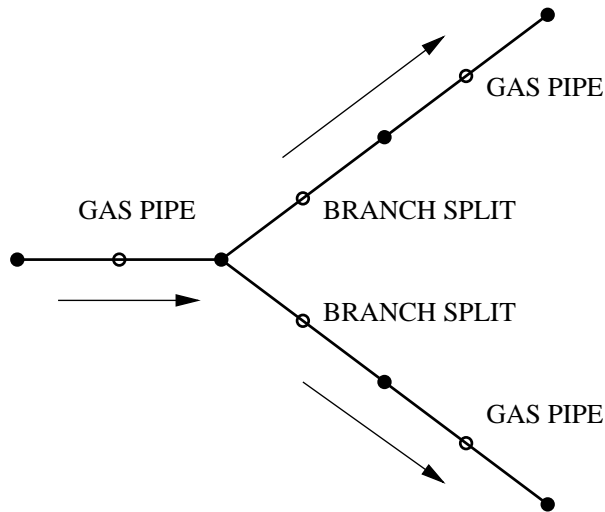

Figure 102: Element selection for a split

- angle α_2 ($^\circ$).
- oil mass flow in branch 1 (only if the OIL parameter is used to define the kind of oil in the *FLUID SECTION card)
- oil mass flow in branch 2 (only if the OIL parameter is used to define the kind of oil in the *FLUID SECTION card)
- not used (internally: oil material number)

A branch split of type Idelchik1, Figure 104, can be used if the incoming branch is continued in a straight way and does not change its cross section [38]. It is characterized by the following constants (to be specified in that order on the line beneath the *FLUID SECTION, TYPE=BRANCH SPLIT IDELCHIK1 card):

- label of the gas pipe element defined as branch 0.
- label of the gas pipe element defined as branch 1.
- label of the gas pipe element defined as branch 2.
- cross section A_0 of branch 0.
- cross section $A_1 = A_0$ of branch 0.
- cross section A_2 of branch 2.
- angle $\alpha_1 = 0^\circ$.

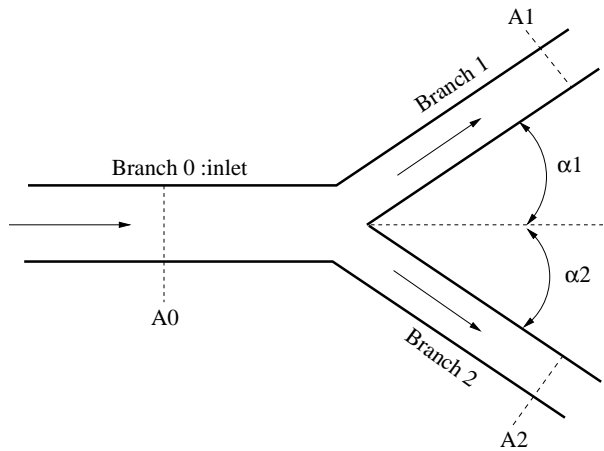

Figure 103: Geometry of a split fluid section type GE

- angle α_2 ($^\circ$).
- hydraulic diameter D_{h0} of A_0 .
- hydraulic diameter D_{h2} of A_2 .
- oil mass flow in branch 1 (only if the OIL parameter is used to define the kind of oil in the *FLUID SECTION card)
- oil mass flow in branch 2 (only if the OIL parameter is used to define the kind of oil in the *FLUID SECTION card)
- ζ -correction factor k_1 for branch 1 ($\zeta_{eff} = k_1\zeta$). This allows to tune the ζ value with experimental evidence (default is 1).
- ζ -correction factor k_2 for branch 2 ($\zeta_{eff} = k_2\zeta$). This allows to tune the ζ value with experimental evidence (default is 1).
- not used (internally: oil material number)

A branch split of type Idelchik2, Figure 105, is used if the outward branches make an angle of 90° with the incoming branch [38]. It is characterized by the following constants (to be specified in that order on the line beneath the *FLUID SECTION, TYPE=BRANCH SPLIT IDELCHIK2 card):

- label of the gas pipe element defined as branch 0.
- label of the gas pipe element defined as branch 1.
- label of the gas pipe element defined as branch 2.
- cross section A_0 of branch 0.

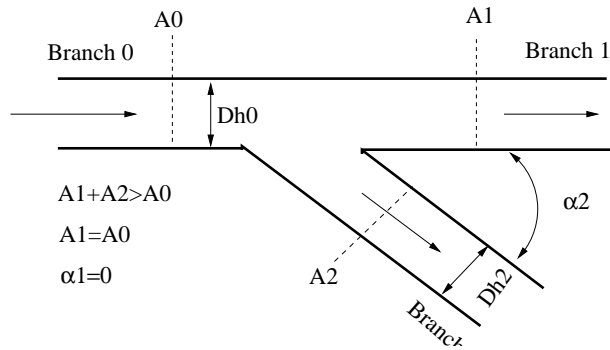

Figure 104: Geometry of a split fluid section type Idelchik 1

- cross section A_1 of branch 1.
- cross section A_2 of branch 2.
- angle $\alpha_1 = 90^\circ$.
- angle $\alpha_2 = 90^\circ$.
- oil mass flow in branch 1 (only if the OIL parameter is used to define the kind of oil in the *FLUID SECTION card)
- oil mass flow in branch 2 (only if the OIL parameter is used to define the kind of oil in the *FLUID SECTION card)
- ζ -correction factor k_1 for branch 1 ($\zeta_{eff} = k_1\zeta$). This allows to tune the ζ value with experimental evidence (default is 1).
- ζ -correction factor k_2 for branch 2 ($\zeta_{eff} = k_2\zeta$). This allows to tune the ζ value with experimental evidence (default is 1).
- not used (internally: oil material number)

By specifying the parameter LIQUID on the *FLUID SECTION card the loss is calculated for liquids. In the absence of this parameter, compressible losses are calculated.

Example files: branchsplit1, branchsplit2, branchsplit3.

6.4.19 Cross, Split

Properties: adiabatic, not isentropic, directional, inlet based restrictor

This is an element, in which a gas mass flow is split into three separate branches. (See Fig.106) It is characterized by the following constants (to be specified in that order on the line beneath the *FLUID SECTION, TYPE=CROSS SPLIT card):

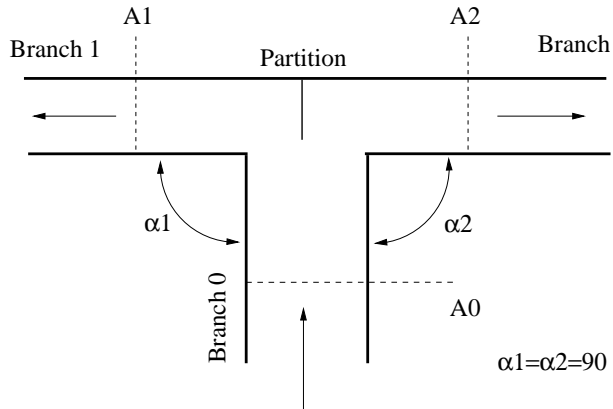

Figure 105: Geometry of a split fluid section type Idelchik 2

- label of the element defined as branch 0.
- label of the element defined as branch 1.
- label of the element defined as branch 2.
- label of the element defined as branch 3.
- cross section A_0 of branch 0, whereas $A_1 = A_0$
- cross section A_2 of branch 2, whereas $A_3 = A_2$
- angle $\alpha_1 = 90^\circ$.
- angle $\alpha_2 = 90^\circ$.
- hydraulic diameter $d_{h0} = d_{h1}$
- hydraulic diameter $d_{h2} = d_{h3}$
- ζ -correction factor k_1 for the main passage ($\zeta_{eff} = k_1\zeta$)
- ζ -correction factor k_2 for the branches ($\zeta_{eff} = k_2\zeta$)

6.4.20 Vortex

Properties: adiabatic, isentropic, asymmetric

A vortex arises, when a gas flows along a rotating device. If the inertia of the gas is small and the device rotates at a high speed, the device will transfer part of its rotational energy to the gas. This is called a forced vortex. It is characterized by an increasing circumferential velocity for increasing values of the radius, Figure 107.

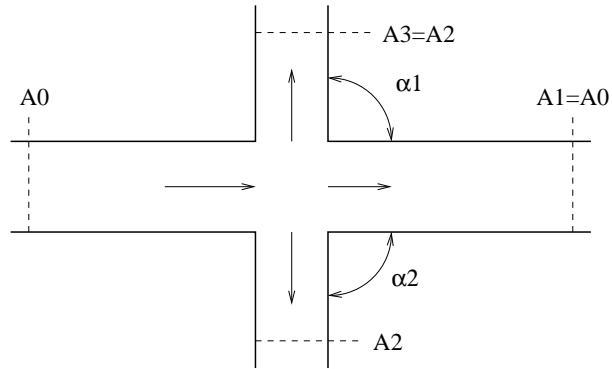

Figure 106: Geometry of a flow splitting cross

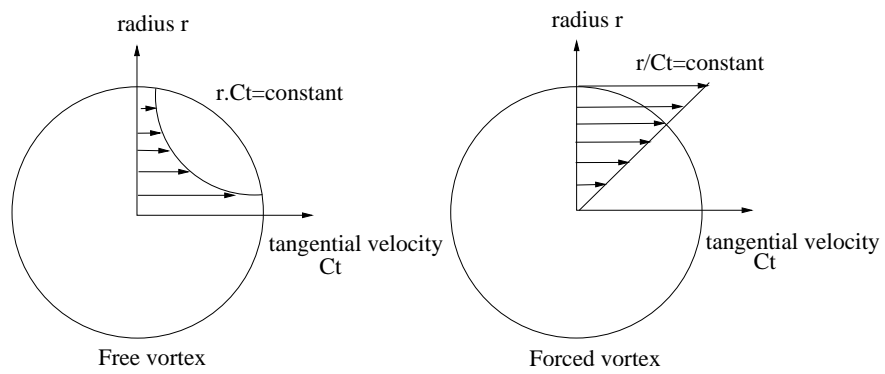

Figure 107: Forced vortex versus free vortex

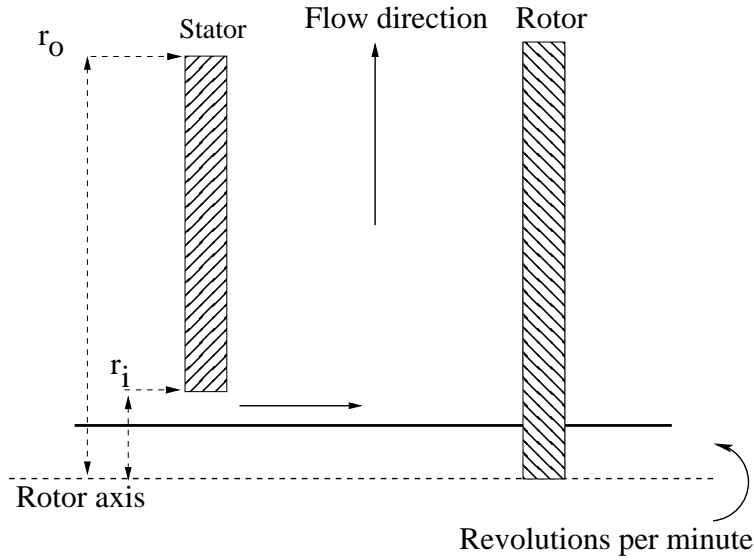

Figure 108: Geometry of a forced vortex

Another case is represented by a gas exhibiting substantial swirl at a given radius and losing this swirl while flowing away from the axis. This is called a free vortex and is characterized by a hyperbolic decrease of the circumferential velocity, Figure 107. The initial swirl usually comes from a preceding rotational device.

The equations for the forced and free vortex are derived from:

- The radial equilibrium of an infinitesimal volumetric element of size $rd\varphi \times dr$ subject to a pressure on all sides of the form $p(r)$ and centrifugal loading for which $\omega = C_t/r$, where C_t is the local circumferential velocity. This leads to the equation

$$\frac{1}{\rho} \frac{\partial p}{\partial r} = \frac{C_t^2}{r}. \quad (143)$$

$v_r \ll C_t$ is assumed, i.e. the radial velocity is negligible w.r.t. the tangential velocity.

- the assumption that the flow is isentropic, i.e.

$$\frac{p}{\rho^\kappa} = \text{constant}, \quad (144)$$

e.g. equal to the value at the inner or outer position.

- the assumption that the flow is adiabatic (T_t is constant).

- the assumption that the upstream and downstream nodes correspond to big reservoirs, consequently the total and static pressure as well as the total and static temperature coincide.

Integrating the differential equation (143) from r_i to r_o (after substitution of the isentropic assumption and separation of the variables p and r ; the index “i” stands for inner (smallest radius), “o” stands for outer (largest radius)) leads to

$$\frac{p_{t_o}}{p_{t_i}} = \left[1 + \frac{1}{c_p T_{t_i}} \int_{r_i}^{r_o} \frac{C_t^2}{r} dr \right]^{\frac{\kappa}{\kappa-1}}. \quad (145)$$

The forced vortex, Figure 108, is geometrically characterized by its upstream and downstream radius. The direction of the flow can be centripetal or centrifugal, the element formulation works for both. The core swirl ratio K_r , which takes values between 0 and 1, denotes the degree the gas rotates with the rotational device. If $K_r = 0$ there is no transfer of rotational energy, if $K_r = 1$ the gas rotates with the device. The theoretical pressure ratio across a forced vortex satisfies (substitute $C_t = K_r C_{t_i} r / r_i$ in Equation (145))

$$\left(\frac{p_{t_o}}{p_{t_i}} \right)_{theoretical} = \left[1 + \frac{(K_r C_{t_i})^2}{2c_p T_{t_i}} \left(\left(\frac{r_o}{r_i} \right)^2 - 1 \right) \right]^{\frac{\kappa}{\kappa-1}}, \quad (146)$$

where p_t is the total pressure, T_t the total temperature and C_{t_i} the circumferential velocity of the rotating device. It can be derived from the observation that the circumferential velocity of the gas varies linear with the radius (Figure 107). Notice that the pressure at the outer radius always exceeds the pressure at the inner radius, no matter in which direction the flow occurs.

The pressure correction factor η allows for a correction to the theoretical pressure drop across the vortex and is defined by

$$\eta = \frac{\Delta p_{real}}{\Delta p_{theoretical}}, \Delta p = \frac{p_{t_o} - p_{t_i}}{p_{t_i}}. \quad (147)$$

Finally, the parameter T_{flag} controls the temperature increase due to the vortex. In principal, the rotational energy transferred to the gas also leads to a temperature increase. If the user does not want to take that into account $T_{flag} = 0$ should be selected, else $T_{flag} = 1$ or $T_{flag} = -1$ should be specified, depending on whether the vortex is defined in the absolute coordinate system or in a relative system fixed to the rotating device, respectively. A relative coordinate system is active if the vortex element is at some point in the network preceded by an absolute-to-relative gas element and followed by a relative-to-absolute gas element. The calculated temperature increase is only correct for $K_r = 1$. Summarizing, a forced vortex element is characterized by the following constants (to be specified in that order on the line beneath the *FLUID SECTION, TYPE=VORTEX FORCED card):

- r_2 : radius corresponding to the third node in the topology of the vortex element

- r_1 : radius corresponding to the first node in the topology of the vortex element
- η : pressure correction factor
- K_r : core swirl ratio
- N : speed of the rotating device (rad/unit of time)
- T_{flag}
- not used (internally: circumferential exit velocity in unit of length/unit of time (for the downstream element))

For the free vortex the value of the circumferential velocity C_t of the gas at entrance is the most important parameter. It can be defined by specifying the number n of the preceding element, usually a preswirl nozzle or another vortex, imparting the circumferential velocity. In that case the value N is not used. For centrifugal flow the value of the imparted circumferential velocity $C_{t,theoretical,i}$ can be further modified by the swirl loss factor K_1 defined by

$$K_1 = \frac{C_{t,real,i} - U_i}{C_{t,theoretical,i} - U_i}. \quad (148)$$

Alternatively, if the user specifies $n = 0$, the circumferential velocity at entrance is taken from the rotational speed N of a device imparting the swirl to the gas. In that case K_1 and U_i are not used and $C_{t,real,i} = Nr_i$. The theoretical pressure ratio across a free vortex satisfies (substitute $C_t = C_{t,real,i}r_i/r$ in Equation (145))

$$\left(\frac{p_{t_o}}{p_{t_i}}\right)_{theoretical} = \left[1 + \frac{C_{t,real,i}^2}{2c_p T_{t_i}} \left(1 - \left(\frac{r_i}{r_o}\right)^2\right)\right]^{\frac{\kappa}{\kappa-1}}, \quad (149)$$

where p_t is the total pressure, T_t the total temperature and C_t the circumferential velocity of the gas. It can be derived from the observation that the circumferential velocity of the gas varies inversely proportional to the radius (Figure 107). Notice that the pressure at the outer radius always exceeds the pressure at the inner radius, no matter in which direction the flow occurs.

Here too, the pressure can be corrected by a pressure correction factor η and a parameter T_{flag} is introduced to control the way the temperature change is taken into account. However, it should be noted that for a free vortex the temperature does not change in the absolute system. Summarizing, a free vortex element is characterized by the following constants (to be specified in that order on the line beneath the *FLUID SECTION, TYPE=VORTEX FREE card):

- r_2 : radius corresponding to the third node in the topology of the vortex element
- r_1 : radius corresponding to the first node in the topology of the vortex element

- η : pressure correction factor
- K_1 : swirl loss factor (only if $n \neq 0$ and $N = 0$)
- U_i : circumferential velocity of the rotating device at the upstream radius (only if $n \neq 0$ and $N = 0$)
- n : number of the gas element responsible for the swirl (mutually exclusive with N)
- N : speed of the rotating device (rad/unit of time, mutually exclusive with n ; if both n and N are nonzero, N takes precedence)
- T_{flag}
- not used (internally: circumferential exit velocity in unit of length/unit of time (for the downstream element))

By specifying the parameter LIQUID on the *FLUID SECTION card the loss is calculated for liquids. In the absence of this parameter, compressible losses are calculated.

Example files: vortex1, vortex2, vortex3.

6.4.21 Möhring

A Möhring element is a vortex element for which the characteristics are determined by the integration of a nonlinear differential equation describing the physics of the problem [64]. It basically describes the flow in narrow gaps between a rotating and a static device and is more precise than the formulation of the forced and free vortex element. The geometry is shown in Figure 109 and consists of a minimum radius, a maximum radius, a value for the gap between stator and rotor and the shroud radius. It is complemented by the label of the upstream and downstream node, the rotating speed of the rotor and the value of the swirl at entrance. The user must choose the centrifugal or centripetal version of the Moehring element before start of the calculation, i.e. the user must decide beforehand in which direction the flow will move. If the calculation detects that the flow is reversed, an error message is issued.

The following constants must be entered (to be specified in that order on the line beneath the *FLUID SECTION, TYPE=MOEHRING CENTRIFUGAL card or *FLUID SECTION, TYPE=MOEHRING CENTRIPETAL card):

- R_{min} : minimum radius
- R_{max} : maximum radius
- d : disk/stator gap
- R_{shroud} : shroud radius

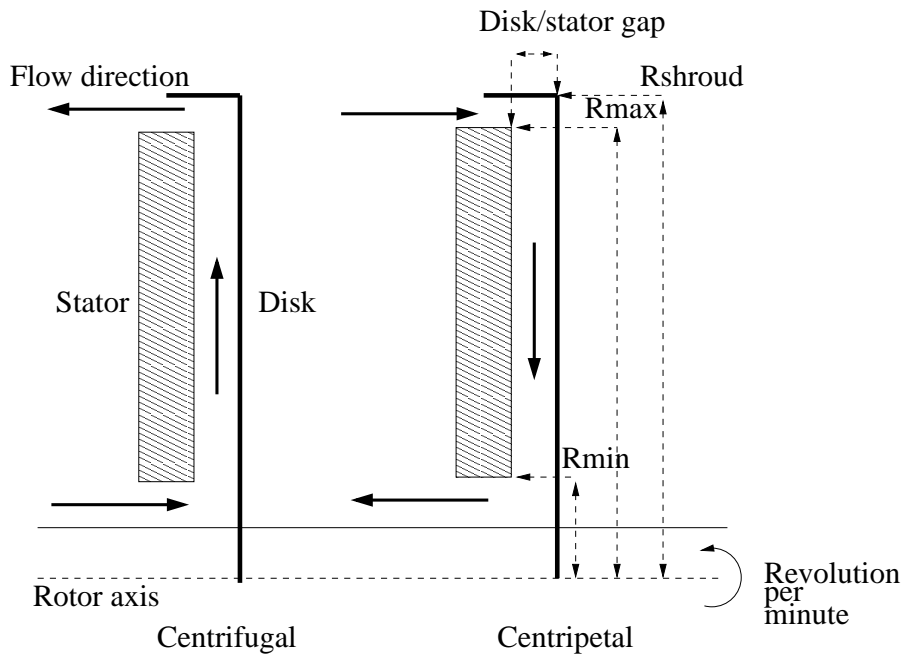

Figure 109: Geometry of the Möhring element

- upstream node label
- downstream node label
- N : speed of the rotor (rad/unit of time)
- circumferential speed of the gas at entrance
- alternatively to the previous line, the upstream element number
- not used (internally: circumferential exit velocity in unit of length/unit of time (for the downstream element))

Example files: moehring.

6.4.22 Change absolute/relative system

Sometimes it is more convenient to work in a relative system fixed to some rotating device, e.g. to model the flow through holes in a rotating disk. In order to facilitate this, two conversion elements were created: a relative-to-absolute element and an absolute-to-relative element. The transformation takes place at a given radius and the element has a physical length of zero. Input for this element is the circumferential velocity of the rotating device and the

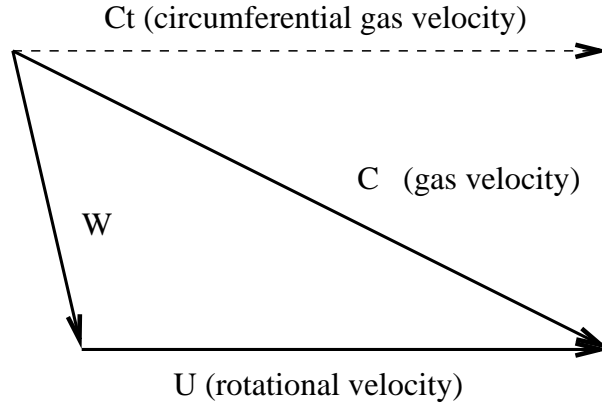

Figure 110: Vector plot of the absolute/relative velocity

tangential gas velocity, both at the radius at which the transformation is to take place. The gas velocity can be specified explicitly, or by referring to an element immediately preceding the transformation location and imparting a specific swirl to the gas.

Let U be the circumferential velocity of the rotating device at the selected radius, C the velocity of the gas at the same location and C_t its circumferential component (Figure 110). The velocity of the gas W in the rotating system satisfies:

$$\mathbf{W} = \mathbf{C} - \mathbf{U}. \quad (150)$$

The total temperature in the absolute system is

$$T_t = T + \frac{C^2}{2c_p}, \quad (151)$$

whereas in the relative system it amounts to

$$T_{tr} = T + \frac{W^2}{2c_p}. \quad (152)$$

Combining these equations and using the relationship between the length of the sides of an irregular triangle (cosine rule) one arrives at:

$$T_{tr} = T_t \left(1 + \frac{U^2 - 2UC_t}{2c_p T_t} \right). \quad (153)$$

Assuming adiabatic conditions this leads for the pressure to:

$$p_{tr} = p_t \left(1 + \frac{U^2 - 2UC_t}{2c_p T_t} \right)^{\frac{\kappa}{\kappa-1}}. \quad (154)$$

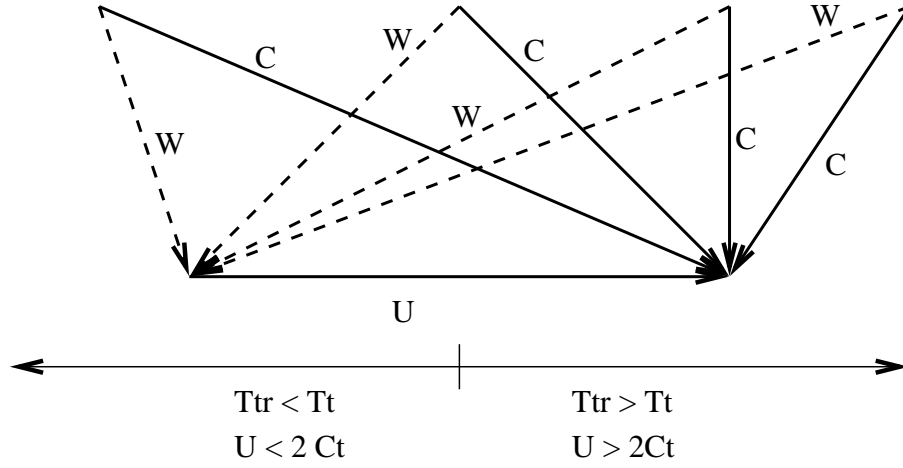

Figure 111: Total temperature dependence on the circumferential component of the incoming flow

Depending on the size of $2C_t$ compared to the size of U the relative total temperature will exceed the absolute total temperature or vice versa. This is illustrated in Figure 111.

Inversely, the relationships for the relative-to-absolute transformation amount to:

$$T_t = T_{tr} \left(1 - \frac{U^2 - 2UC_t}{2c_p T_{tr}} \right). \quad (155)$$

and:

$$p_t = p_{tr} \left(1 - \frac{U^2 - 2UC_t}{2c_p T_{tr}} \right)^{\frac{\kappa}{\kappa-1}}. \quad (156)$$

These relationships are taken into account in the following way: the change in total temperature is taken care of by creating a heat inflow at the downstream node. For an absolute-to-relative change this heat flow amounts to:

$$c_p(T_{tr} - T_t)\dot{m} = \frac{U^2 - 2UC_t}{2}\dot{m}. \quad (157)$$

The total pressure change is taken as element equation. For an absolute-to-relative change it runs:

$$\frac{p_{t_{\text{out}}}}{p_{t_{\text{in}}}} - \left(1 + \frac{U^2 - 2UC_t}{2c_p T_{t_{\text{in}}}} \right)^{\frac{\kappa}{\kappa-1}} = 0, \quad (158)$$

and for a relative-to-absolute change:

$$\frac{p_{t_{\text{out}}}}{p_{t_{\text{in}}}} - \left(1 - \frac{U^2 - 2UC_t}{2c_p T_{t_{\text{in}}}}\right)^{\frac{\kappa}{\kappa-1}} = 0. \quad (159)$$

For an absolute-to-relative element the input is as follows (to be specified in that order on the line beneath the *FLUID SECTION, TYPE=ABSOLUTE TO RELATIVE card):

- U : circumferential velocity of the rotating device at the selected radius
- C_t : tangential gas velocity at the selected radius
- n : element immediately preceding the location of the transformation

C_t is taken if and only if $n = 0$. In all other cases the exit velocity of the element with label n is taken.

For an relative-to-absolute element the input is identical except that the type of the element is now RELATIVE TO ABSOLUTE.

Example files: moehring, vortex1, vortex2, vortex3.

6.4.23 In/Out

At locations where mass flow can enter or leave the network an element with node label 0 at the entry and exit, respectively, has to be specified.

Its fluid section type for gas networks can be any of the available types. The only effect the type has is whether the nonzero node is considered to be a chamber (zero velocity and hence the total temperature equals the static temperature) or a potential pipe connection (for a pipe connection node the total temperature does not equal the static temperature). The pipe connection types are GASPIPE, RESTRICTOR except for RESTRICTOR WALL ORIFICE and USER types starting with UP, all other types are chamber-like. A node is a pipe connection node if exactly two gas network elements are connected to this node and all of them are pipe connection types.

For chamber-like entries and exits it is strongly recommended to use the type INOUT, to be specified on the *FLUID SECTION card. For this type there are no extra parameters.

6.4.24 Mass Flow Percent

This is a loss-less element specifying that the mass flow through the element should be a certain percentage of the sum of the mass flow through up to 10 other elements. This element may be handy if measurement data are available which have to be matched.

The following constants must be entered (to be specified in that order on the line beneath the *FLUID SECTION, TYPE=MASSFLOW PERCENT card):

- value in per cent

- first element
- second element (if appropriate)
- third element (if appropriate)
- fourth element (if appropriate)
- fifth element (if appropriate)
- sixth element (if appropriate)
- seventh element (if appropriate)
- eighth element (if appropriate)
- ninth element (if appropriate)
- tenth element (if appropriate)

Example files: .

6.4.25 Network User Element

The user can define and code his/her own gas network element. The process of doing so requires the following steps:

- decide whether the element should be pipe-like (i.e. the total temperature and static temperature at the end nodes differ) or chamber-connecting-like (i.e. the element connects large chambers and the total and static temperatures at the end nodes are equal).
- choose a type name. For a pipe-like element the name has to start with “UP” followed by 5 characters to be chosen freely by the user (UPxxxxx). For a chamber-connecting-like element it has to start with “U”, followed by a character unequal to “P” and followed by 5 characters to be chosen freely by the user (Uyxxxxx, y unequal to “P”).
- decide on the number of constants to describe the element. This number has to be specified on the *FLUID SECTION card with the CONSTANTS parameter.
- add an entry in the if-construct in subroutine user_network_element.f. Notice that the type labels in the input deck (just as everything else, except file names) are converted into upper case when being read by CalculiX.
- write an appropriate user network element subroutine, e.g. user_network_element_pxxxxx.f or user_network_element_yxxxxx.f. Details can be found in Section 8.8. This routine describes how the total pressure at the end nodes, the total temperature at the end nodes and the mass flow through the element are linked.

- add an entry in the if-construct in subroutine calgeomelemnet.f (marked by START insert and END insert). This routine is used to determine the cross section area of the element (is used to calculate the static temperature from the total temperature).
- add an entry in the if-construct in subroutine calcheatnet.f (marked by START insert and END insert). This routine is used to calculate the heat generation e.g. due to centrifugal forces.

6.5 Fluid Section Types: Liquids

A network element is characterized by a type of fluid section. It has to be specified on the *FLUID SECTION card unless the analysis is a pure thermo-mechanical calculation.

Typical material properties needed for a liquid network are the density ρ (temperature dependent, cf. the *DENSITY card), the heat capacity $c = c_p = c_v$ and the dynamic viscosity μ (both temperature dependent and to be specified with the FLUID CONSTANTS card).

A special case is the purely thermal liquid network. This applies if:

- no TYPE is specified on any *FLUID SECTION card or
- the parameter THERMAL NETWORK is used on the *STEP card or
- all mass flow is given and either all pressures or given or none.

In that case only c_p is needed.

For liquids the orifice (only for $C_d = 1$), restrictor, branch, and vortex fluid section types of gases can be used by specifying the parameter LIQUID on the *FLUID SECTION card. In addition, the following types are available as well (the coefficients for the head losses are taken from [10], unless specified otherwise):

6.5.1 Pipe, Manning

This is a straight pipe with constant section and head losses $\Delta_1^2 F$ defined by the Manning formula:

$$\Delta_1^2 F = \frac{n^2 \dot{m}^2 L}{\rho^2 A^2 \mathcal{R}^{4/3}}, \quad (160)$$

where n is the Manning coefficient (unit: time/length^{1/3}), \dot{m} is the mass flux, L is the length of the pipe, ρ is the liquid density, A is the cross section of the pipe and \mathcal{R} is the hydraulic radius defined by the area of the cross section divided by its circumference (for a circle the hydraulic radius is one fourth of the diameter). The following constants have to be specified on the line beneath the *FLUID SECTION, TYPE=PIPE MANNING card (internal element label: DLIPIMA):

- area of the cross section (> 0)
- hydraulic radius of the cross section (area/perimeter, > 0)
- Manning coefficient $n \geq 0$

The length of the pipe is determined from the coordinates of its end nodes. Typical values for n are $n = 0.013\text{s/m}^{1/3}$ for steel pipes and $n = 0.015\text{s/m}^{1/3}$ for smooth concrete pipes (these values are for water. Notice that, since the dynamic viscosity does not show up explicitly in the Manning formula, n may be a function of the viscosity).

By specifying the addition FLEXIBLE in the type label the user can create a flexible pipe. In that case the user specifies two nodes, the distance between them being the radius of the pipe. These nodes have to be genuine structural nodes and should not belong to the fluid network. The distance is calculated from the location of the nodes at the start of the calculation modified by any displacements affecting the nodes. Consequently, the use of the *COUPLED TEMPERATURE-DISPLACEMENT keyword allows for a coupling of the deformation of the pipe wall with the flow in the pipe. The following constants have to be specified on the line beneath the *FLUID SECTION, TYPE=PIPE MANNING FLEXIBLE card (internal element label: DLIPI-MAF):

- node number 1 (> 0)
- node number 2 (> 0)
- Manning coefficient $n \geq 0$

Example files: artery1, artery2, centheat1, centheat2, pipe, piperestrictor.

6.5.2 Pipe, White-Colebrook

This is a straight pipe with constant section and head losses $\Delta_1^2 F$ defined by the formula:

$$\Delta_1^2 F = \frac{f \dot{m}^2 L}{2g\rho^2 A^2 D}, \quad (161)$$

where f is the White-Colebrook coefficient (dimensionless), \dot{m} is the mass flux, L is the length of the pipe, g is the gravity acceleration (9.81m/s^2), A is the cross section of the pipe and D is the diameter. The White-Colebrook coefficient satisfies the following implicit equation:

$$\frac{1}{\sqrt{f}} = -2.03 \log \left(\frac{2.51}{\text{Re}\sqrt{f}} + \frac{k_s}{3.7D} \right). \quad (162)$$

Here, k_s is the diameter of the material grains at the surface of the pipe and Re is the Reynolds number defined by

$$\text{Re} = \frac{UD}{\nu}, \quad (163)$$

where U is the liquid velocity and ν is the kinematic viscosity. It satisfies $\nu = \mu/\rho$ where μ is the dynamic viscosity.

The following constants have to be specified on the line beneath the *FLUID SECTION, TYPE=PIPE WHITE-COLEBROOK card (internal element label: DLIPIWC):

- area of the cross section (> 0)
- hydraulic diameter of the cross section (4 times the area divided by the perimeter, > 0)
- length of the pipe element; if this number is nonpositive the length is calculated from the coordinates of the pipe's end nodes.
- the grain diameter $k_s > 0$
- form factor $\varphi > 0$ of the cross section

The gravity acceleration must be specified by a gravity type *DLOAD card defined for the elements at stake. The material characteristics ρ and μ can be defined by a *DENSITY and *FLUID CONSTANTS card. Typical values for k_s are 0.25 mm for cast iron, 0.1 mm for welded steel, 1.2 mm for concrete, 0.006 mm for copper and 0.003 mm for glass.

The form factor φ is only used to modify the friction expression for non-circular cross sections in the laminar regime as follows ($\varphi = 1$ for a circular cross section):

$$f = \varphi \frac{64}{\text{Re}}. \quad (164)$$

Values for φ for several cross sections can be found in [13]. For a square cross section its value is 0.88, for a rectangle with a height to width ratio of 2 its value is 0.97.

By specifying the addition FLEXIBLE in the type label the user can create a flexible pipe. In that case the user specifies two nodes, the distance between them being the radius of the pipe. These nodes have to be genuine structural nodes and should not belong to the fluid network. The distance is calculated from the location of the nodes at the start of the calculation modified by any displacements affecting the nodes. Consequently, the use of the *COUPLED TEMPERATURE-DISPLACEMENT keyword allows for a coupling of the deformation of the pipe wall with the flow in the pipe. The following constants have to be specified on the line beneath the *FLUID SECTION, TYPE=PIPE WHITE-COLEBROOK FLEXIBLE card (internal element label: DLIPIWCF):

- node number 1 (> 0)

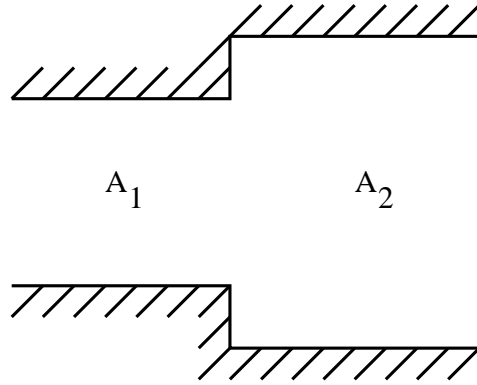

Figure 112: Sudden Enlargement

- node number 2 (> 0)
- length of the pipe element; if this number is nonpositive the length is calculated from the coordinates of the pipe's end nodes.
- the grain diameter $k_s > 0$
- form factor $\varphi > 0$ of the cross section

Example files: pipe2.

6.5.3 Pipe, Sudden Enlargement

A sudden enlargement (Figure 112) is characterized by head losses $\Delta_1^2 F$ of the form:

$$\Delta_1^2 F = \zeta \frac{\dot{m}^2}{2g\rho^2 A_1^2}, \quad (165)$$

where ζ is a head loss coefficient depending on the ratio A_1/A_2 , \dot{m} is the mass flow, g is the gravity acceleration and ρ is the liquid density. A_1 and A_2 are the smaller and larger cross section, respectively. Notice that this formula is only valid for $\dot{m} \geq 0$. For a reverse mass flow, the formulas for a pipe contraction have to be taken. Values for ζ can be found in file "liquidpipe.f".

The following constants have to be specified on the line beneath the *FLUID SECTION, TYPE=PIPE ENLARGEMENT card (internal element label: DLIPIEL):

- $A_1 > 0$

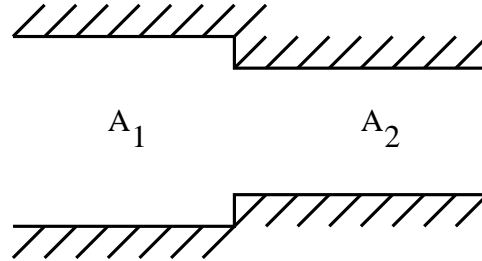

Figure 113: Sudden Contraction

- $A_2 (\geq A_1)$

The gravity acceleration must be specified by a gravity type *DLOAD card defined for the elements at stake. The material characteristic ρ can be defined by a *DENSITY card.

Example files: centheat1, pipe.

6.5.4 Pipe, Sudden Contraction

A sudden contraction (Figure 113) is characterized by head losses $\Delta_1^2 F$ of the form:

$$\Delta_1^2 F = \zeta \frac{\dot{m}^2}{2g\rho^2 A_2^2}, \quad (166)$$

where ζ is a head loss coefficient depending on the ratio A_2/A_1 , \dot{m} is the mass flow, g is the gravity acceleration and ρ is the liquid density. A_1 and A_2 are the larger and smaller cross section, respectively. Notice that this formula is only valid for $\dot{m} \geq 0$. For a reverse mass flow, the formulas for a pipe enlargement have to be taken. Values for ζ can be found in file “liquidpipe.f”.

The following constants have to be specified on the line beneath the *FLUID SECTION, TYPE=PIPE CONTRACTION card (internal element label: DLIPICO):

- $A_1 > 0$
- $A_2 (\leq A_1, > 0)$

The gravity acceleration must be specified by a gravity type *DLOAD card defined for the elements at stake. The material characteristic ρ can be defined by a *DENSITY card.

Example files: centheat1, pipe.

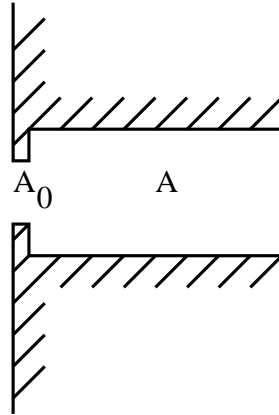

Figure 114: Entrance

6.5.5 Pipe, Entrance

A entrance (Figure 114) is characterized by head losses $\Delta_1^2 F$ of the form:

$$\Delta_1^2 F = \zeta \frac{\dot{m}^2}{2g\rho^2 A^2}, \quad (167)$$

where ζ is a head loss coefficient depending on the ratio A_0/A , \dot{m} is the mass flow, g is the gravity acceleration and ρ is the liquid density. A_0 and A are the cross section of the entrance and of the pipe, respectively. Values for ζ can be found in file “liquidpipe.f”.

The following constants have to be specified on the line beneath the *FLUID SECTION, TYPE=PIPE ENTRANCE card (internal element label: DLIPIEN):

- $A > 0$
- A_0 ($\leq A, > 0$)

The gravity acceleration must be specified by a gravity type *DLOAD card defined for the elements at stake. The material characteristic ρ can be defined by a *DENSITY card.

Example files: pipe, piperestrictor.

6.5.6 Pipe, Diaphragm

A diaphragm (Figure 115) is characterized by head losses $\Delta_1^2 F$ of the form:

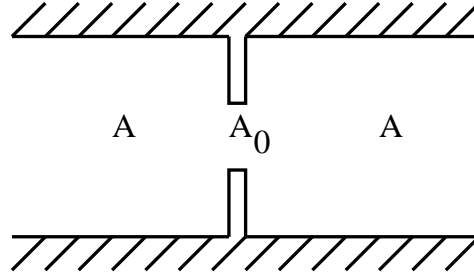

Figure 115: Diaphragm

$$\Delta_1^2 F = \zeta \frac{\dot{m}^2}{2g\rho^2 A^2}, \quad (168)$$

where ζ is a head loss coefficient depending on the ratio A_0/A , \dot{m} is the mass flow, g is the gravity acceleration and ρ is the liquid density. A_0 and A are the cross section of the diaphragm and of the pipe, respectively. Values for ζ can be found in file “liquidpipe.f”.

The following constants have to be specified on the line beneath the *FLUID SECTION, TYPE=PIPE DIAPHRAGM card (internal element label: DLIPIDI):

- $A > 0$
- A_0 ($\leq A, > 0$)

The gravity acceleration must be specified by a gravity type *DLOAD card defined for the elements at stake. The material characteristic ρ can be defined by a *DENSITY card.

6.5.7 Pipe, Bend

A bend (Figure 116) is characterized by head losses $\Delta_1^2 F$ of the form:

$$\Delta_1^2 F = \zeta \frac{\dot{m}^2}{2g\rho^2 A^2}, \quad (169)$$

where ζ is a head loss coefficient depending on the bend angle α and the ratio of the bend radius to the pipe diameter R/D , \dot{m} is the mass flow, g is the gravity acceleration and ρ is the liquid density. A is the cross section of the pipe. Values for ζ can be found in file “liquidpipe.f”.

The following constants have to be specified on the line beneath the *FLUID SECTION, TYPE=PIPE BEND card (internal element label: DLIPIBE):

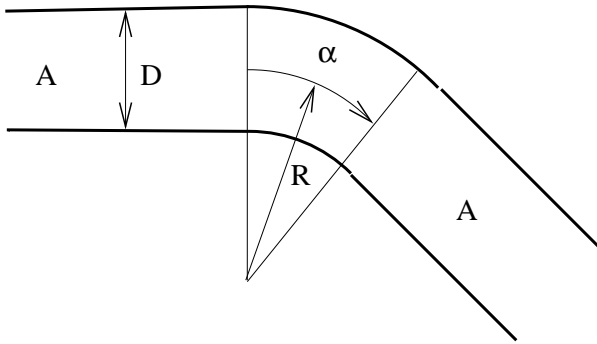

Figure 116: Bend

- $A > 0$
- $R/D \ (\geq 1)$
- α (in $^\circ$), > 0
- ξ ($0 \leq \xi \leq 1$)

ξ denotes the roughness of the pipe: $\xi = 0$ applies to an extremely smooth pipe surface, $\xi = 1$ to a very rough surface. The gravity acceleration must be specified by a gravity type *DLOAD card defined for the elements at stake. The material characteristic ρ can be defined by a *DENSITY card.

Example files: centheat1, pipe.

6.5.8 Pipe, Gate Valve

A gate valve (Figure 117) is characterized by head losses $\Delta_1^2 F$ of the form:

$$\Delta_1^2 F = \zeta \frac{\dot{m}^2}{2g\rho^2 A^2}, \quad (170)$$

where ζ is a head loss coefficient depending on the ratio $\alpha = x/D$, \dot{m} is the mass flow, g is the gravity acceleration and ρ is the liquid density. A is the cross section of the pipe, x is a size for the remaining opening (Figure 117) and D is the diameter of the pipe. Values for ζ can be found in file "liquidpipe.f".

The following constants have to be specified on the line beneath the *FLUID SECTION, TYPE=PIPE GATE VALVE card (internal element label: DLIPIGV):

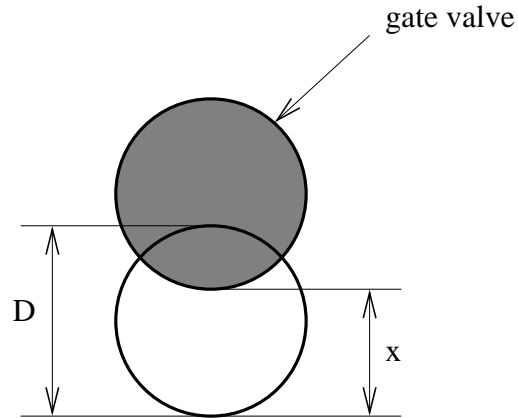

Figure 117: Gatevalve

- $A > 0$
- α ($0.125 \leq \alpha \leq 1$)

The gravity acceleration must be specified by a gravity type *DLOAD card defined for the elements at stake. The material characteristic ρ can be defined by a *DENSITY card.

For the gate valve the inverse problem can be solved too. If the user defines a value for $\alpha \leq 0$, α is being solved for. In that case the mass flow must be defined as boundary condition. Thus, the user can calculate the extent to which the valve must be closed to obtain a predefined mass flow. Test example pipe2.inp illustrates this feature.

Example files: pipe2, pipe, piperestrictor.

6.5.9 Pump

A pump is characterized by a total head increase versus total flow curve (Figure 118). The total head h is defined by:

$$h = z + \frac{p}{\rho g}, \quad (171)$$

where z is the vertical elevation, p is the pressure, ρ is the liquid density and g is the value of the earth acceleration. The total flow Q satisfies:

$$Q = \dot{m}/\rho, \quad (172)$$

where \dot{m} is the mass flow. The pump characteristic can be defined underneath a *FLUID SECTION,TYPE=LIQUID PUMP by discrete data points on

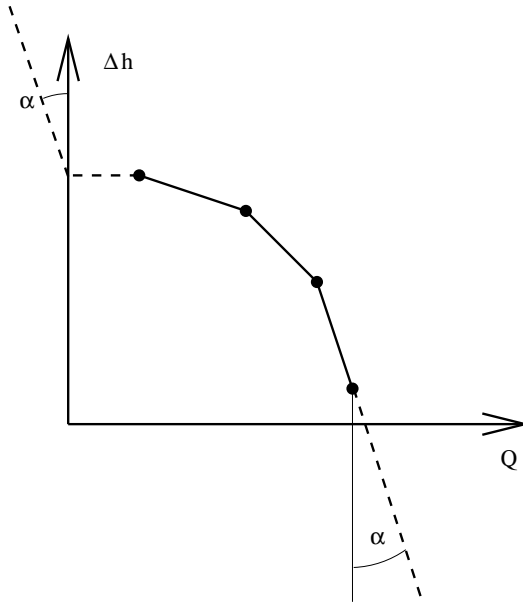

Figure 118: Pump Characteristic

the curve (internal element label: DLIPU). The data points should be given in increasing total flow order and the corresponding total head values must be decreasing. No more than 10 pairs are allowed. In between the data points CalculiX performs an interpolation (solid line in Figure 118). For flow values outside the defined range an extrapolation is performed, the form of which depends on the precise location of the flow (dashed lines in Figure 118). For positive flow values inferior to the lowest flow data point, the total head corresponding to this lowest flow data point is taken (horizontal dashed line). For negative flow values the total head sharply increases ($\alpha = 0.0001$) to simulate the zero-flow conditions of the pump in that region. For flow values exceeding the largest flow data point the total head decreases sharply with the same tangent α .

The gravity acceleration must be specified by a gravity type *DLOAD card defined for the elements at stake. The material characteristic ρ can be defined by a *DENSITY card.

The liquid is defined by the following parameters (to be specified in that order on the line beneath the *FLUID SECTION, TYPE=LIQUID PUMP card):

- not used
- X_1
- Y_1
- X_2

- Y_2
- ... (maximum 16 entries per line, use more lines if you want to define more than 7 pairs, maximum 9 pairs in total)

Example files: centheat1.

6.5.10 In/Out

At locations where mass flow can enter or leave the network an element with node label 0 at the entry and exit, respectively, has to be specified. Its fluid section type for liquid pipe networks must be PIPE INOUT, to be specified on the *FLUID SECTION card. For this type there are no extra parameters.

6.6 Fluid Section Types: Open Channels

A network element is characterized by a type of fluid section. It has to be specified on the *FLUID SECTION card unless the analysis is a pure thermo-mechanical calculation (no calculation of pressure, mass flow or fluid depth). For an open channel network the boundary conditions for each branch are located upstream (frontwater flow) or downstream (backwater flow). These boundary conditions are made up of special elements, such as a sluice gate or a weir. Nearly all of these elements actually consist of pairs of elements, which reference each other. For instance, adjacent and downstream of the sluice gate element a sluice opening element has to be defined. The upstream element of such a pair has an additional degree of freedom attached to its middle node to accommodate the location of any hydraulic jump which might occur in the downstream channel branch. Therefore, all elements downstream of a pair of such boundary elements have to reference the upstream element of the pair. In our example, this is the sluice gate element. The friction in all elements is modeled by the White-Colebrook law, unless the parameter MANNING is specified on the *FLUID SECTION card. For details on these laws the reader is referred to Section 6.9.18.

6.6.1 Straight Channel

The straight channel is characterized by a trapezoidal cross section with constant width b and trapezoidal angle θ . This is illustrated in Figure 119. The following constants have to be specified on the line beneath the *FLUID SECTION,TYPE=CHANNEL STRAIGHT card:

- the width b
- the trapezoid angle θ
- the length L (if $L \leq 0$ the length is calculated from the coordinates of the end nodes belonging to the element)

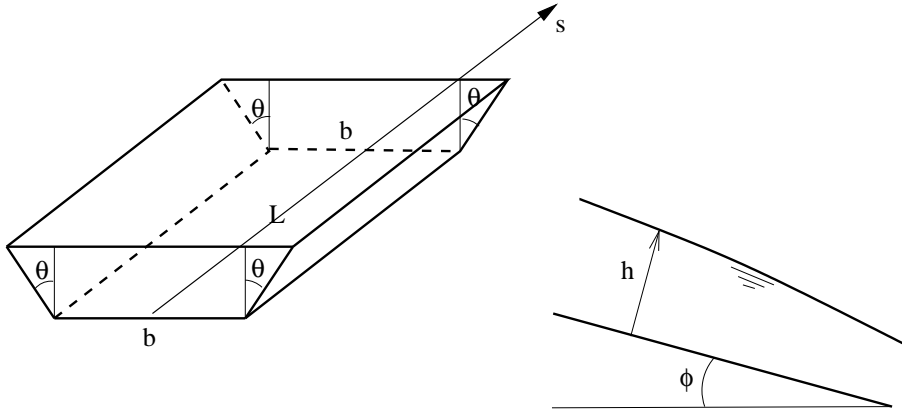

Figure 119: Channel geometry

- the slope $S_0 = \sin \phi$ (if $S_0 < -1$ the slope is calculated from the coordinates of the end nodes belonging to the element)
- the grain diameter k_s for the White-Colebrook law or the Manning constant n for the Manning law (in the latter case the user has to specify the parameter MANNING on the *FLUID SECTION card)

Example files: channel1, chanson1.

6.6.2 Sluice Gate

The sluice gate is the upstream element of a channel and is illustrated in Figure 120. The element downstream of a sluice gate should be a straight channel element. The interesting point is that the gate height h_g may be part of the backwater curve, but it does not have to. If the lower point of the gate is higher than the fluid surface, it will not be part of the backwater curve.

If the gate door touches the water and the water curve is a frontwater curve (curve A in Figure 120) the volumetric flow Q is given by (assuming $\theta = 0$)

$$Q = bh_g \sqrt{2g(h - h_g \sqrt{1 - S_0^2})}, \quad (173)$$

if the gate door does not touch the water and the water curve is a frontwater curve the volumetric flow Q is given by

$$Q = bh_c \sqrt{2g(h - h_c \sqrt{1 - S_0^2})}, \quad (174)$$

where h_c is the critical depth. The critical depth is the value of h_c in the above equation for which Q is maximal. For a rectangular cross section $h_c = 2h/3$. If the gate door touches the water and the water curve is a backwater

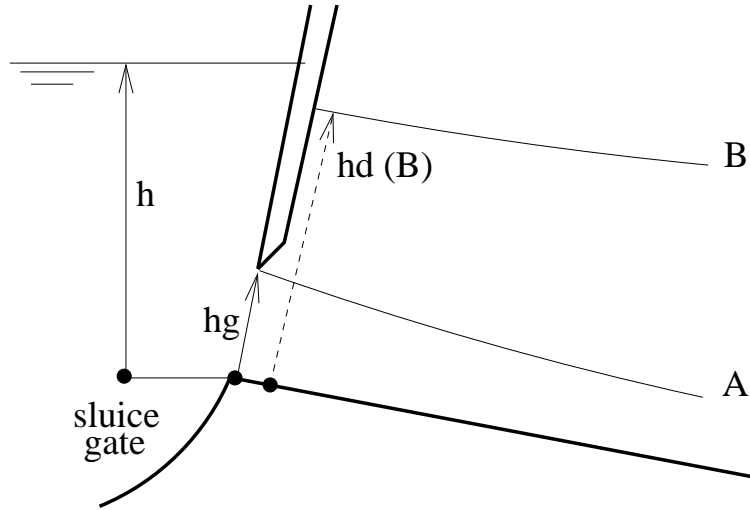

Figure 120: Sluice gate geometry

curve (governed by downstream boundary conditions, curve B in Figure 120)) the volumetric flow is given by

$$Q = bh_g \sqrt{2g(h - h_d \sqrt{1 - S_0^2})}. \quad (175)$$

Finally, if the gate door does not touch the water and the water curve is a backwater curve the volumetric flow is given by

$$Q = bh_d \sqrt{2g(h - h_d \sqrt{1 - S_0^2})}. \quad (176)$$

The following constants have to be specified on the line beneath the *FLUID SECTION,TYPE=CHANNEL SLUICE GATE card (the width, the trapezoid angle, the slope and the grain diameter should be the same as for the downstream element immediately next to the sluice gate; they are needed for the calculation of the critical height and normal height):

- the width b
- the trapezoid angle θ
- not used
- the slope $S_0 = \sin \phi$, $-1 < S_0 < 1$ (for this element the slope must be given explicitly and is not calculated from the coordinates of the end nodes belonging to the element)

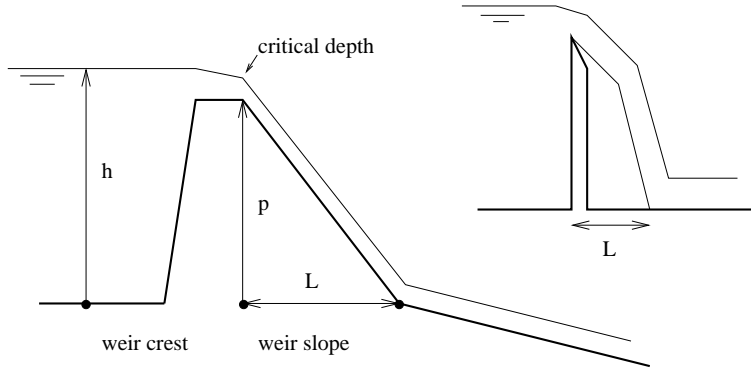

Figure 121: Weir geometry

- the grain diameter k_s for the White-Colebrook law or the Manning constant n for the Manning law (in the latter case the user has to specify the parameter MANNING on the *FLUID SECTION card)
- the height of the gate door h_g

Example files: channel1, chanson1.

6.6.3 Weir

A wear is a structure as in Figure 121 at the upstream end of a channel. The weir can occur in different forms such as broad-crested weirs (left picture in the Figure) and sharp-crested weirs (right picture in the Figure). The wear element in CalculiX can be used to simulate the part of the wear to the left of the highest point, which is the point at which critical flow is observed. The part to the right of this point (denoted by “L” in the figure) has to be modeled by a straight channel element with high slope or by a step element with negative step size (i.e. drop).

The volumetric flow Q can be characterized by a law of the form

$$Q = Cb(h - p)^{3/2}, \quad (177)$$

where C is a constant. For instance, in the formula by Poleni $C = 2C_d\sqrt{2g}/3$, where C_d is coefficient smaller than 1 to be measured experimentally [11]. The flow across a wear corresponds to the flow underneath a sluice gate with infinite depth underneath the gate and critical conditions, therefore (Equation (174), for $\theta = 0$ and $S_0 = 0$):

$$Q = C^*bh_c\sqrt{2g(h - h_c)}, \quad (178)$$

where C^* now satisfies (by equating to the above equations and taking $h_c = 2h/3$ and $p = 0$):

$$C^* = \frac{C}{\sqrt{g}} (3/2)^{3/2}. \quad (179)$$

The following constants have to be specified on the line beneath the *FLUID SECTION,TYPE=CHANNEL WEIR card:

- the width b
- not used
- not used
- not used
- the grain diameter k_s for the White-Colebrook law or the Manning constant n for the Manning law (in the latter case the user has to specify the parameter MANNING on the *FLUID SECTION card)
- the height of the weir p
- the weir constant C

A wear can only be used at the upstream end of a channel. A wear in the middle of a channel has to be modeled by a step followed by a drop.

Example files: channel7.

6.6.4 Reservoir

A reservoir is a downstream boundary condition. The element immediately upstream should be a straight channel element. The following constants have to be specified on the line beneath the *FLUID SECTION,TYPE=CHANNEL RESERVOIR card:

- the width b
- the trapezoid angle θ
- not used
- the slope $S_0 = \sin \phi$, $-1 < S_0 < 1$ (for this element the slope must be given explicitly and is not calculated from the coordinates of the end nodes belonging to the element)
- the grain diameter k_s for the White-Colebrook law or the Manning constant n for the Manning law (in the latter case the user has to specify the parameter MANNING on the *FLUID SECTION card)

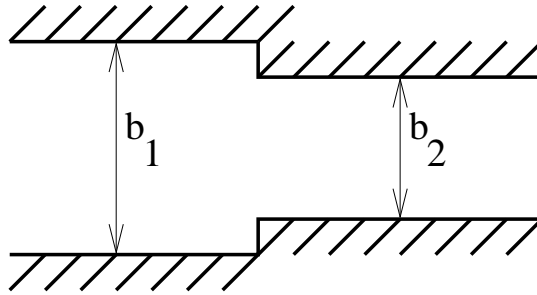

Figure 122: Geometry of a contraction

The width, the trapezoid angle, the slope and the grain diameter are needed to calculate the critical and normal depth. They should be the same as the straight channel element immediately upstream of the reservoir.

The water depth in the downstream node of a reservoir element must be defined by the user by means of a *BOUNDARY card (degree of freedom 2).

Example files: channel1, chanson1.

6.6.5 Contraction

The geometry of a contraction is shown in Figure 122 (view from above). The flow is assumed to take place from left to right. To calculate the fluid depth following a contraction based on the fluid depth before the contraction (or vice versa) the specific energy is used (cf. Section 6.9.18). At a contraction the channel floor elevation does not change, so the specific energy after the contraction minus the specific energy before the contraction amounts to the head loss. Assuming at first no head loss, the specific energies are the same.

Figure 123 shows $Q(h)$ for a fixed specific energy before and after a contraction and assuming a rectangular cross section. Since for a rectangular section

$$Q = bh\sqrt{2g(E - h \cos \varphi)}, \quad (180)$$

the curve after the contraction is just scaled in Q-direction. From the figure we notice that due to the contraction the fluid depth increases if the flow is supercritical and decreases if it is subcritical. The inverse is true for an enlargement. Writing the above expression before and after the contraction for the more general case of a trapezoidal section:

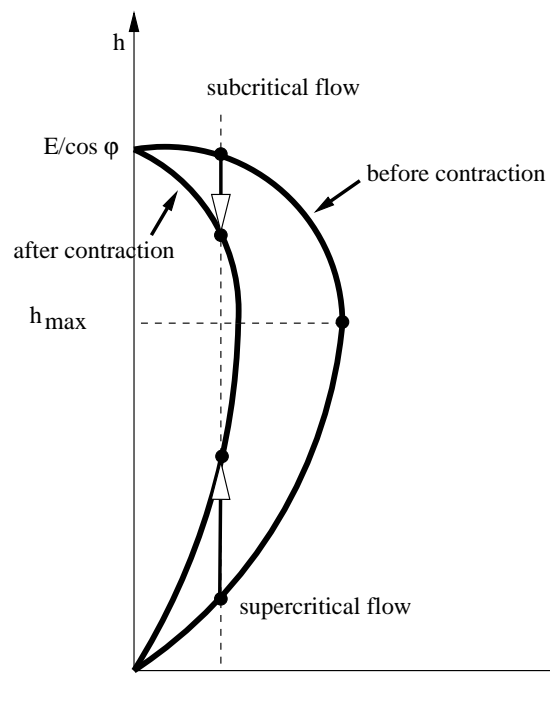

Figure 123: Specific energy at a contraction

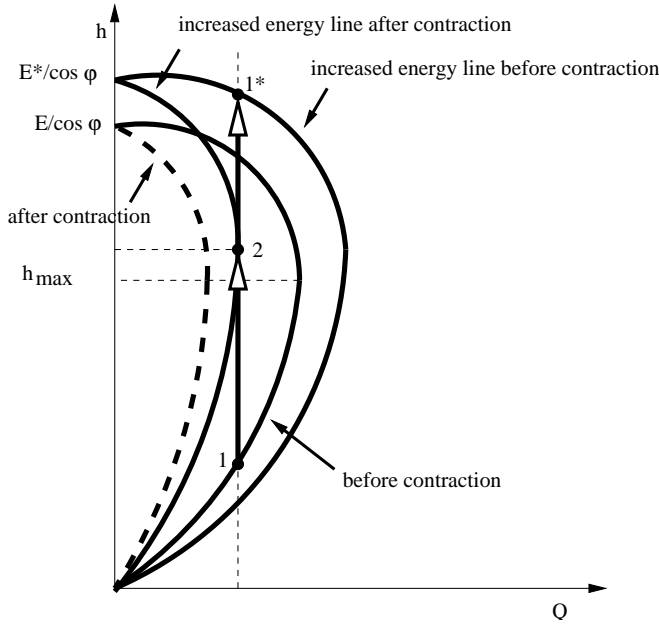

Figure 124: Specific energy increase to cope with the upstream volumetric flow

$$A_1 \sqrt{2g(E - h_1 \cos \varphi)} = A_2 \sqrt{2g(E - h_2 \cos \varphi)}, \quad (181)$$

one arrives at:

$$\frac{A_2}{A_1} = \frac{\sqrt{(E - h_1 \cos \varphi)}}{\sqrt{(E - h_2 \cos \varphi)}}. \quad (182)$$

This means that if $h_2 > h_1$ then $A_2 > A_1$ and vice versa. Due to the conservation of mass we then find that if $h_2 > h_1$ then $U_2 < U_1$ and vice versa. So the fluid velocity decreases for supercritical flow and increases for subcritical flow at a contraction.

Now, if the contraction is strong it can happen that the new specific energy line does not have an intersection with the volumetric flow at stake (dashed line in Figure 124). Assume the flow before the contraction is supercritical (point 1 in the figure). Then, to solve the problem of a lacking intersection the specific energy after the contraction is increased so that the energy line barely touches the volumetric flow. This takes place for the critical depth of this energy line, since it is at this height that the flow is maximal and the flow only increases its energy as much as barely needed. So after the contraction the flow is characterized by point 2. In downstream direction it is the start of a supercritical frontwater curve within the contraction. In upstream direction it is the first point of a subcritical backwater curve, for which looking in upstream direction the contraction looks like an enlargement. Therefore, the upstream

condition of the contraction is now represented by point 1* (the width has increased and the energy line is scaled by a factor exceeding one). This point will be connected to the original frontwater curve ahead of the contraction by a hydraulic jump.

Another way of looking at this is by realizing that the increased specific energy needed to accommodate the given flow within the contraction can only be obtained by decreasing the energy loss upstream of the contraction. This is done by a decrease of the friction, obtained by lifting the supercritical flow to a subcritical level. Indeed, a larger fluid depth corresponds to less friction.

The previous considerations did not take head losses into account. The head loss at the contraction can be approximated by (obtained by experimental evidence):

$$\Delta F = \left| \frac{\alpha}{\pi} \left(\frac{U_2^2 - U_1^2}{2} \right) \right|, \quad (183)$$

where $-\pi/2 \leq \alpha \leq 0$ is the contraction angle in radians ($\tan \alpha = (b_2 - b_1)/L$, where L is the length of the contraction). For supercritical flow $U_2 < U_1$ and consequently:

$$\Delta F = -\frac{\alpha}{\pi} \left(\frac{U_1^2 - U_2^2}{2g} \right), \quad (184)$$

leading to the following relation between the upstream and downstream specific energy:

$$h_1 \cos \varphi + \frac{U_1^2}{2g} + \frac{\alpha}{\pi} \frac{U_1^2}{2g} = h_2 \cos \varphi + \frac{U_2^2}{2g} + \frac{\alpha}{\pi} \frac{U_2^2}{2g}, \quad (185)$$

or

$$h_1 \cos \varphi + \left(1 + \frac{\alpha}{\pi}\right) \frac{U_1^2}{2g} = h_2 \cos \varphi + \left(1 + \frac{\alpha}{\pi}\right) \frac{U_2^2}{2g}. \quad (186)$$

This means that the head loss can be taken into account by replacing g in the specific energy by $\pi g/(\pi + \alpha)$.

For subcritical flow $U_1 < U_2$ and g has to be replaced by $\pi g/(\pi - \alpha)$.

The following constants have to be specified on the line beneath the *FLUID SECTION,TYPE=CHANNEL CONTRACTION card:

- width of the channel at node 1 (first node in the topology of the element)
- trapezoidal angle of the channel at node 1
- width of the channel at node 3 (third node in the topology of the element)
- trapezoidal angle of the channel at node 3
- not used

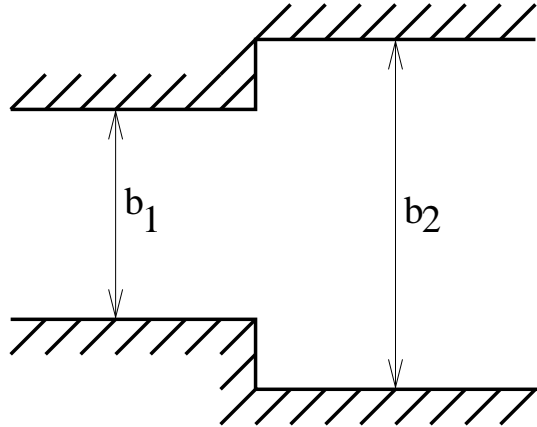

Figure 125: Geometry of an enlargement

- the length of the contraction. This is used to calculate the contraction angle from $\tan \alpha = (b_2 - b_1)/L$ (if $L \leq 0$ the length is calculated from the coordinates of the end nodes belonging to the element).
- the slope $S_0 = \sin \phi$, $-1 < S_0 < 1$ (for this element the slope must be given explicitly and is not calculated from the coordinates of the end nodes belonging to the element)

Example files: channel9, channel11.

6.6.6 Enlargement

The geometry of an enlargement is shown in Figure 125 (view from above). Similar to the case of a contraction, the fluid depth following an enlargement (for supercritical flow) or vice versa (for subcritical flow) using the specific energy and Figure 123 can be reused by replacing “after contraction” by “before enlargement” and “before contraction” by “after enlargement”. For supercritical flow the fluid depth decreases and the velocity increases at an enlargement, for subcritical flow the fluid depth increases and the velocity decreases. For subcritical flow, for which the depth downstream of the enlargement is known, the enlargement (which is a contraction when looking upstream) may be so large that there is no intersection with the specific energy curve upstream (cf. Figure 124 in which “after contraction” is replaced by “before enlargement” etcetera). In that case the specific energy upstream of the enlargement is increased up to the point

that the curve barely touches the given volumetric flow (for the critical depth). This will lead to supercritical flow within the enlargement and a subsequent jump downstream. Another way of looking at that is that the friction in the enlargement has to increase (by a smaller depth) in order to compensate the higher specific energy upstream of the enlargement.

The head loss at an enlargement can be approximated by:

$$\Delta F = \left| k \left(\frac{U_2^2 - U_1^2}{2} \right) \right|. \quad (187)$$

For supercritical flow this amounts to replacing g by $g/(1+k)$ in the definition of the specific energy and for subcritical flow by replacing g by $g/(1-k)$. Values of k are 0, 0.27, 0.41, 0.68, 0.87 and 0.87 for $\alpha = 0., 0.25, 0.32, 0.46, 0.79$ and $\pi/2$, respectively [11]. In between, linear interpolation is applied. α is defined by $\tan \alpha = (b_2 - b_1)/L$.

The following constants have to be specified on the line beneath the *FLUID SECTION,TYPE=CHANNEL ENLARGEMENT card:

- width of the channel at node 1 (first node in the topology of the element)
- trapezoidal angle of the channel at node 1
- width of the channel at node 3 (third node in the topology of the element)
- trapezoidal angle of the channel at node 3
- not used
- the length of the contraction. This is used to calculate the contraction angle from $\tan \alpha = (b_2 - b_1)/L$ (if $L \leq 0$ the length is calculated from the coordinates of the end nodes belonging to the element).
- the slope $S_0 = \sin \phi$, $-1 < S_0 < 1$ (for this element the slope must be given explicitly and is not calculated from the coordinates of the end nodes belonging to the element)

Example files: channel9, channel11.

6.6.7 Step

The geometry of a step is the inverse of the drop geometry. Although a step is really a discontinuity, a small fictitious length and a slope have to be assigned. For the slope one can take the mean values of the slopes of the adjacent channels. The following constants have to be specified on the line beneath the *FLUID SECTION,TYPE=CHANNEL STEP card:

- width of the channel
- trapezoidal angle of the channel section

- not used
- not used
- height of the step (i.e. change in the bottom when going from node 1 to node 3 in the element topology; if negative it is a drop)
- not used
- the slope $S_0 = \sin \phi$, $-1 < S_0 < 1$ (for this element the slope must be given explicitly and is not calculated from the coordinates of the end nodes belonging to the element)

Example files: channel10, channel12.

6.6.8 Channel joint

This is not a channel element. Rather, the channel joint is modeled by using three standard straight channel elements, in two of which the mass flow is entering the joint (the “joining” elements) and in the remaining it is leaving the joint. Within each of the joining elements the fluid depth is not assumed to change. Therefore it is important that the length of all three elements is chosen sufficiently small. No other elements are allowed in a joint (so also no In/Out elements).

If a frontwater curve prevails in both the joining elements the frontwater curve with the highest depth is pursued downstream (also a frontwater curve) and the other curve either simply connected or connected through a jump. No energy loss is taken into account.

If a frontwater curve prevails in only one of the joining elements this curve is continued downstream (also a frontwater curve) and a backwater curve is calculated for the other joining element. No energy loss is taken into account.

If a backwater curve prevails in both the joining elements also the downstream element is characterized by a backwater curve. Here, the Bernoulli equation is assumed to contain a head loss in the following form [11]:

$$h_i + \frac{U_i^2}{2g} = h_0 + \frac{U_0^2}{2g} + \alpha_i \left| \frac{U_i^2}{2g} - \frac{U_0^2}{2g} \right|, \quad (188)$$

where $i = 1, 2$ denotes one of the joining channels, and α_i is the angle between channel i and the downstream channel, normalized by π . Consequently, it takes the value 0 for $\alpha_i = 0$ and 1 for $\alpha_i = \pi$. It is assumed that the mass flow in the upstream channels is known. In the downstream channel also the velocity is known (the depth is known since it is a backwater curve). The velocities and depths in the upstream channels, however, are unknown. Starting with a split up of the downstream velocity proportional to the mass flow, the depth h_i can be calculated in each of the upstream channels. This allows for an update of U_i . This procedure is continued until convergence is reached.

6.6.9 In/Out

At locations where mass flow can enter or leave the network an element with node label 0 at the entry and exit, respectively, has to be specified. Its fluid section type for liquid channel networks must be CHANNEL INOUT, to be specified on the *FLUID SECTION card. For this type there are no extra parameters.

If this type of element is connected to exactly one other element type, the entering mass flow has to be specified in the middle node using a *BOUNDARY card and, if the calculation is thermal, the temperature at the downstream node. If the mass flow is exiting the network nothing should be prescribed. If a In/Out element is connected two elements not of the In/Out type the mass flow always has to be specified, irrespective whether it is entering or leaving the network. Furthermore, for a thermal calculation also the temperature has to be specified as degree of freedom 0 or 11 at the middle node. This is an exception to the rule that temperatures can only be defined in end nodes due to the fact that the external end node of a In/Out element has node number zero. A channel calculation is considered to be thermal if the above temperature rules are satisfied. Furthermore, for thermal channel calculations the definition of absolute zero using a *PHYSICAL CONSTANTS card is mandatory.

Example files: channel14, channeljoint1.

6.7 Boundary conditions

6.7.1 Single point constraints (SPC)

In a single point constraint one or more degrees of freedom are fixed for a given node. The prescribed value can be zero or nonzero. Nonzero SPC's cannot be defined outside a step. Zero SPC's can be defined inside or outside a step. SPC's are defined with the keyword *BOUNDARY. The mechanical degrees of freedom are labeled 1 through 6 (1 = translation in x, 2 = translation in y, 3 = translation in z, 4 = rotation about x, 5 = rotation about y, 6 = rotation about z), the thermal degree of freedom is labeled 11. Rotational degrees of freedom can be applied to beam and shell elements only.

6.7.2 Multiple point constraints (MPC)

Multiple point constraints establish a relationship between degrees of freedom in one or more nodes. In this section, only linear relationships are considered (for nonlinear relations look at the keyword *MPC and section 8.7). They must be defined with the keyword *EQUATION before the first step. An inhomogeneous linear relationship can be defined by assigning the inhomogeneous term to one of the degrees of freedom (DOF) of a dummy node (using a SPC) and including this DOF in the MPC, thus homogenizing it. The numbering of the DOF's is the same as for SPC's (cf previous section). It is not allowed to mix thermal and mechanical degrees of freedom within one and the same MPC.

6.7.3 Kinematic and Distributing Coupling

In this section the theoretical background of the keyword *COUPLING followed by *KINEMATIC or *DISTRIBUTING is covered, and not the keyword DISTRIBUTING COUPLING.

Coupling constraints generally lead to nonlinear equations. In linear calculations (without the parameter NLGEOM on the *STEP card) these equations are linearized once and solved. In nonlinear calculations, iterations are performed in each of which the equations are linearized at the momentary solution point until convergence.

Coupling constraints apply to all nodes of a surface given by the user. In a kinematic coupling constraint by the user specified degrees of freedom in these nodes follow the rigid body motion about a reference point (also given by the user). In CalculiX the rigid body equations elaborated in section 3.5 of [23] are implemented. Since CalculiX does not have internal rotational degrees of freedom, the translational degrees of freedom of an extra node (rotational node) are used for that purpose, cf. *RIGID BODY. Therefore, in the case of kinematic coupling the following equations are set up:

- 3 equations connecting the rotational degrees of freedom of the reference node to the translational degrees of freedom of an extra rotational node.
- per node belonging to the surface at stake, for each degree of freedom specified by the user (maximum 3) a rigid body equation.

This applies if no ORIENTATION was used on the *COUPLING card, i.e. the specified degrees of freedom apply to the global coordinate system. If an ORIENTATION parameter is used, the degrees of freedom apply in a local system. Then, the nodes belonging to the surface at stake (let us give them the numbers 1,2,3...) are duplicated (let us call these d1,d2,d3.....) and the following equations are set up:

- 3 equations connecting the rotational degrees of freedom of the reference node to the translational degrees of freedom of an extra rotational node.
- per duplicated node belonging to the surface at stake, a rigid body equation for each translational degree of freedom (i.e. 3 per duplicated node).
- per node an equation equating the by the user specified degrees of freedom in the local system (maximum 3) to the same ones in the duplicated nodes.

The approach for distributing coupling is completely different. Here, the purpose is to redistribute forces and moments defined in a reference node across all nodes belonging to a facial surface define on a *COUPLING card. No kinematic equations coupling the degrees of freedom of the reference node to the ones in the coupling surface are generated. Rather, a system of point loads equivalent to the forces and moments in the reference node is applied in the nodes of the coupling surface.

To this end the center of gravity \mathbf{x}_{cg} of the coupling surface is determined by:

$$\mathbf{x}_{cg} = \sum_i \mathbf{x}_i w_i, \quad (189)$$

where \mathbf{x}_i are the locations of the nodes belonging to the coupling surface and w_i are weights taking the area into account for which each of the nodes is “responsible”. We have:

$$\sum_i w_i = 1. \quad (190)$$

The relative position \mathbf{r}_i of the nodes is expressed by:

$$\mathbf{r}_i = \mathbf{x}_i - \mathbf{x}_{cg}, \quad (191)$$

and consequently:

$$\sum_i \mathbf{r}_i w_i = 0. \quad (192)$$

The forces and moments $\{\mathbf{F}_u, \mathbf{M}_u\}$ defined by the user in the reference node \mathbf{p} can be transferred into an equivalent system consisting of the force $\mathbf{F} = \mathbf{F}_u$ and the moment $\mathbf{M} = (\mathbf{p} - \mathbf{x}_{cg}) \times \mathbf{F}_u + \mathbf{M}_u$ in the center of gravity. Now, it can be shown by use of the above relations that the system consisting of

$$\mathbf{F}_i := \mathbf{F}_{iF} + \mathbf{F}_{iM}, \quad (193)$$

where

$$\mathbf{F}_{iF} = \mathbf{F} w_i \quad (194)$$

and

$$\mathbf{F}_{iM} = \frac{(\mathbf{M} \times \mathbf{r}'_i) w_i}{\sum_i \|\mathbf{r}'_i\|^2 w_i} \quad (195)$$

using the definition

$$\mathbf{r}'_i := \mathbf{r}_i - \frac{(\mathbf{r}_i \cdot \mathbf{M}) \mathbf{M}}{\|\mathbf{M}\|^2} =: \mathbf{r}_i - \mathbf{r}''_i \quad (196)$$

is equivalent to the system $\{\mathbf{F}, \mathbf{M}\}$ in the center of gravity. The vector \mathbf{r}'_i is the orthogonal projection of \mathbf{r}_i on a plane perpendicular to \mathbf{M} . Notice that $\mathbf{r}'_i \cdot \mathbf{M} = 0$ and $\mathbf{r}''_i \times \mathbf{M} = 0$.

The proof is done by calculating $\sum_i \mathbf{F}_i$ and $\sum_i \mathbf{r}_i \times \mathbf{F}_i$ and using the relationship $\mathbf{a} \times (\mathbf{b} \times \mathbf{c}) = (\mathbf{a} \cdot \mathbf{c}) \mathbf{b} - (\mathbf{a} \cdot \mathbf{b}) \mathbf{c}$. One obtains:

$$\sum_i \mathbf{F}_{iF} = \mathbf{F} \sum_i w_i = \mathbf{F}. \quad (197)$$

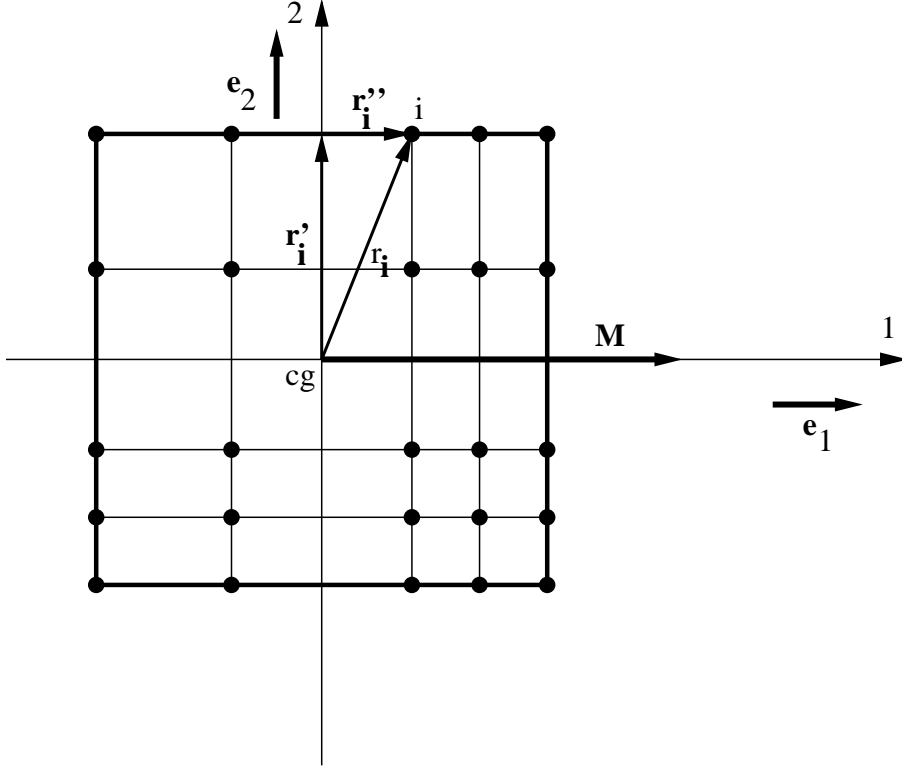

Figure 126: Data used for the distribution of a bending moment

$$\sum_i \mathbf{r}_i \times \mathbf{F}_{iF} = \sum_i \mathbf{r}_i \times \mathbf{F} w_i = \sum_i w_i \mathbf{r}_i \times \mathbf{F} = 0. \quad (198)$$

$$\sum_i \mathbf{F}_{iM} = \sum_i \frac{(\mathbf{M} \times \mathbf{r}'_i) w_i}{\sum_i \|\mathbf{r}'_i\|^2 w_i} = \frac{\sum_i (\mathbf{M} \times \mathbf{r}_i) w_i}{\sum_i \|\mathbf{r}'_i\|^2 w_i} = 0. \quad (199)$$

$$\sum_i \mathbf{r}_i \times \mathbf{F}_{iM} = \frac{\sum_i (\mathbf{r}_i \cdot \mathbf{r}'_i) \mathbf{M} w_i}{\sum_i \|\mathbf{r}'_i\|^2 w_i} - \frac{\sum_i (\mathbf{r}_i \cdot \mathbf{M}) \mathbf{r}'_i w_i}{\sum_i \|\mathbf{r}'_i\|^2 w_i}. \quad (200)$$

The last equation deserves some further analysis. The first term on the right hand side amounts to \mathbf{M} since $\mathbf{r}_i \cdot \mathbf{r}'_i = \mathbf{r}'_i \cdot \mathbf{r}'_i$. For the analysis of the second term a cartesian coordinate system consisting of the unit vectors $\mathbf{e}_1 \parallel \mathbf{M}$, \mathbf{e}_2 and \mathbf{e}_3 is created (cf. Figure 126 for a 2-D surface in the 1-2-plane). The numerator of the second term amounts to:

$$\begin{aligned}
\sum_i (\mathbf{r}_i \cdot \mathbf{M}) \mathbf{r}'_i w_i &= \sum_i (\mathbf{r}''_i \cdot \mathbf{M}) \mathbf{r}'_i w_i \\
&= \sum_i r''_i M \mathbf{r}'_i w_i \\
&= \sum_i r''_i M r'_{i2} \mathbf{e}_2 w_i + \sum_i r''_i M r'_{i3} \mathbf{e}_3 w_i \\
&= M \mathbf{e}_2 \sum_i r''_i r'_{i2} w_i + M \mathbf{e}_3 \sum_i r''_i r'_{i3} w_i. \tag{201}
\end{aligned}$$

These terms are zero (setting $r''_i = r'_{i1}$) if $\sum_i r'_{i1} r'_{i2} w_i = 0$ and $\sum_i r'_{i1} r'_{i3} w_i = 0$ i.e. if the cartesian coordinate system is parallel to the principal axes of inertia based on the weights w_i . Consequently, for Eq. (195) to be valid, \mathbf{e}_1 , \mathbf{e}_2 and \mathbf{e}_3 have to be aligned with the principal axes of inertia! The equivalent force and moment in the center of gravity are subsequently decomposed along these axes.

Defining $\mathbf{F} = F_j \mathbf{e}_j$ and $\mathbf{M} = M_j \mathbf{e}_j$ one can write:

$$\mathbf{F}_i = F_j \mathbf{a}_j + M_j \mathbf{b}_j, \tag{202}$$

where

$$\mathbf{a}_j := \mathbf{e}_j w_i \tag{203}$$

and

$$\mathbf{b}_j := \frac{(\mathbf{e}_j \times \mathbf{r}'_i) w_i}{\sum_i \|\mathbf{r}'_i\|^2 w_i}. \tag{204}$$

Notice that the formula for the moments is the discrete equivalent of the well-known formulas $\sigma = My/I$ for bending moments and $\tau = Tr/J$ for torques in beams [76].

Now, an equivalent formulation to Equation (202) for the user defined force \mathbf{F}_u and moment \mathbf{M}_u is sought. In component notation Equation (202) runs:

$$(F_i)_k = F_j a_{jk} + M_j b_{jk}. \tag{205}$$

Defining vectors $\boldsymbol{\alpha}_k$ and $\boldsymbol{\beta}_k$ such that $(\boldsymbol{\alpha}_k)_j = a_{jk}$ and $(\boldsymbol{\beta}_k)_j = b_{jk}$ this can be written as:

$$(\mathbf{F}_i)_k = \boldsymbol{\alpha}_k \cdot \mathbf{F} + \boldsymbol{\beta}_k \cdot \mathbf{M} \tag{206}$$

or

$$(\mathbf{F}_i)_k = \boldsymbol{\alpha}_k \cdot \mathbf{F}_u + \boldsymbol{\beta}_k \cdot (\mathbf{M}_u + \mathbf{r} \times \mathbf{F}_u), \tag{207}$$

where $\mathbf{r} := \mathbf{p} - \mathbf{x}_{cg}$. This is a linear function of \mathbf{F}_u and \mathbf{M}_u :

$$(\mathbf{F}_i)_k = \gamma_k \cdot \mathbf{F}_u + \beta_k \cdot \mathbf{M}_u \quad (208)$$

where

$$(\gamma_k)_m = (\alpha_k)_m + (\beta_k)_q e_{qpm} r_p. \quad (209)$$

The coefficients γ_k and β_k in Equation (208) are stored at the beginning of the calculation for repeated use in the steps (the forces and moments can change from step to step). Notice that the components of \mathbf{F}_u and \mathbf{M}_u have to be calculated in the local coupling surface coordinate system, whereas the result $(\mathbf{F}_i)_k$ applies in the global cartesian system.

If an orientation is defined on the *COUPLING card the force and moment contributions are first transferred into the global cartesian system before applying the above procedure. Right now, only cartesian local systems are allowed for distributing coupling.

6.7.4 Mathematical description of a knot

Knots are used in the expansion of 1d and 2d elements into three dimensions, see Sections 6.2.14 and 6.2.33.

The mathematical description of a knot was inspired by the polar decomposition theorem stating that the deformed state $d\mathbf{x}$ of an infinitesimal vector $d\mathbf{X}$ in a continuum can be decomposed into a stretch followed by a rotation [23],[25]:

$$d\mathbf{x} = \mathbf{F} \cdot d\mathbf{X} = \mathbf{R} \cdot \mathbf{U} \cdot d\mathbf{X}, \quad (210)$$

where \mathbf{F} is the deformation gradient, \mathbf{R} is the rotation tensor and \mathbf{U} is the right stretch tensor. Applying this to a finite vector extending from the center of gravity of a knot \mathbf{q} to any expanded node \mathbf{p}_i yields

$$(\mathbf{p}_i + \mathbf{u}_i) - (\mathbf{q} + \mathbf{w}) = \mathbf{R} \cdot \mathbf{U} \cdot (\mathbf{p}_i - \mathbf{q}), \quad (211)$$

where \mathbf{u}_i and \mathbf{w} are the deformation of the node and the deformation of the center of gravity, respectively. This can be rewritten as

$$\mathbf{u}_i = \mathbf{w} + (\mathbf{R} \cdot \mathbf{U} - \mathbf{I}) \cdot (\mathbf{p}_i - \mathbf{q}), \quad (212)$$

showing that the deformation of a node belonging to a knot can be decomposed in a translation of the knot's center of gravity followed by a stretch and a rotation of the connecting vector. Although this vector has finite dimensions, its size is usually small compared to the overall element length since it corresponds to the thickness of the shells or beams. In three dimensions \mathbf{U} corresponds to a symmetric 3 x 3 matrix (6 degrees of freedom) and \mathbf{R} to an orthogonal 3 x 3 matrix (3 degrees of freedom) yielding a total of 9 degrees of freedom. Notice that the stretch tensor can be written as a function of its principal values λ_i and principal directions \mathbf{N}^i as follows:

$$\mathbf{U} = \sum_i \lambda_i \mathbf{N}^i \otimes \mathbf{N}^i. \quad (213)$$

Beam knot The expansion of a single beam node leads to a planar set of nodes. Therefore, the stretch of a knot based on this expansion is reduced to the stretch along the two principal directions in that plane. The stretch in the direction of the beam axis is not relevant. Let us assume that \mathbf{T}_1 is a unit vector tangent to the local beam axis and $\mathbf{E}_1, \mathbf{E}_2$ are two unit vectors in the expansion plane such that $\mathbf{E}_1 \cdot \mathbf{E}_2 = 0$ and $\mathbf{E}_1 \times \mathbf{E}_2 = \mathbf{T}_1$. Then, the stretch in the plane can be characterized by vectors \mathbf{T}_2 and \mathbf{T}_3 along its principal directions:

$$\mathbf{T}_2 = \xi(\mathbf{E}_1 \cos \varphi + \mathbf{E}_2 \sin \varphi) \quad (214)$$

$$\mathbf{T}_3 = \eta(-\mathbf{E}_1 \sin \varphi + \mathbf{E}_2 \cos \varphi) \quad (215)$$

leading to three stretch degrees of freedom φ , ξ and η . φ is the angle \mathbf{T}_2 makes with \mathbf{E}_1 , ξ is the stretch along \mathbf{T}_2 and η is the stretch along \mathbf{T}_3 . The right stretch tensor \mathbf{U} can now be written as:

$$\begin{aligned} \mathbf{U} &= \mathbf{T}_1 \otimes \mathbf{T}_1 + \mathbf{T}_2 \otimes \mathbf{T}_2 + \mathbf{T}_3 \otimes \mathbf{T}_3 \\ &= \mathbf{T}_1 \otimes \mathbf{T}_1 + (\xi^2 \cos^2 \varphi + \eta^2 \sin^2 \varphi) \mathbf{E}_1 \otimes \mathbf{E}_1 + (\xi^2 \sin^2 \varphi + \eta^2 \cos^2 \varphi) \mathbf{E}_2 \otimes \mathbf{E}_2 \\ &\quad + (\xi^2 - \eta^2) \cos \varphi \sin \varphi (\mathbf{E}_1 \otimes \mathbf{E}_2 + \mathbf{E}_2 \otimes \mathbf{E}_1). \end{aligned} \quad (216)$$

The rotation vector reads in component notation

$$R_{ij} = \delta_{ij} \cos \theta + \sin \theta e_{ikj} n_k + (1 - \cos \theta) n_i n_j. \quad (217)$$

Here, $\boldsymbol{\theta}$ is a vector along the rotation axis satisfying $\boldsymbol{\theta} = \theta \mathbf{n}$, $\|\mathbf{n}\| = 1$. Assuming that at some point in the calculation the knot is characterized by $(\mathbf{w}_0, \boldsymbol{\theta}_0, \varphi_0, \xi_0, \eta_0)$, a change $(\Delta \mathbf{w}, \Delta \boldsymbol{\theta}, \Delta \varphi, \Delta \xi, \Delta \eta)$ leads to (cf. Equation (212)):

$$\mathbf{u}_0 + \Delta \mathbf{u} = \mathbf{w}_0 + \Delta \mathbf{w} + [\mathbf{R}(\boldsymbol{\theta}_0 + \Delta \boldsymbol{\theta}) \cdot \mathbf{U}(\varphi_0 + \Delta \varphi, \xi_0 + \Delta \xi, \eta_0 + \Delta \eta) - \mathbf{I}] \cdot (\mathbf{p} - \mathbf{q}). \quad (218)$$

Taylor expansion of \mathbf{R} :

$$\mathbf{R}(\boldsymbol{\theta}_0 + \Delta \boldsymbol{\theta}) = \mathbf{R}(\boldsymbol{\theta}_0) + \left. \frac{\partial \mathbf{R}}{\partial \boldsymbol{\theta}} \right|_{\boldsymbol{\theta}_0} \cdot \Delta \boldsymbol{\theta} + \dots, \quad (219)$$

and similar for \mathbf{U} and keeping linear terms only leads to the following equation:

$$\begin{aligned}
\Delta \mathbf{u} = & \Delta \mathbf{w} + \left[\frac{\partial \mathbf{R}}{\partial \boldsymbol{\theta}} \Big|_{\boldsymbol{\theta}_0} \cdot \Delta \boldsymbol{\theta} \right] \cdot \mathbf{U}(\varphi_0, \xi_0, \eta_0) \cdot (\mathbf{p} - \mathbf{q}) \\
& + \mathbf{R}(\boldsymbol{\theta}_0) \cdot \left[\frac{\partial \mathbf{U}}{\partial \varphi} \Big|_{\varphi_0} \Delta \varphi + \frac{\partial \mathbf{U}}{\partial \xi} \Big|_{\xi_0} \Delta \xi + \frac{\partial \mathbf{U}}{\partial \eta} \Big|_{\eta_0} \Delta \eta \right] \cdot (\mathbf{p} - \mathbf{q}) \\
& + \mathbf{w}_0 + [\mathbf{R}(\boldsymbol{\theta}_0) \cdot \mathbf{U}(\varphi_0, \xi_0, \eta_0) - \mathbf{I}] \cdot (\mathbf{p} - \mathbf{q}) - \mathbf{u}_0. \tag{220}
\end{aligned}$$

The latter equation is a inhomogeneous linear equation linking the change in displacements of an arbitrary node belonging to a knot to the change in the knot parameters (translation, rotation and stretch). This equation is taken into account at the construction phase of the governing equations. In that way the expanded degrees of freedom, being dependent, never show up in the equations to solve.

Shell knot The expansion of a shell node leads to a set of nodes lying on a straight line. Therefore, the stretch tensor \mathbf{U} is reduced to the stretch along this line. Let \mathbf{T}_1 be a unit vector parallel to the expansion and \mathbf{T}_2 and \mathbf{T}_3 unit vectors such that $\mathbf{T}_2 \cdot \mathbf{T}_3 = 0$ and $\mathbf{T}_1 \times \mathbf{T}_2 = \mathbf{T}_3$. Then \mathbf{U} can be written as:

$$\mathbf{U} = \alpha \mathbf{T}_1 \otimes \mathbf{T}_1 + \mathbf{T}_2 \otimes \mathbf{T}_2 + \mathbf{T}_3 \otimes \mathbf{T}_3 \tag{221}$$

leading to one stretch parameter α . Since the stretch along \mathbf{T}_2 and \mathbf{T}_3 is immaterial, Equation (221) can also be replaced by

$$\mathbf{U} = \alpha \mathbf{T}_1 \otimes \mathbf{T}_1 + \alpha \mathbf{T}_2 \otimes \mathbf{T}_2 + \alpha \mathbf{T}_3 \otimes \mathbf{T}_3 = \alpha \mathbf{I} \tag{222}$$

representing an isotropic expansion. Equation (220) can now be replaced by

$$\begin{aligned}
\Delta \mathbf{u} = & \Delta \mathbf{w} + \alpha_0 \left[\frac{\partial \mathbf{R}}{\partial \boldsymbol{\theta}} \Big|_{\boldsymbol{\theta}_0} \cdot \Delta \boldsymbol{\theta} \right] \cdot (\mathbf{p} - \mathbf{q}) + \Delta \alpha \mathbf{R}(\boldsymbol{\theta}_0) \cdot (\mathbf{p} - \mathbf{q}) \\
& + \mathbf{w}_0 + [\alpha_0 \mathbf{R}(\boldsymbol{\theta}_0) - \mathbf{I}] \cdot (\mathbf{p} - \mathbf{q}) - \mathbf{u}_0. \tag{223}
\end{aligned}$$

Consequently, a knot resulting from a shell expansion is characterized by 3 translational degrees of freedom, 3 rotational degrees of freedom and 1 stretch degree of freedom.

Arbitrary knot A knot generally consists of one or more expansions of one and the same node, leading to a cloud of nodes \mathbf{p}_i . In the previous two sections knots were considered consisting of the expanded nodes of just one beam element or just one shell element. Generally, a knot will be the result of several beam and shell elements leading to a cloud of nodes in three-dimensional space. In order to determine the dimensionality of this cloud the first and second order moments of inertia are calculated leading to the location of the center of gravity and the

second order moments about the center of gravity. The principal values of the second order moment matrix can be used to catalogue the dimensionality of the nodal cloud: if the lowest two principal values are zero the dimensionality is one (i.e. the nodes lie on a line as for the shell knot), if only the lowest one is zero the dimensionality is two (i.e. the nodes lie in a plane as for a beam knot). Else, the dimensionality is three. If the dimensionality corresponds to the highest dimensionality of the single elements involved, the formulation corresponding to that dimensionality is used.

If the dimensionality of the nodal cloud exceeds the highest dimensionality of the single elements, the shell knot formulation (isotropic expansion) is used. The reason for this is that the knot is supposed to be physically rigid, i.e. the relative angular position of the constituting elements should not change during deformation. Using the beam knot formulation leads to anisotropic stretching, which changes this relative angular position.

6.7.5 Node-to-Face Penalty Contact

General considerations Contact is a strongly nonlinear kind of boundary condition, preventing bodies to penetrate each other. The contact definitions implemented in CalculiX are a node-to-face penalty method, a face-to-face penalty method and a mortar method, all of which are based on a pairwise interaction of surfaces. They cannot be mixed in one and the same input deck. In the present section the node-to-face penalty method is explained. For details on the penalty method the reader is referred to [105] and [47].

Each pair of interacting surfaces consists of a dependent surface and an independent surface. The dependent surface (= slave) may be defined based on nodes or element faces, the independent surface (= master) must consist of element faces (Figure 127). The element faces within one independent surface must be such, that any edge of any face has at most one neighboring face. Usually, the mesh on the dependent side should be at least as fine as on the independent side. As many pairs can be defined as needed. A contact pair is defined by the keyword card *CONTACT PAIR.

If the elements adjacent to the slave surface are quadratic elements (e.g. C3D20, C3D10 or C3D15), convergence may be slower. This especially applies to elements having quadrilateral faces in the slave surface. A uniform pressure on a quadratic (8-node) quadrilateral face leads to compressive forces in the midnodes and tensile forces in the vertex nodes [23] (with weights of 1/3 and -1/12, respectively). The tensile forces in the corner nodes usually lead to divergence if this node belongs to a node-to-face contact element. Therefore, in CalculiX the weights are modified into 24/100 and 1/100, respectively. In general, node-to-face contact is not recommended for quadratic elements. Instead, face-to-face penalty contact or mortar contact should be used.

In CalculiX, penalty contact is modeled by the generation of (non)linear spring elements. To this end, for each node on the dependent surface, a face on the independent surface is localized such that it contains the orthogonal projection of the node. If such a face is found a nonlinear spring element is

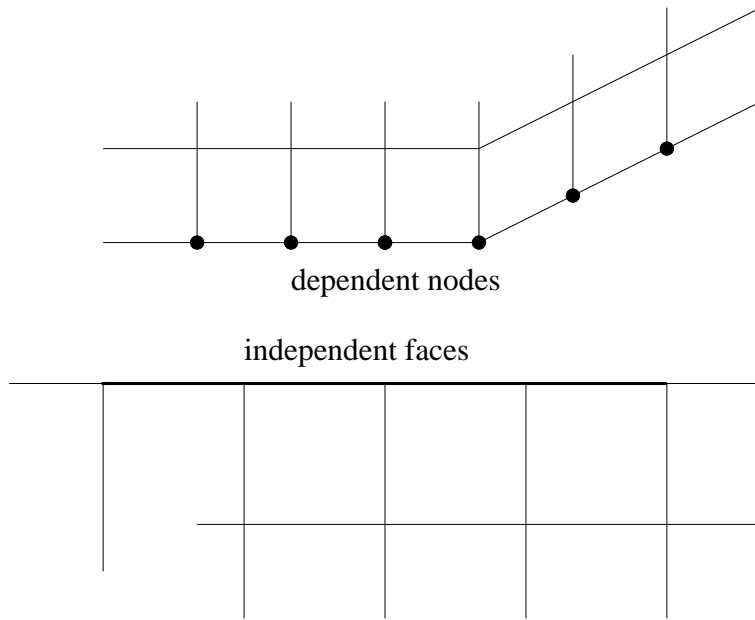

Figure 127: Definition of the dependent nodal surface and the independent element face surface

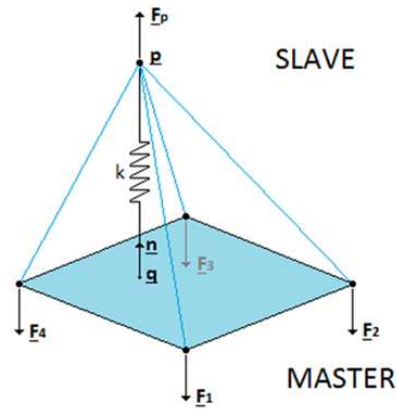

Figure 128: Creation of a node-to-face penalty contact element

generated consisting of the dependent node and all vertex nodes belonging to the independent face (Figure 128). Depending of the kind of face the contact spring element contains 4, 5, 7 or 9 nodes. The properties of the spring are defined by a *SURFACE INTERACTION definition, whose name must be specified on the *CONTACT PAIR card.

The user can determine how often during the calculation the pairing of the dependent nodes with the independent faces takes place. If the user specifies the parameter SMALL SLIDING on the *CONTACT PAIR card, the pairing is done once per increment. If this parameter is not selected, the pairing is checked every iteration for all iterations below 9, for iterations 9 and higher the contact elements are frozen to improve convergence. Deactivating SMALL SLIDING is useful if the sliding is particularly large.

The *SURFACE INTERACTION keyword card is very similar to the *MATERIAL card: it starts the definition of interaction properties in the same way a *MATERIAL card starts the definition of material properties. Whereas material properties are characterized by cards such as *DENSITY or *ELASTIC, interaction properties are denoted by the *SURFACE BEHAVIOR and the *FRICTION card. All cards beneath a *SURFACE INTERACTION card are interpreted as belonging to the surface interaction definition until a keyword card is encountered which is not a surface interaction description card. At that point, the surface interaction description is considered to be finished. Consequently, an interaction description is a closed block in the same way as a material description, Figure 3.

The *SURFACE BEHAVIOR card defines the linear (actually quasi bilinear as illustrated by Figure 130), exponential, or piecewise linear normal (i.e. locally perpendicular onto the master surface) behavior of the spring element. The pressure p exerted on the independent face of a contact spring element with exponential behavior is given by

$$p = p_0 \exp(\beta d), \quad (224)$$

where p_0 is the pressure at zero clearance, β is a coefficient and d is the overclosure (penetration of the slave node into the master side; a negative penetration is a clearance). Instead of having to specify β , which lacks an immediate physical significance, the user is expected to specify c_0 which is the clearance at which the pressure is 1 % of p_0 . From this β can be calculated:

$$\beta = \frac{\ln 100}{c_0}. \quad (225)$$

The pressure curve for $p_0 = 1$ and $c_0 = 0.5$ looks like in Figure 129. A large value of c_0 leads to soft contact, i.e. large penetrations can occur, hard contact is modeled by a small value of c_0 . Hard contact leads to slower convergence than soft contact. If the distance of the slave node to the master surface exceeds c_0 no contact spring element is generated. For exponential behavior the user has to specify c_0 and p_0 underneath the *SURFACE BEHAVIOR card.

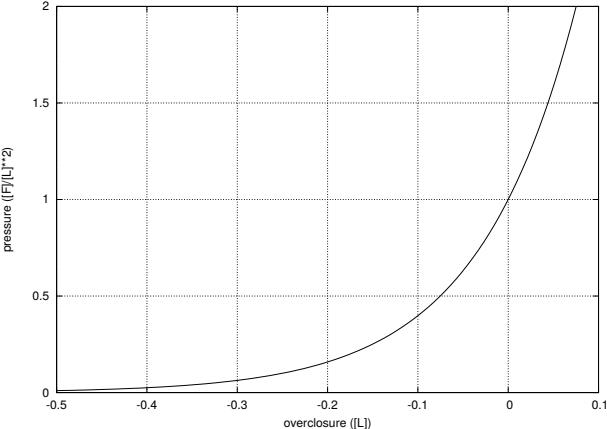

Figure 129: Exponential pressure-overclosure relationship

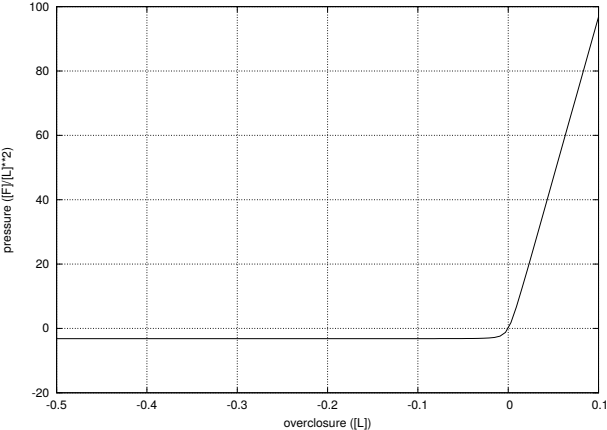

Figure 130: Linear pressure-overclosure relationship

In case of a linear contact spring the pressure-overclosure relationship is given by

$$p = Kd \left[\frac{1}{2} + \frac{1}{\pi} \tan^{-1} \left(\frac{d}{\epsilon} \right) \right], \quad (226)$$

where ϵ is a small number. The term in square brackets makes sure that the value of p is very small for $d \leq 0$. In general, a linear contact spring formulation will converge more easily than an exponential behavior. The pressure curve for $K = 10^3$ and $\epsilon = 10^{-2}$ looks like in Figure 130. A large value of K leads to hard contact. To obtain good results K should typically be 5 to 50 times the E-modulus of the adjacent materials. If one knows the roughness of the contact surfaces in the form of a peak-to-valley distance d_{pv} and the maximum pressure p_{max} to expect, one might estimate the spring constant by $K = p_{max}/d_{pv}$. The units of K are [Force]/[Length]³.

Notice that for a large negative overclosure a tension σ_∞ results (for $d \rightarrow -\infty$), equal to $K\epsilon/\pi$. The value of σ_∞ has to be specified by the user. A good value is about 0.25 % of the maximum expected stress in the model. CalculiX calculates ϵ from σ_∞ and K .

For a linear contact spring the distance beyond which no contact spring element is generated is defined by $c_0\sqrt{\text{spring area}}$ if the spring area exceeds zero, and 10^{-10} otherwise. The default for c_0 is 10^{-3} (dimensionless) but may be changed by the user. For a linear pressure-overclosure relationship the user has to specify K and σ_∞ underneath the *SURFACE BEHAVIOR card. c_0 is optional, and may be entered as the third value on the same line.

The pressure-overclosure behavior can also be defined as a piecewise linear function (PRESSURE-OVERCLOSURE=TABULAR). In this way the user can use experimental data to define the curve. For a tabular spring the distance beyond which no contact spring element is generated is defined by $10^{-3}\sqrt{\text{spring area}}$ if the spring area exceeds zero, and 10^{-10} otherwise. For tabular behavior the user has to enter pressure-overclosure pairs, one on a line.

The normal spring force is defined as the pressure multiplied by the spring area. The spring area is assigned to the slave nodes and defined by 1/4 (linear quadrilateral faces) or 1/3 (linear triangular faces) of the slave faces the slave node belongs to. For quadratic quadrilateral faces the weights are 24/100 for middle nodes and 1/100 for corner nodes. For quadratic triangular faces these weights are 1/3 and 0, respectively.

The tangential spring force is defined as the shear stress multiplied by the spring area. The shear stress is a function of the relative displacement $\|\mathbf{t}\|$ between the slave node and the master face. This function is shown in Figure 131. It consists of a stick range, in which the shear stress is a linear function of the relative tangential displacement, and a slip range, for which the shear stress is a function of the local pressure only. User input consists of the friction coefficient μ which is dimensionless and usually takes values between 0.1 and 0.5 and the stick slope λ which has the dimension of force per unit of volume and should be chosen about 100 times smaller than the spring constant.

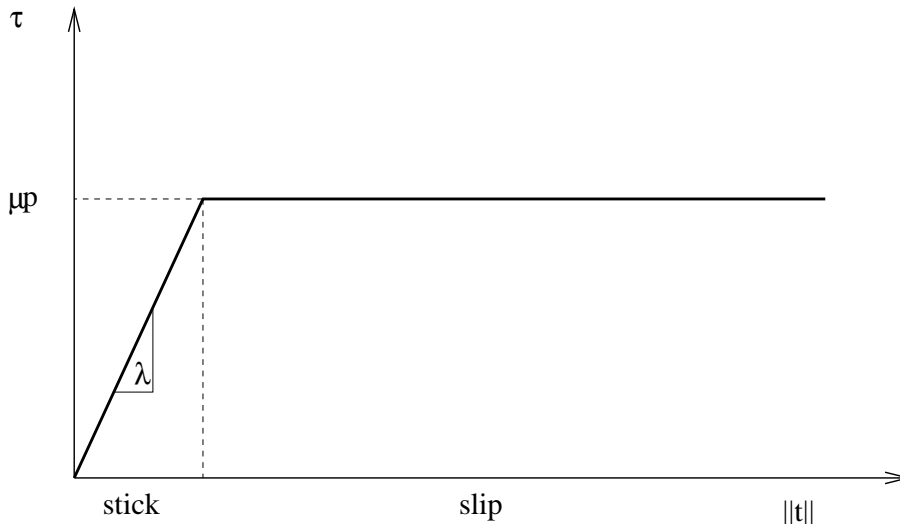

Figure 131: Shear stress versus relative tangential displacement

The friction can be redefined in all but the first step by the `*CHANGE FRICTION` keyword card. In the same way contact pairs can be activated or deactivated in all but the first step by using the `*MODEL CHANGE` card.

If CalculiX detects an overlap of the contacting surfaces at the start of a step, the overlap is completely taken into account at the start of the step for a dynamic calculation (`*DYNAMIC` or `*MODAL DYNAMIC`) whereas it is linearly ramped for a static calculation (`*STATIC`).

Finally a few useful rules if you experience convergence problems:

- Deactivate NLGEOM (i.e. do not use NLGEOM on the `*STEP` card).
- Try `SMALL SLIDING` first, and then large sliding, if applicable.
- Try a linear pressure-overclosure relationship first (instead of exponential), with a stiffness constant about 5 to 50 times Young's modulus of the adjacent materials.
- Define your slave surface based on faces, not on nodes. This can be especially helpful if you use quadratic elements.
- Make sure that the mesh density on the slave side is at least as fine as on the master side, preferably finer.
- Deactivate friction first.

Notice that the parameter `CONTACT ELEMENTS` on the `*NODE FILE`, `*EL FILE`, `NODE OUTPUT`, or `*ELEMENT OUTPUT` card stores the contact elements which have been generated in each iteration as a set with the name

contactelements_st α _in β _at γ _it δ (where α is the step number, β the increment number, γ the attempt number and δ the iteration number) in a file jobname.cel. When opening the frd file with CalculiX GraphiX this file can be read with the command “read jobname.cel inp” and visualized by plotting the elements in the appropriate set. These elements are the contact spring elements and connect the slave nodes with the corresponding master surfaces. In case of contact these elements will be very flat. Moving the parts apart (by a translation) will improve the visualization. Using the screen up and screen down key one can check how contact evolved during the calculation. Looking at where contact elements have been generated may help localizing the problem in case of divergence.

The number of contact elements generated is also listed in the screen output for each iteration in which contact was established anew, i.e. for each iteration ≤ 8 if the SMALL SLIDING parameter was not used on the *CONTACT PAIR card, else only in the first iteration of each increment.

Normal contact stiffness A node-to-face contact element consists of a slave node connected to a master face (cf. Figure 128). Therefore, it consists of $1 + n_m$ nodes, where n_m is the number of nodes belonging to the master face. The stiffness matrix of a finite element is the derivative of the internal forces in each of the nodes w.r.t. the displacements of each of the nodes. Therefore, we need to determine the internal force in the nodes.

Denoting the position of the slave node by \mathbf{p} and the position of the projection onto the master face by \mathbf{q} , the vector connecting both satisfies:

$$\mathbf{r} = \mathbf{p} - \mathbf{q}. \quad (227)$$

The clearance r at this position can be described by

$$r = \mathbf{r} \cdot \mathbf{n} \quad (228)$$

where \mathbf{n} is the local normal on the master face. Denoting the nodes belonging to the master face by $\mathbf{q}_i, i = 1, n_m$ and the local coordinates within the face by ξ and η , one can write:

$$\mathbf{q} = \sum_j \varphi_j(\xi, \eta) \mathbf{q}_j, \quad (229)$$

$$\mathbf{m} = \frac{\partial \mathbf{q}}{\partial \xi} \times \frac{\partial \mathbf{q}}{\partial \eta} \quad (230)$$

and

$$\mathbf{n} = \frac{\mathbf{m}}{\|\mathbf{m}\|}. \quad (231)$$

\mathbf{m} is the Jacobian vector on the surface. The internal force on node p is now given by

$$\mathbf{F}_p = -f(r) \mathbf{n} a_p, \quad (232)$$

where f is the pressure versus clearance function selected by the user and a_p is the slave area for which node p is representative. If the slave node belongs to N contact slave faces i with area A_i , this area may be calculated as:

$$a_p = \sum_{i=1}^N A_i/n_{si}. \quad (233)$$

The minus sign in Equation (232) stems from the fact that the internal force is minus the external force (the external force is the force the master face exerts on the slave node). Replacing the normal in Equation (232) by the Jacobian vector divided by its norm and taking the derivative w.r.t. \mathbf{u}_i , where i can be the slave node or any node belonging to the master face one obtains:

$$\frac{1}{a_p} \frac{\partial \mathbf{F}_p}{\partial \mathbf{u}_i} = -\frac{\mathbf{m}}{\|\mathbf{m}\|} \otimes \frac{\partial f}{\partial r} \left[\frac{\partial}{\partial \mathbf{u}_i} \left(\frac{\mathbf{m}}{\|\mathbf{m}\|} \cdot \mathbf{r} \right) \right] - \frac{f}{\|\mathbf{m}\|} \frac{\partial \mathbf{m}}{\partial \mathbf{u}_i} + \frac{f}{\|\mathbf{m}\|^2} \mathbf{m} \otimes \frac{\partial \|\mathbf{m}\|}{\partial \mathbf{u}_i}. \quad (234)$$

Since

$$\frac{\partial}{\partial \mathbf{u}_i} \left(\frac{\mathbf{m}}{\|\mathbf{m}\|} \cdot \mathbf{r} \right) = \frac{1}{\|\mathbf{m}\|} \mathbf{r} \cdot \frac{\partial \mathbf{m}}{\partial \mathbf{u}_i} - \frac{r}{\|\mathbf{m}\|} \frac{\partial \|\mathbf{m}\|}{\partial \mathbf{u}_i} + \frac{\mathbf{m}}{\|\mathbf{m}\|} \cdot \frac{\partial \mathbf{r}}{\partial \mathbf{u}_i}, \quad (235)$$

the above equation can be rewritten as

$$\begin{aligned} \frac{1}{a_p} \frac{\partial \mathbf{F}_p}{\partial \mathbf{u}_i} = & - \left(\frac{\partial f}{\partial r} \frac{1}{\|\mathbf{m}\|^2} \right) \mathbf{m} \otimes \left[\mathbf{r} \cdot \frac{\partial \mathbf{m}}{\partial \mathbf{u}_i} + \mathbf{m} \cdot \frac{\partial \mathbf{r}}{\partial \mathbf{u}_i} - r \frac{\partial \|\mathbf{m}\|}{\partial \mathbf{u}_i} \right] \\ & + \frac{f}{\|\mathbf{m}\|} \left[\mathbf{n} \otimes \frac{\partial \|\mathbf{m}\|}{\partial \mathbf{u}_i} - \frac{\partial \mathbf{m}}{\partial \mathbf{u}_i} \right]. \end{aligned} \quad (236)$$

Consequently, the derivatives which are left to be determined are $\partial \mathbf{m}/\partial \mathbf{u}_i$, $\partial \mathbf{r}/\partial \mathbf{u}_i$ and $\partial \|\mathbf{m}\|/\partial \mathbf{u}_i$.

The derivative of \mathbf{m} is obtained by considering Equation (230), which can also be written as:

$$\mathbf{m} = \sum_j \sum_k \frac{\partial \varphi_j}{\partial \xi} \frac{\partial \varphi_k}{\partial \eta} [\mathbf{q}_j \times \mathbf{q}_k]. \quad (237)$$

Derivation yields (notice that ξ and η are a function of \mathbf{u}_i , and that $\partial \mathbf{q}_i/\partial \mathbf{u}_j = \delta_{ij} \mathbf{I}$):

$$\begin{aligned} \frac{\partial \mathbf{m}}{\partial \mathbf{u}_i} = & \left[\frac{\partial^2 \mathbf{q}}{\partial \xi^2} \times \frac{\partial \mathbf{q}}{\partial \eta} + \frac{\partial \mathbf{q}}{\partial \xi} \times \frac{\partial^2 \mathbf{q}}{\partial \xi \partial \eta} \right] \otimes \frac{\partial \xi}{\partial \mathbf{u}_i} \\ & + \left[\frac{\partial \mathbf{q}}{\partial \xi} \times \frac{\partial^2 \mathbf{q}}{\partial \eta} + \frac{\partial^2 \mathbf{q}}{\partial \xi \partial \eta} \times \frac{\partial \mathbf{q}}{\partial \eta} \right] \otimes \frac{\partial \eta}{\partial \mathbf{u}_i} \\ & + \sum_{j=1}^{n_m} \sum_{k=1}^{n_m} \left[\frac{\partial \varphi_j}{\partial \xi} \frac{\partial \varphi_k}{\partial \eta} - \frac{\partial \varphi_k}{\partial \xi} \frac{\partial \varphi_j}{\partial \eta} \right] (\mathbf{I} \times \mathbf{q}_k) \delta_{ij}, \quad i = 1, \dots, n_m; p \end{aligned} \quad (238)$$

The derivatives $\partial\xi/\partial\mathbf{u}_i$ and $\partial\eta/\partial\mathbf{u}_i$ on the right hand side are unknown and will be determined later on. They represent the change of ξ and η whenever any of the \mathbf{u}_i is changed, k being the slave node or any of the nodes belonging to the master face. Recall that the value of ξ and η is obtained by orthogonal projection of the slave node on the master face.

Combining Equations (227) and (229) to obtain \mathbf{r} , the derivative w.r.t. \mathbf{u}_i can be written as:

$$\frac{\partial\mathbf{r}}{\partial\mathbf{u}_i} = \delta_{ip}\mathbf{I} - \left[\frac{\partial\mathbf{q}}{\partial\xi} \otimes \frac{\partial\xi}{\partial\mathbf{u}_i} + \frac{\partial\mathbf{q}}{\partial\eta} \otimes \frac{\partial\eta}{\partial\mathbf{u}_i} + \varphi_i(1 - \delta_{ip})\mathbf{I} \right], \quad (239)$$

where p represents the slave node.

Finally, the derivative of the norm of a vector can be written as a function of the derivative of the vector itself:

$$\frac{\partial\|\mathbf{m}\|}{\partial\mathbf{u}_i} = \frac{\mathbf{m}}{\|\mathbf{m}\|} \cdot \frac{\partial\mathbf{m}}{\partial\mathbf{u}_i}. \quad (240)$$

The only derivatives left to determine are the derivatives of ξ and η w.r.t. \mathbf{u}_i . Requiring that \mathbf{q} is the orthogonal projection of \mathbf{p} onto the master face is equivalent to expressing that the connecting vector \mathbf{r} is orthogonal to the vectors $\partial\mathbf{q}/\partial\xi$ and $\partial\mathbf{q}/\partial\eta$, which are tangent to the master surface.

Now,

$$\mathbf{r} \perp \frac{\partial\mathbf{q}}{\partial\xi} \quad (241)$$

can be rewritten as

$$\mathbf{r} \cdot \frac{\partial\mathbf{q}}{\partial\xi} = 0 \quad (242)$$

or

$$\left[\mathbf{p} - \sum_i \varphi_i(\xi, \eta)\mathbf{q}_i \right] \cdot \left[\sum_i \frac{\partial\varphi_i}{\partial\xi}\mathbf{q}_i \right] = 0. \quad (243)$$

Differentiation of the above expression leads to

$$\begin{aligned} & \left[d\mathbf{p} - \sum_i \left(\frac{\partial\varphi_i}{\partial\xi}\mathbf{q}_i d\xi + \frac{\partial\varphi_i}{\partial\eta}\mathbf{q}_i d\eta + \varphi_i d\mathbf{q}_i \right) \right] \cdot \mathbf{q}_\xi + \\ & \mathbf{r} \cdot \left[\sum_i \left(\frac{\partial^2\varphi_i}{\partial\xi^2}\mathbf{q}_i d\xi + \frac{\partial^2\varphi_i}{\partial\xi\partial\eta}\mathbf{q}_i d\eta + \frac{\partial\varphi_i}{\partial\xi} d\mathbf{q}_i \right) \right] = 0 \end{aligned} \quad (244)$$

where \mathbf{q}_ξ is the derivative of \mathbf{q} w.r.t. ξ . The above equation is equivalent to:

$$\begin{aligned}
& (d\mathbf{p} - \mathbf{q}_\xi d\xi - \mathbf{q}_\eta d\eta - \sum_i \varphi_i d\mathbf{q}_i) \cdot \mathbf{q}_\xi + \\
& \mathbf{r} \cdot (\mathbf{q}_{\xi\xi} d\xi + \mathbf{q}_{\xi\eta} d\eta + \sum_i \frac{\partial \varphi_i}{\partial \xi} d\mathbf{q}_i) = 0.
\end{aligned} \tag{245}$$

One finally arrives at:

$$\begin{aligned}
& (-\mathbf{q}_\xi \cdot \mathbf{q}_\xi + \mathbf{r} \cdot \mathbf{q}_{\xi\xi}) d\xi + (-\mathbf{q}_\eta \cdot \mathbf{q}_\xi + \mathbf{r} \cdot \mathbf{q}_{\xi\eta}) d\eta = \\
& -\mathbf{q}_\xi \cdot d\mathbf{p} + \sum_i \left[(\varphi_i \mathbf{q}_\xi - \frac{\partial \varphi_i}{\partial \xi} \mathbf{r}) \cdot d\mathbf{q}_i \right]
\end{aligned} \tag{246}$$

and similarly for the tangent in η -direction:

$$\begin{aligned}
& (-\mathbf{q}_\xi \cdot \mathbf{q}_\eta + \mathbf{r} \cdot \mathbf{q}_{\xi\eta}) d\xi + (-\mathbf{q}_\eta \cdot \mathbf{q}_\eta + \mathbf{r} \cdot \mathbf{q}_{\eta\eta}) d\eta = \\
& -\mathbf{q}_\eta \cdot d\mathbf{p} + \sum_i \left[(\varphi_i \mathbf{q}_\eta - \frac{\partial \varphi_i}{\partial \eta} \mathbf{r}) \cdot d\mathbf{q}_i \right]
\end{aligned} \tag{247}$$

From this $\partial\xi/\partial\mathbf{q}_i$, $\partial\xi/\partial\mathbf{p}$ and so on can be determined. Indeed, suppose that all $d\mathbf{q}_i, i = 1, \dots, n_m = \mathbf{0}$ and $dp_y = dp_z = 0$. Then, the right hand side of the above equations reduces to $-\mathbf{q}_{\xi x} dp_x$ and $-\mathbf{q}_{\eta x} dp_x$ and one ends up with two equations in the two unknowns $\partial\xi/\partial p_x$ and $\partial\eta/\partial p_x$. Once $\partial\xi/\partial\mathbf{p}$ is determined one automatically obtains $\partial\xi/\partial\mathbf{u}_p$ since

$$\frac{\partial\xi}{\partial\mathbf{p}} = \frac{\partial\xi}{\partial\mathbf{u}_p}, \tag{248}$$

and similarly for the other derivatives. This concludes the derivation of $\partial\mathbf{F}_p/\partial\mathbf{u}_i$. Since

$$\mathbf{F}_j = -\varphi_j(\xi, \eta) \mathbf{F}_p, \tag{249}$$

one obtains:

$$\frac{\partial\mathbf{F}_j}{\partial\mathbf{u}_i} = -\mathbf{F}_p \otimes \left[\frac{\partial\varphi_j}{\partial\xi} \frac{\partial\xi}{\partial\mathbf{u}_i} + \frac{\partial\varphi_j}{\partial\eta} \frac{\partial\eta}{\partial\mathbf{u}_i} \right] - \varphi_j \frac{\partial\mathbf{F}_p}{\partial\mathbf{u}_i} \tag{250}$$

for the derivatives of the forces in the master nodes.

Tangent contact stiffness To find the tangent contact stiffness matrix, please look at Figure 132, part a). At the beginning of a concrete time increment, characterized by time t_n , the slave node at position \mathbf{p}_n corresponds to the projection vector \mathbf{q}_n on the master side. At the end of the time increment, characterized by time t_{n+1} both have moved to positions \mathbf{p}_{n+1} and \mathbf{q}_{n+1} ,

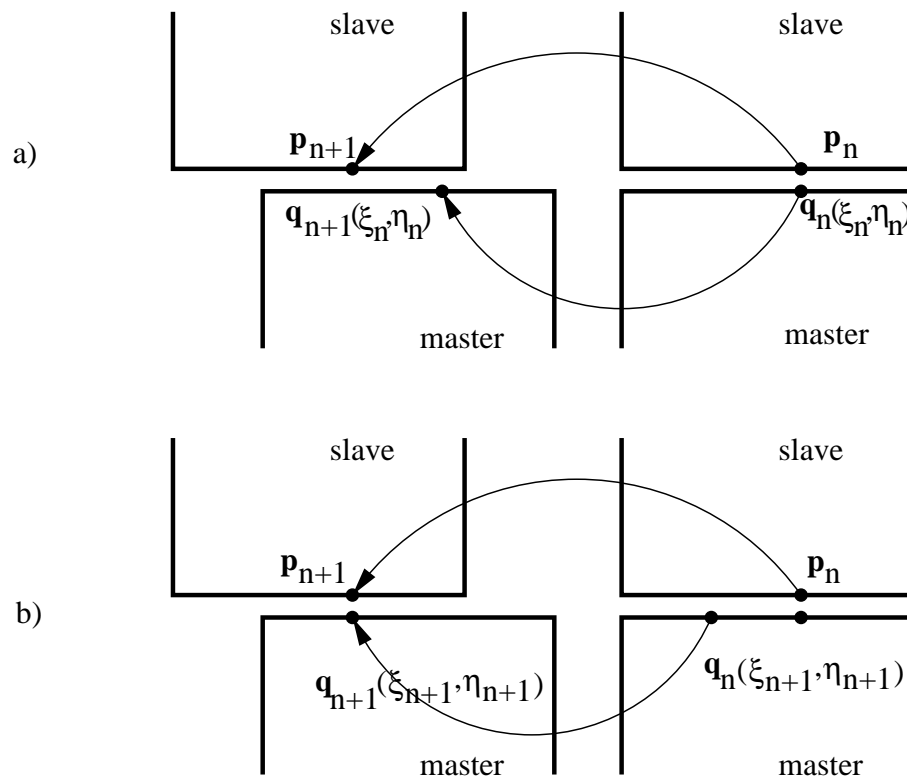

Figure 132: Visualization of the tangential differential displacements

respectively. The differential displacement between slave and master surface changed during this increment by the vector \mathbf{s} satisfying:

$$\mathbf{s} = (\mathbf{p}_{n+1} - \mathbf{q}_{n+1}) - (\mathbf{p}_n - \mathbf{q}_n). \quad (251)$$

Here, \mathbf{q}_{n+1} satisfies

$$\mathbf{q}_{n+1} = \sum_j \varphi_j(\xi_n^m, \eta_n^m) \mathbf{q}_{j_{n+1}}. \quad (252)$$

Since (the dependency of φ_j on ξ and η is dropped to simplify the notation)

$$\mathbf{p}_n = \mathbf{X} + \mathbf{u}_n, \quad (253)$$

$$\mathbf{p}_{n+1} = \mathbf{X} + \mathbf{u}_{n+1}, \quad (254)$$

$$\mathbf{q}_n = \sum_j \varphi_j [\mathbf{X}_j + (\mathbf{u}_j)_n], \quad (255)$$

$$\mathbf{q}_{n+1} = \sum_j \varphi_j [\mathbf{X}_j + (\mathbf{u}_j)_{n+1}], \quad (256)$$

this also amounts to

$$\mathbf{s} = \mathbf{u}_{n+1} - \sum_j \varphi_j (\mathbf{u}_j)_{n+1} - \left[\mathbf{u}_n - \sum_j \varphi_j (\mathbf{u}_j)_n \right]. \quad (257)$$

Notice that the local coordinates take the values of time t_n (the superscript m denotes iteration m within the increment). The differential tangential displacement now amounts to:

$$\mathbf{t} \equiv \mathbf{t}_{n+1} = \mathbf{t}_n + \mathbf{s} - s\mathbf{n}, \quad (258)$$

where

$$s = \mathbf{s} \cdot \mathbf{n}. \quad (259)$$

Derivation w.r.t. \mathbf{u}_i satisfies (straightforward differentiation):

$$\frac{\partial \mathbf{t}}{\partial \mathbf{u}_i} = \frac{\partial \mathbf{s}}{\partial \mathbf{u}_i} - \mathbf{n} \otimes \frac{\partial s}{\partial \mathbf{u}_i} - s \frac{\partial \mathbf{n}}{\partial \mathbf{u}_i} \quad (260)$$

$$\frac{\partial s}{\partial \mathbf{u}_i} = \frac{\mathbf{s}}{\|\mathbf{m}\|} \cdot \frac{\partial \mathbf{m}}{\partial \mathbf{u}_i} - \frac{s}{\|\mathbf{m}\|} \frac{\partial \|\mathbf{m}\|}{\partial \mathbf{u}_i} + \frac{\mathbf{m}}{\|\mathbf{m}\|} \cdot \frac{\partial \mathbf{s}}{\partial \mathbf{u}_i} \quad (261)$$

and

$$\frac{\partial \mathbf{n}}{\partial \mathbf{u}_i} = \frac{1}{\|\mathbf{m}\|} \frac{\partial \mathbf{m}}{\partial \mathbf{u}_i} - \frac{1}{\|\mathbf{m}\|^2} \mathbf{m} \otimes \frac{\partial \|\mathbf{m}\|}{\partial \mathbf{u}_i}. \quad (262)$$

The derivative of \mathbf{s} w.r.t. \mathbf{u}_i can be obtained from the derivative of \mathbf{r} w.r.t. \mathbf{u}_i by keeping ξ and η fixed (notice that the derivative is taken at t_{n+1} , consequently, all derivatives of values at time t_n disappear):

$$\frac{\partial \mathbf{s}}{\partial \mathbf{u}_i} = \delta_{ip} \mathbf{I} - \varphi_i (1 - \delta_{ip}) \mathbf{I}. \quad (263)$$

Physically, the tangential contact equations are as follows (written at the location of slave node p):

- an additive decomposition of the differential tangential displacement in stick \mathbf{t}^e and slip \mathbf{t}^p :

$$\mathbf{t} = \mathbf{t}^e + \mathbf{t}^p. \quad (264)$$

- a stick law ($K_t \equiv \lambda a_p$, where λ is the stick slope and a_p the representative slave area for the slave node at stake) defining the tangential force exerted by the slave side on the master side at the location of slave node p:

$$\mathbf{F}_T = K_t \mathbf{t}^e. \quad (265)$$

- a Coulomb slip limit:

$$\|\mathbf{F}_T\| \leq \mu \|\mathbf{F}_N\| \quad (266)$$

- a slip evolution equation:

$$\dot{\mathbf{t}}^p = \dot{\gamma} \frac{\mathbf{F}_T}{\|\mathbf{F}_T\|} \quad (267)$$

First, a difference form of the additive decomposition of the differential tangential displacement is derived. Starting from

$$\mathbf{t} = \mathbf{t}^e + \mathbf{t}^p, \quad (268)$$

one obtains after taking the time derivative:

$$\dot{\mathbf{t}} = \dot{\mathbf{t}}^e + \dot{\mathbf{t}}^p. \quad (269)$$

Substituting the slip evolution equation leads to:

$$\dot{\gamma} \frac{\mathbf{F}_T}{\|\mathbf{F}_T\|} = \dot{\mathbf{t}} - \dot{\mathbf{t}}^e, \quad (270)$$

and after multiplying with K_t :

$$K_t \dot{\gamma} \frac{\mathbf{F}_T}{\|\mathbf{F}_T\|} = K_t \dot{\mathbf{t}} - K_t \dot{\mathbf{t}}^e \quad (271)$$

Writing this equation at t_{n+1} , using finite differences (backwards Euler), one gets:

$$K_t \Delta \gamma_{n+1} \frac{\mathbf{F}_{T_{n+1}}}{\|\mathbf{F}_{T_{n+1}}\|} = K_t \Delta \mathbf{t}_{n+1} - K_t \mathbf{t}_{n+1}^e + K_t \mathbf{t}_n^e, \quad (272)$$

where $\Delta \gamma_{n+1} \equiv \dot{\gamma}_{n+1} \Delta t$ and $\Delta \mathbf{t}_{n+1} \equiv \mathbf{t}_{n+1} - \mathbf{t}_n$. The parameter K_t is assumed to be independent of time.

Now, the radial return algorithm will be described to solve the governing equations. Assume that the solution at time t_n is known, i.e. \mathbf{t}_n^e and \mathbf{t}_n^p are known. Using the stick law the tangential force \mathbf{F}_{T_n} can be calculated. Now we would like to know these variables at time t_{n+1} , given the total differential tangential displacement \mathbf{t}_{n+1} . At first we construct a trial tangential force $\mathbf{F}_{T_{n+1}}^{trial}$ which is the force which arises at time t_{n+1} assuming that no slip takes place from t_n till t_{n+1} . This assumption is equivalent to $\mathbf{t}_{n+1}^p = \mathbf{t}_n^p$. Therefore, the trial tangential force satisfies (cf. the stick law):

$$\mathbf{F}_{T_{n+1}}^{trial} = K_t (\mathbf{t}_{n+1} - \mathbf{t}_n^p). \quad (273)$$

Now, this can also be written as:

$$\mathbf{F}_{T_{n+1}}^{trial} = K_t (\mathbf{t}_{n+1} - \mathbf{t}_n + \mathbf{t}_n - \mathbf{t}_n^p). \quad (274)$$

or

$$\mathbf{F}_{T_{n+1}}^{trial} = K_t \Delta \mathbf{t}_{n+1} + K_t \mathbf{t}_n^e. \quad (275)$$

Using Equation (272) this is equivalent to:

$$\mathbf{F}_{T_{n+1}}^{trial} = K_t \Delta \gamma_{n+1} \frac{\mathbf{F}_{T_{n+1}}}{\|\mathbf{F}_{T_{n+1}}\|} + K_t \mathbf{t}_{n+1}^e, \quad (276)$$

or

$$\mathbf{F}_{T_{n+1}}^{trial} = (K_t \Delta \gamma_{n+1} \frac{1}{\|\mathbf{F}_{T_{n+1}}\|} + 1) \mathbf{F}_{T_{n+1}}. \quad (277)$$

From the last equation one obtains

$$\mathbf{F}_{T_{n+1}}^{trial} \parallel \mathbf{F}_{T_{n+1}} \quad (278)$$

and, since the terms in brackets in Equation (277) are both positive:

$$\|\mathbf{F}_{T_{n+1}}^{trial}\| = K_t \Delta \gamma_{n+1} + \|\mathbf{F}_{T_{n+1}}\|. \quad (279)$$

The only equation which is left to be satisfied is the Coulomb slip limit. Two possibilities arise:

$$1. \|\mathbf{F}_{T_{n+1}}^{trial}\| \leq \mu \|\mathbf{F}_{N_{n+1}}\|.$$

In that case the Coulomb slip limit is satisfied and we have found the solution:

$$\mathbf{F}_{T_{n+1}} = \mathbf{F}_{T_{n+1}}^{trial} = K_t(\mathbf{t}_{n+1} - \mathbf{t}^p_n) \quad (280)$$

and

$$\frac{\partial \mathbf{F}_{T_{n+1}}}{\partial \mathbf{t}_{n+1}} = K_t \mathbf{I}. \quad (281)$$

No extra slip occurred from t_n to t_{n+1} .

$$2. \|\mathbf{F}_{T_{n+1}}^{trial}\| > \mu \|\mathbf{F}_{N_{n+1}}\|.$$

In that case we project the solution back onto the slip surface and require $\|\mathbf{F}_{T_{n+1}}\| = \mu \|\mathbf{F}_{N_{n+1}}\|$. Using Equation (279) this leads to the following expression for the increase of the consistency parameter γ :

$$\Delta \gamma_{n+1} = \frac{\|\mathbf{F}_{T_{n+1}}^{trial}\| - \mu \|\mathbf{F}_{N_{n+1}}\|}{K_t}, \quad (282)$$

which can be used to update \mathbf{t}^p (by using the slip evolution equation):

$$\Delta \mathbf{t}^p = \Delta \gamma_{n+1} \frac{\mathbf{F}_{T_{n+1}}}{\|\mathbf{F}_{T_{n+1}}\|} = \Delta \gamma_{n+1} \frac{\mathbf{F}_{T_{n+1}}^{trial}}{\|\mathbf{F}_{T_{n+1}}^{trial}\|} \quad (283)$$

The tangential force can be written as:

$$\mathbf{F}_{T_{n+1}} = \|\mathbf{F}_{T_{n+1}}\| \frac{\mathbf{F}_{T_{n+1}}}{\|\mathbf{F}_{T_{n+1}}\|} = \mu \|\mathbf{F}_{N_{n+1}}\| \frac{\mathbf{F}_{T_{n+1}}^{trial}}{\|\mathbf{F}_{T_{n+1}}^{trial}\|}. \quad (284)$$

Now since

$$\frac{\partial \|\mathbf{a}\|}{\partial \mathbf{b}} = \frac{\mathbf{a}}{\|\mathbf{a}\|} \cdot \frac{\partial \mathbf{a}}{\partial \mathbf{b}} \quad (285)$$

and

$$\frac{\partial}{\partial \mathbf{b}} \left(\frac{\mathbf{a}}{\|\mathbf{a}\|} \right) = \frac{1}{\|\mathbf{a}\|} \left[\mathbf{I} - \left(\frac{\mathbf{a}}{\|\mathbf{a}\|} \right) \otimes \left(\frac{\mathbf{a}}{\|\mathbf{a}\|} \right) \right] \cdot \frac{\partial \mathbf{a}}{\partial \mathbf{b}}, \quad (286)$$

where \mathbf{a} and \mathbf{b} are vectors, one obtains for the derivative of the tangential force:

$$\begin{aligned} \frac{\partial \mathbf{F}_{T_{n+1}}}{\partial t_{n+1}} &= \mu \boldsymbol{\xi}_{n+1} \otimes \left[\frac{\mathbf{F}_{N_{n+1}}}{\|\mathbf{F}_{N_{n+1}}\|} \cdot \frac{\partial \mathbf{F}_{N_{n+1}}}{\partial t_{n+1}} \right] \\ &+ \mu \frac{\|\mathbf{F}_{N_{n+1}}\|}{\|\mathbf{F}_{T_{n+1}}^{trial}\|} [\mathbf{I} - \boldsymbol{\xi}_{n+1} \otimes \boldsymbol{\xi}_{n+1}] \cdot \frac{\partial \mathbf{F}_{T_{n+1}}^{trial}}{\partial t_{n+1}}, \end{aligned} \quad (287)$$

where

$$\boldsymbol{\xi}_{n+1} \equiv \frac{\mathbf{F}_{T_{n+1}}^{trial}}{\|\mathbf{F}_{T_{n+1}}^{trial}\|}. \quad (288)$$

One finally arrives at (using Equation (281))

$$\begin{aligned} \frac{\partial \mathbf{F}_{T_{n+1}}}{\partial \mathbf{u}_{i_{n+1}}} &= \mu \boldsymbol{\xi}_{n+1} \otimes \left[-\mathbf{n} \cdot \frac{\partial \mathbf{F}_{N_{n+1}}}{\partial \mathbf{u}_{i_{n+1}}} \right] \\ &+ \mu \frac{\|\mathbf{F}_{N_{n+1}}\|}{\|\mathbf{F}_{T_{n+1}}^{trial}\|} [\mathbf{I} - \boldsymbol{\xi}_{n+1} \otimes \boldsymbol{\xi}_{n+1}] \cdot K_t \frac{\partial t_{n+1}}{\partial \mathbf{u}_{i_{n+1}}}. \end{aligned} \quad (289)$$

All quantities on the right hand side are known now (cf. Equation (236) and Equation (260)).

In CalculiX, for node-to-face contact, Equation (251) is reformulated and simplified. It is reformulated in the sense that \mathbf{q}_{n+1} is assumed to be the projection of \mathbf{p}_{n+1} and \mathbf{q}_n is written as (cf. Figure 132, part b))

$$\mathbf{q}_n = \sum_j \varphi_j(\xi_{n+1}^m, \eta_{n+1}^m) \mathbf{q}_{j_n}. \quad (290)$$

Part a) and part b) of the figure are really equivalent, they just represent the same facts from a different point of view. In part a) the projection on the master surface is performed at time t_n , and the differential displacement is calculated at time t_{n+1} , in part b) the projection is done at time t_{n+1} and the differential displacement is calculated at time t_n . Now, the actual position can be written as the sum of the undeformed position and the deformation, i.e. $\mathbf{p} = (\mathbf{X} + \mathbf{v})^s$ and $\mathbf{q} = (\mathbf{X} + \mathbf{v})^m$ leading to:

$$\mathbf{s} = (\mathbf{X} + \mathbf{v})_{n+1}^s - (\mathbf{X} + \mathbf{v})_{n+1}^m(\xi_{n+1}^m, \eta_{n+1}^m) - (\mathbf{X} + \mathbf{v})_n^s + (\mathbf{X} + \mathbf{v})_n^m(\xi_{n+1}^m, \eta_{n+1}^m). \quad (291)$$

Since the undeformed position is no function of time it drops out:

$$\mathbf{s} = \mathbf{v}_{n+1}^s - \mathbf{v}_{n+1}^m(\xi_{n+1}^m, \eta_{n+1}^m) - \mathbf{v}_n^s + \mathbf{v}_n^m(\xi_{n+1}^m, \eta_{n+1}^m) \quad (292)$$

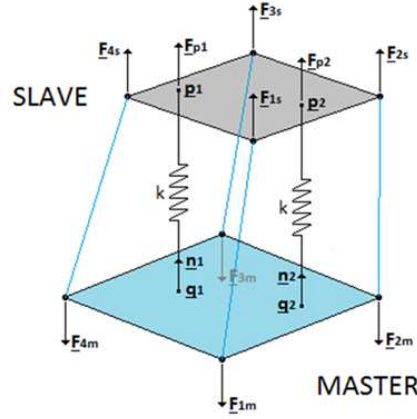

Figure 133: Creation of a face-to-face penalty contact element

or:

$$\mathbf{s} = \mathbf{v}_{n+1}^s - \mathbf{v}_{n+1}^m(\xi_{n+1}^m, \eta_{n+1}^m) - \mathbf{v}_n^s + \mathbf{v}_n^m(\xi_n^m, \eta_n^m) \quad (293)$$

$$+ \mathbf{v}_n^m(\xi_{n+1}^m, \eta_{n+1}^m) - \mathbf{v}_n^m(\xi_n^m, \eta_n^m) \quad (294)$$

Now, the last two terms are dropped, i.e. it is assumed that the differential deformation at time t_n between positions (ξ_n^m, η_n^m) and $(\xi_{n+1}^m, \eta_{n+1}^m)$ is negligible compared to the differential motion from t_n to t_{n+1} . Then the expression for \mathbf{s} simplifies to:

$$\mathbf{s} = \mathbf{v}_{n+1}^s - \mathbf{v}_{n+1}^m(\xi_{n+1}^m, \eta_{n+1}^m) - \mathbf{v}_n^s + \mathbf{v}_n^m(\xi_n^m, \eta_n^m), \quad (295)$$

and the only quantity to be stored is the difference in deformation between \mathbf{p} and \mathbf{q} at the actual time and at the time of the beginning of the increment.

6.7.6 Face-to-Face Penalty Contact

General considerations In the face-to-face penalty contact formulation the spring element which was described in the previous section is now applied between an integration point of a slave face and a master face (spring in Figure 133). The contact force at the integration point is subsequently transferred to the nodes of the slave face. This results in contact spring elements connecting a slave face with a master face (full lines in Figure 133). The integration points in the slave faces are not the ordinary Gauss points. Instead, the master and slave mesh are put on top of each other, the common areas, which are polygons

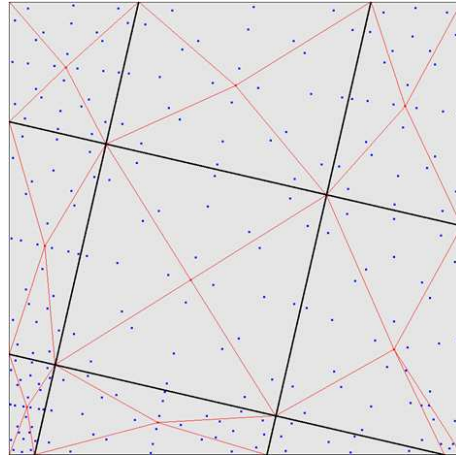

Figure 134: Integration points resulting from the cutting of one master face (big square) with several slave faces (small, slanted squares)

(sides of quadratic elements are approximated by piecewise linear lines), are identified and triangulated. For each triangle a 7-node scheme is used (Figure 134). This can result to up to 100 or more integration points within one slave face. It usually leads to a very smooth pressure distribution. Furthermore, it is now irrelevant which side is defined as master and which as slave. In the present formulation the following approximations are used:

- the linear pressure-overclosure relationship is truly bilinear, i.e. zero for positive clearance and linear for penetration (and not quasi bilinear as for node-to-face penalty). The value of c_0 is zero.
- the matching between the slave faces and master faces, the calculation of the resulting integration points and the local normals on the master surface is done once at the start of each increment. This information is not changed while iterating within an increment. The same applies to the calculation of the area for which the slave integration point is representative.
- whether a contact element is active or not is determined in each iteration anew. A contact element is active if the penetration is positive.

Due to the freezing of the match between the slave and master surface within each increment, large deformations of the structure may require small increments.

The contact definition in the input deck is similar to the node-to-face penalty contact except for:

- The contact surfaces (both slave and master) must be face-based.

- On the *CONTACT PAIR card the parameter TYPE=SURFACE TO SURFACE must be specified.
- The SMALL SLIDING parameter on the *CONTACT PAIR card is not allowed.
- The *SURFACE BEHAVIOR card for a linear pressure-overclosure relationship needs only one parameter: the spring constant.
- The *FRICTION card is needed to specify the friction coefficient and the stick slope.

In addition, a new pressure-overclosure relationship is introduced with the name TIED. It can be used to tie surfaces and usually leads to a significantly smoother stress distribution than the MPC's generated by the *TIE option. For the TIED pressure-overclosure relation only two parameters are used: the spring stiffness K (> 0 , required), and the stick slope λ (> 0 , optional). The friction coefficient is irrelevant.

Weak formulation The contribution of the face-to-face penalty contact to the weak formulation corresponds to the first term on the right hand side of Equation (2.6) in [23], written for both the slave and master side. This amounts to (in the material frame of reference):

$$\int_{A_s^0} \delta(\mathbf{U}^S - \mathbf{U}^M) \cdot \mathbf{T}_{(N)} dA, \quad (296)$$

or, in the spatial frame of reference:

$$\int_{A_s} \delta(\mathbf{u}^s - \mathbf{u}^m) \cdot \mathbf{t}_{(n)} da. \quad (297)$$

Making a Taylor expansion for $\mathbf{t}_{(n)}$, which is a function of $\mathbf{u}^s - \mathbf{u}^m$ and keeping the linear term only (the constant term vanishes since zero differential displacements leads to zero traction) one obtains:

$$\int_{A_s} \delta(\mathbf{u}^s - \mathbf{u}^m) \cdot \frac{\partial \mathbf{t}_{(n)}}{\partial \mathbf{u}^s} \cdot (\mathbf{u}^s - \mathbf{u}^m) da. \quad (298)$$

Notice that the integral is over the slave faces. The corresponding positions on the master side are obtained by local orthogonal projection. The displacements within a face on the slave side can be written as a linear combination of the displacements of the nodes belonging to the face (n_s is the number of nodes belonging to the slave face):

$$\mathbf{u}^s = \sum_i^{n_s} \varphi_i \mathbf{u}_i^s, \quad (299)$$

and similarly for the displacements on the master side (n_m^l is the number of nodes belonging to the master face m^l):

$$\mathbf{u}^{m^l} = \sum_j^{n_m^l} \psi_j^l \mathbf{u}_j^{m^l}. \quad (300)$$

Substituting the above expressions in Equation (298) one obtains:

$$\begin{aligned} & \sum_s \sum_{i=1}^{n_s} \sum_{j=1}^{n_s} \delta \mathbf{u}_i^s \cdot \left[\int_{A_s} \varphi_i \frac{\partial \mathbf{t}(\mathbf{n})}{\partial \mathbf{u}^s} \varphi_j da \right] \cdot \mathbf{u}_j^s \\ & - \sum_s \sum_l \sum_{i=1}^{n_s} \sum_{j=1}^{n_m^l} \delta \mathbf{u}_i^s \cdot \left[\int_{A_s^l} \varphi_i \frac{\partial \mathbf{t}(\mathbf{n})}{\partial \mathbf{u}^s} \psi_j^l da \right] \cdot \mathbf{u}_j^{m^l} \\ & - \sum_s \sum_l \sum_{i=1}^{n_m^l} \sum_{j=1}^{n_s} \delta \mathbf{u}_i^{m^l} \cdot \left[\int_{A_s^l} \psi_i^l \frac{\partial \mathbf{t}(\mathbf{n})}{\partial \mathbf{u}^s} \varphi_j da \right] \cdot \mathbf{u}_j^s \\ & + \sum_s \sum_l \sum_{i=1}^{n_m^l} \sum_{j=1}^{n_m^l} \delta \mathbf{u}_i^{m^l} \cdot \left[\int_{A_s^l} \psi_i^l \frac{\partial \mathbf{t}(\mathbf{n})}{\partial \mathbf{u}^s} \psi_j^l da \right] \cdot \mathbf{u}_j^{m^l}. \end{aligned} \quad (301)$$

where “ A_s^l ” is the part of the slave face s , the orthogonal projection of which is contained in the master face m^l . This leads to the following stiffness contributions (notice the change in sign, since the weak term has to be transferred to the left hand side of Equation (2.6) in [23]):

$$[K]_{e(iK)(jM)} = - \int_{A_s} \varphi_i \frac{\partial \mathbf{t}(\mathbf{n})^K}{\partial \mathbf{u}^s_M} \varphi_j da, \quad i \in S, j \in S \quad (302)$$

$$[K]_{e(iK)(jM)} = \sum_l \int_{A_s^l} \varphi_i \frac{\partial \mathbf{t}(\mathbf{n})^K}{\partial \mathbf{u}^s_M} \psi_j^l da, \quad i \in S, j \in M^l \quad (303)$$

$$[K]_{e(iK)(jM)} = \sum_l \int_{A_s^l} \psi_i^l \frac{\partial \mathbf{t}(\mathbf{n})^K}{\partial \mathbf{u}^s_M} \varphi_j da, \quad i \in M^l, j \in S \quad (304)$$

$$[K]_{e(iK)(jM)} = - \sum_l \int_{A_s^l} \psi_i^l \frac{\partial \mathbf{t}(\mathbf{n})^K}{\partial \mathbf{u}^s_M} \psi_j^l da, \quad i \in M^l, j \in M^l \quad (305)$$

S is the slave face “ s ” at stake, M^l is the master face to which the orthogonal projection of the infinitesimal slave area da belongs. The integrals in the above expression are evaluated by numerical integration. One could, for instance, use the classical Gauss points in the slave faces. This, however, will not give optimal results, since the master and slave faces do not match and the function to integrate exhibits discontinuities in the derivatives. Much better results are

obtained by using the integration scheme presented in the previous section and illustrated in Figure 134. In this way, the above integrals are replaced by:

$$-\int_{A_s} \varphi_i \frac{\partial \mathbf{t}(\mathbf{n})^K}{\partial \mathbf{u}^s_M} \varphi_j da = -\sum_k \varphi_i(\xi_{s_k}, \eta_{s_k}) \varphi_j(\xi_{s_k}, \eta_{s_k}) \left. \frac{\partial \mathbf{t}(\mathbf{n})^K}{\partial \mathbf{u}^s_M} \right|_{\xi_{s_k}, \eta_{s_k}} \|\mathbf{J}\|_k w_k, \quad (306)$$

$$\int_{A_s^l} \varphi_i \frac{\partial \mathbf{t}(\mathbf{n})^K}{\partial \mathbf{u}^s_M} \psi_j^l da = \sum_k \varphi_i(\xi_{s_k}, \eta_{s_k}) \psi_j^l(\xi_{m_k}, \eta_{m_k}) \left. \frac{\partial \mathbf{t}(\mathbf{n})^K}{\partial \mathbf{u}^s_M} \right|_{\xi_{s_k}, \eta_{s_k}} \|\mathbf{J}\|_k w_k, \quad (307)$$

$$\int_{A_s^l} \psi_i^l \frac{\partial \mathbf{t}(\mathbf{n})^K}{\partial \mathbf{u}^s_M} \varphi_j da = \sum_k \psi_i^l(\xi_{m_k}, \eta_{m_k}) \varphi_j(\xi_{s_k}, \eta_{s_k}) \left. \frac{\partial \mathbf{t}(\mathbf{n})^K}{\partial \mathbf{u}^s_M} \right|_{\xi_{s_k}, \eta_{s_k}} \|\mathbf{J}\|_k w_k, \quad (308)$$

$$-\int_{A_s^l} \psi_i^l \frac{\partial \mathbf{t}(\mathbf{n})^K}{\partial \mathbf{u}^s_M} \psi_j^l da = -\sum_k \psi_i^l(\xi_{m_k}, \eta_{m_k}) \psi_j^l(\xi_{m_k}, \eta_{m_k}) \left. \frac{\partial \mathbf{t}(\mathbf{n})^K}{\partial \mathbf{u}^s_M} \right|_{\xi_{s_k}, \eta_{s_k}} \|\mathbf{J}\|_k w_k, \quad (309)$$

where k is the number of the integration point; (ξ_{s_k}, η_{s_k}) are the local coordinates of the slave integration point; (ξ_{m_k}, η_{m_k}) are the local coordinates of the orthogonal projection of the slave integration point onto the master surface w.r.t. the master face to which the projection belongs; $\|\mathbf{J}\|_k$ is the norm of the local Jacobian vector at the integration point on the slave face and w_k is the weight. As noted before the projection of integration points within the same slave face may belong to different master faces. Each slave integration point k leads to a contact element connecting a slave face with a master face and represented by a stiffness matrix of size $3(n_s + n_m) \times 3(n_s + n_m)$ made up of contributions described by the above equations for just one value of integration point k .

From this one observes that it is sufficient to determine the 3x3 stiffness matrix

$$\left. \frac{\partial \mathbf{t}(\mathbf{n})^K}{\partial \mathbf{u}^s_M} \right|_{\xi_{s_k}, \eta_{s_k}} \quad (310)$$

at the slave integration points in order to obtain the stiffness matrix of the complete contact element. It represents the derivative of the traction in an integration point of the slave surface with respect to the displacement vector at the same location.

Normal contact stiffness The traction exerted by the master face on the slave face at a slave integration point \mathbf{p} can be written analogous to Equation (232):

$$\mathbf{t}_{(\mathbf{n})} = f(r)\mathbf{n}. \quad (311)$$

For simplicity, in the face-to-face penalty contact formulation it is assumed that within an increment the location (ξ_{m_k}, η_{m_k}) of the projection of the slave integration points on the master face and the local Jacobian on the master face do not change. Consequently (cf. the section 6.7.5):

$$\frac{\partial \mathbf{m}}{\partial \mathbf{u}_{\mathbf{p}}} = \frac{\partial \xi}{\partial \mathbf{u}_{\mathbf{p}}} = \frac{\partial \eta}{\partial \mathbf{u}_{\mathbf{p}}} = \mathbf{0}. \quad (312)$$

and

$$\frac{\partial \mathbf{r}}{\partial \mathbf{u}_{\mathbf{p}}} = \mathbf{I}, \quad (313)$$

which leads to

$$\frac{\partial \mathbf{t}_{(\mathbf{n})}}{\partial \mathbf{u}_{\mathbf{p}}} = \frac{\partial f}{\partial r} \mathbf{n} \otimes \mathbf{n}. \quad (314)$$

This is the normal contact contribution to Equation (310).

Tangent contact stiffness Due to the assumption that the projection of the slave integration point on the master surface does not change during an increment, and that the local normal on the master surface does not change either, the equations derived in the section on node-to-face contact simplify to:

$$\frac{\partial \mathbf{t}}{\partial \mathbf{u}_{\mathbf{p}}} = (\mathbf{I} - \mathbf{n} \otimes \mathbf{n}) \cdot \frac{\partial \mathbf{s}}{\partial \mathbf{u}_{\mathbf{p}}}, \quad (315)$$

where

$$\frac{\partial \mathbf{s}}{\partial \mathbf{u}_{\mathbf{p}}} = \mathbf{I}. \quad (316)$$

Equation (289) now reduces to

$$\begin{aligned} \frac{\partial \mathbf{t}_{(\tau)_{n+1}}}{\partial \mathbf{u}_{\mathbf{p}_{n+1}}} &= \mu \boldsymbol{\xi}_{n+1} \otimes \left[-\mathbf{n} \cdot \frac{\partial \mathbf{t}_{(\mathbf{n})_{n+1}}}{\partial \mathbf{u}_{\mathbf{p}_{n+1}}} \right] \\ &+ \mu \frac{\|\mathbf{t}_{(\mathbf{n})_{n+1}}\|}{\|\mathbf{t}_{(\tau)_{n+1}}^{trial}\|} [\mathbf{I} - \boldsymbol{\xi}_{n+1} \otimes \boldsymbol{\xi}_{n+1}] \cdot K_t \frac{\partial \mathbf{t}_{n+1}}{\partial \mathbf{u}_{\mathbf{p}_{n+1}}}. \end{aligned} \quad (317)$$

Be careful to distinguish $\mathbf{t}_{(\mathbf{n})_{n+1}}$ and $\mathbf{t}_{(\tau)_{n+1}}$, which are tractions, from \mathbf{t}_{n+1} , which is a tangential differential displacement.

6.7.7 Face-to-Face Mortar Contact

This is a face-to-face contact formulation using extra Lagrange multipliers to model the contact stresses. It can be used for hard contact (infinite stress at the slightest penetration) or soft contact (gradually increasing stress the larger the penetration as in materials with a definite surface roughness). Due to the Lagrange multipliers the stress-penetration relationship satisfied in a weak sense. This is different from the face-to-face penalty method, in which the knowledge of the penetration uniquely leads to the contact stresses. Due to this property the convergence of the mortar method is somewhat better than in the face-to-face penalty method, i.e. less iterations are needed. However, the cost of one iteration is higher. For details the reader is referred to [91]-[94].

The implementation in CalculiX uses dual basis functions for the Lagrange multiplier. Dual basis functions are in a weak sense orthogonal to the standard basis functions used for the displacements. Due to the use of dual basis functions the Lagrange multiplier degrees of freedom can be easily eliminated from the resulting equation system and therefore the number of unknowns in the system is in each iteration not larger than without contact. Because the negative parts of the standard basis functions for quadratic elements can cause problems, several options to circumvent these problems have been implemented. Right now, the user can choose between `TYPE=MORTAR`, `TYPE=LINMORTAR` and `TYPE=PGLINMORTAR` on the `*CONTACT PAIR` card. For `TYPE=MORTAR` the standard dual basis functions are used for the Lagrange multiplier. For `TYPE=LINMORTAR` linear dual basis functions are used, i.e. the Lagrange multiplier at the midnodes (if any) is not taken into account. For linear elements `MORTAR` and `LINMORTAR` coincide. In case of `TYPE=PGLINMORTAR` the variation of the Lagrange multiplier is done using linear standard basis functions (PG stands for Petrov-Galerkin). The following rules apply when using Mortar contact:

- The mortar method is only available for the `*STATIC` procedure. Consequently, it can not be used for dynamic calculations, heat transfer calculations or (un)coupled temperature-displacement calculations, to name a few.
- It is advised to use the mortar method for contact between genuine 3-dimensional elements only. Usage for contact in between 1-d or 2-d elements will cause problems. In general, the mortar method is not well suited if the contact areas are too much constrained by extra multiple point constraints.
- The mortar method cannot be combined with the penalty method in one input file. Also a single mortar method (`MORTAR` or `LINMORTAR` or `PGLINMORTAR`) has to be chosen for all contact pairs in one input file.
- Using the `*CYCLIC SYMMETRY MODEL` option, one has to make sure that a one-to-one connection is made if the slave surface touches the cyclic

symmetry boundary. If non-matching meshes are used, one has to make sure that the contact surfaces touching the cyclic symmetry boundary are removed from the slave surface definition.

- One must not apply extra multiple point constraints to edge nodes on the slave surface. Please apply extra mounting MPC's only to corner nodes on the slave surface.
- Define different contact pairs for different contact zones (contact search algorithm is faster)
- Define contact surfaces only as large as needed (contact search algorithm is faster)
- One must not use the same contact surface in more than one contact definition
- Make sure that the contact surfaces do not touch pretension sections
- Make sure that there is not gap between the bodies for force driven quasi-static calculations (may lead to huge accelerations since no mass is defined and consequently no contact is found)
- Make sure that you choose a small first increment in the step if you expect large relative displacements in tangential direction. A minimum of four increments is recommended. Recall that the direction of the normal and tangential directions and the surface segmentation is only performed once per increment.
- Shrink is always active in CalculiX, i.e. overlaps are resolved increment-wise across the step.
- Sometimes the adaptive time stepping using mortar contact is too sensitive. Try *STEP,DIRECT in that case.

6.7.8 Massless Node-to-Face Contact

The massless node-to-face contact formulation has been introduced in CalculiX in order to model perfectly hard contact within explicit dynamic calculations. The implementation closely follows [66].

For the sake of simplicity, frictionless contact is taken as example. Let g denote the gap, λ is the contact force.

For a zero contact force the gap can be any positive real number including zero (\mathbb{R}_0^+), for a strictly positive force the gap is zero and a negative contact force is not plausible (i.e. no adhesion is assumed). These dependencies can be represented in the form of $g(\lambda)$ as in Figure 135. For dynamic calculations with friction the gap velocity $\gamma = \dot{g}$ is used in the contact laws. In principle, the gap velocity can be positive or negative. Indeed, if an object is approaching an obstacle the gap decreases and the velocity is negative. After collision the gap

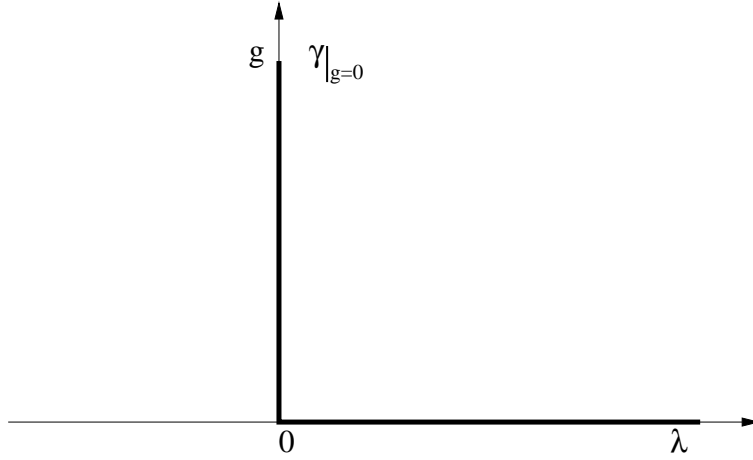

Figure 135: Normal hard contact

is increasing and the velocity is positive. However, at collision (i.e. $g = 0$) $\gamma \geq 0$ is satisfied (the gap remains zero for static equilibrium or is increasing after a collision) and now Figure 135 also applies for $\gamma(\lambda)$. In order for the velocity to be strictly positive, the force has to be zero.

Now, a couple of mathematical concepts are introduced. For further details the reader is referred to [49] and [99].

- A function is set-valued if it can have more than one value for a given argument. For instance, the gap velocity function satisfies

$$\lambda = 0 \Rightarrow 0 \leq \gamma \leq \infty \quad (318)$$

$$\lambda > 0 \Rightarrow \gamma = 0 \quad (319)$$

The admissible set on which γ is defined is \mathbb{R}_0^+ .

- A set \mathcal{C} is convex if any linear combination of elements \mathbf{x}_1 and \mathbf{x}_2 of the form $(1 - \alpha)\mathbf{x}_1 + \alpha\mathbf{x}_2, 0 \leq \alpha \leq 1$ also belongs to \mathcal{C} . For instance, the interior of a circle in two-dimensional space is convex. This also applies to the interior supplemented by the boundary of the circle. The interior of a ring is not convex. \mathbb{R}_0^+ is convex.
- The indicator function ψ for a set \mathcal{C} is defined by:

$$\psi_{\mathcal{C}}(\mathbf{x}) = \begin{cases} 0 & \text{if } \mathbf{x} \in \mathcal{C} \\ \infty & \text{if } \mathbf{x} \notin \mathcal{C} \end{cases} \quad (320)$$

So the indicator function is zero for all elements included in the set and infinity else. The indicator function for \mathbb{R}_0^+ is shown in Figure 136 (bold line)

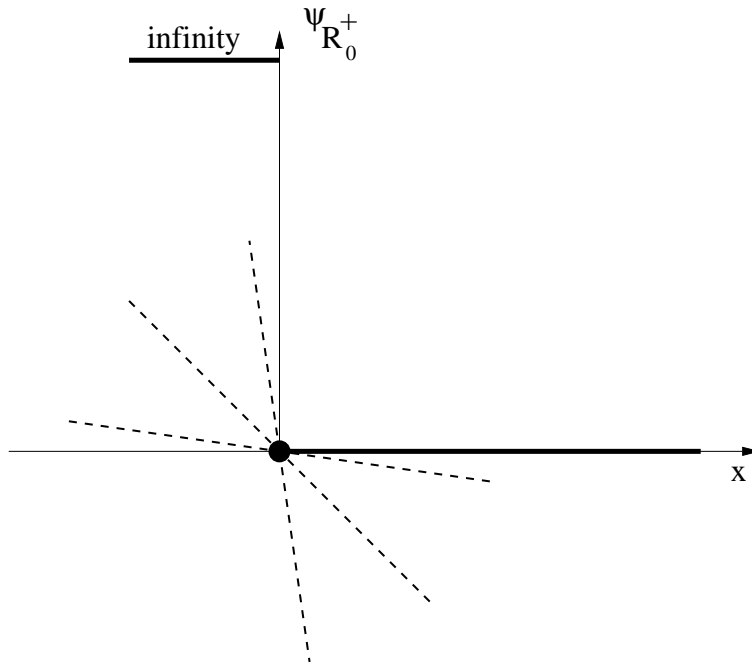
Figure 136: Indicator function for \mathbb{R}_0^+

- A function $\mathcal{C} \rightarrow \mathbb{R}$ is convex when $\{(\mathbf{x}, y) | y \geq f(\mathbf{x}); \mathbf{x} \in \mathcal{C}\}$ is a convex set. For instance, for a function on a set in the two-dimensional domain \mathbb{R}^2 this means that the three-dimensional volume above the function values has to be a convex set. Since the indicator function $\psi_{\mathcal{C}}$ is zero everywhere in the set \mathcal{C} it is clear that the indicator function of a convex set is convex.
- Now, the concept of subdifferential can be explained, which is a generalization of the differential for functions with kinks. The subdifferential $\partial f(\mathbf{x})$ of a convex function $f(\mathbf{x})$ is defined by:

$$\partial f(\mathbf{x}) = \{\mathbf{y} | f(\mathbf{x}^*) \geq f(\mathbf{x}) + \mathbf{y} \cdot (\mathbf{x}^* - \mathbf{x}); \forall \mathbf{x}^* \in \mathcal{C}\}, \quad (321)$$

for $f(\mathbf{x}) < +\infty$, where “ \cdot ” is the inner product. This means that all function values have to exceed a “tangent” straight line with the subdifferential as slope. As shown in Figure 137 the subdifferential at point b , where the function is continuous differentiable, coincides with the derivative. In point a , where the function is continuous but not differentiable, the subdifferential consists of all tangent lines in between the left and right derivative at that point. Thus, the subdifferential in a is multivalued and a set-valued function. The same applies to the origin in Figure 136 (dashed lines). Indeed, by comparing Figures 135 and 136 one observes that the subdifferential of the indicator function of \mathbb{R}_0^+ coincides with $-\gamma$:

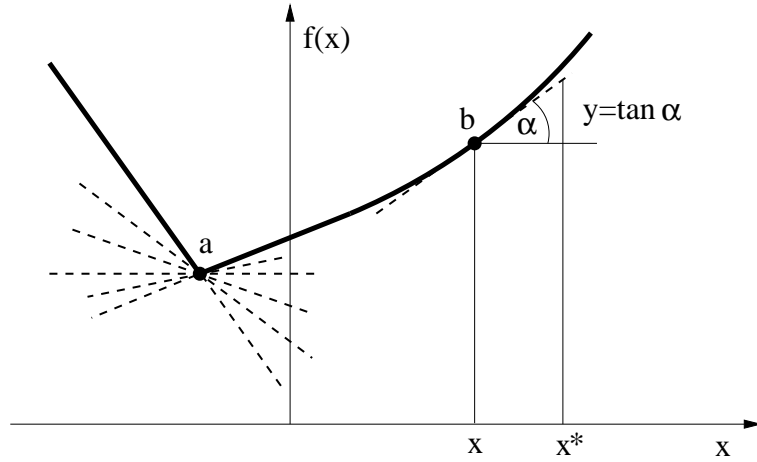

Figure 137: Subdifferential at several positions

$$\partial\psi_{\mathbb{R}_0^+} = -\gamma. \quad (322)$$

From analysis it is well known that for a continuous differentiable function a minimum requires that the derivative is zero. From Figure 137 it is obvious that for a minimum of a C_0 -continuous function

$$0 \in \partial f(\mathbf{x}) \quad (323)$$

has to be satisfied. For the indicator function ψ the definition of subdifferential reduces to:

$$\partial\psi_{\mathcal{C}}(\mathbf{x}) = \{\mathbf{y} | 0 \geq \mathbf{y} \cdot (\mathbf{x}^* - \mathbf{x}); \forall \mathbf{x}^* \in \mathcal{C}\}, \quad (324)$$

since the indicator function is zero in \mathcal{C} .

- Now, the normal cone of \mathcal{C} in \mathbf{x} is defined by:

$$\mathcal{N}_{\mathcal{C}}(\mathbf{x}) = \{\mathbf{y} | \mathbf{y} \cdot (\mathbf{x}^* - \mathbf{x}) \leq 0; \forall \mathbf{x}^* \in \mathcal{C}; \mathbf{x} \in \mathcal{C}\}, \quad (325)$$

i.e. it is the set of all vectors which make an angle $\geq 90^\circ$ with all vectors connecting $\mathbf{x} \in \mathcal{C}$ with any other point $\mathbf{x}^* \in \mathcal{C}$.

Looking at Figure 138 the normal cone in a is $\{\mathbf{0}\}$, in b it is (the vectors on) a straight line locally orthogonal to \mathcal{C} and in c it is (the vectors within) a cone bordered by the dashed lines. By comparing Equations (324) and (325) it is clear that:

$$\partial\psi_{\mathcal{C}}(\mathbf{x}) = \mathcal{N}_{\mathcal{C}}(\mathbf{x}). \quad (326)$$

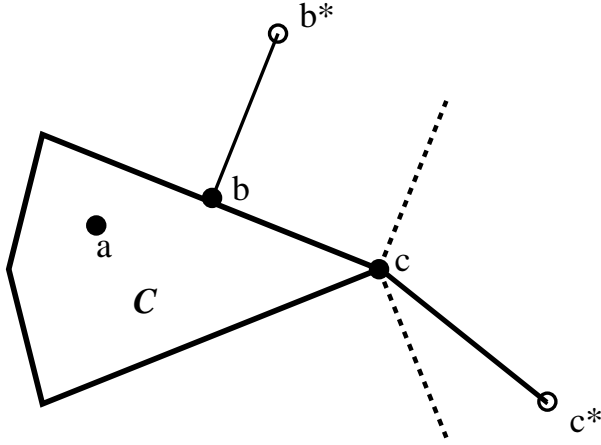

Figure 138: Normal cone at several positions

This establishes a relationship between the subdifferential and the normal cone concept.

- Next, the concept of proximal point is introduced. The proximal point of z w.r.t. \mathcal{C} is defined by:

$$\text{prox}_{\mathcal{C}}(z) = \operatorname{argmin}_{\{x^* \in \mathcal{C}\}} \|z - x^*\|, \quad (327)$$

i.e. it is the point within \mathcal{C} which is closest to z . For instance, looking at Figure 138 the proximal point of b^* is b and the proximal point of c^* is c . Now, the concept of proximal point can be linked to the normal cone and subdifferential definitions. Indeed:

$$x = \text{prox}_{\mathcal{C}}(z) \quad (328)$$

$$\Leftrightarrow x = \operatorname{argmin}_{\{x^* \in \mathcal{C}\}} \|x^* - z\| \quad (329)$$

$$\Leftrightarrow x = \operatorname{argmin}_{\{x^* \in \mathcal{C}\}} \left[\frac{1}{2} \|x^* - z\|^2 \right] \quad (330)$$

$$\Leftrightarrow x = \operatorname{argmin} \left[\frac{1}{2} \|x^* - z\|^2 + \psi_{\mathcal{C}}(x^*) \right] \quad (331)$$

Notice that by adding the indicator function the constraint $\{x^* \in \mathcal{C}\}$ was removed and a convex constrained minimization problem is turned into a convex unconstrained minimization problem. A minimum is obtained if zero belongs to the subdifferential, i.e.:

$$\mathbf{0} \in \partial \left[\frac{1}{2} \|\mathbf{x} - \mathbf{z}\|^2 + \psi_{\mathcal{C}}(\mathbf{x}) \right] \quad (332)$$

$$\Leftrightarrow \mathbf{0} \in \mathbf{x} - \mathbf{z} + \partial\psi_{\mathcal{C}}(\mathbf{x}) \quad (333)$$

$$\Leftrightarrow \mathbf{z} - \mathbf{x} \in \partial\psi_{\mathcal{C}}(\mathbf{x}) \quad (334)$$

$$\Leftrightarrow \mathbf{z} - \mathbf{x} \in \mathcal{N}_{\mathcal{C}}(\mathbf{x}) \quad (335)$$

This means that one can write:

$$\boldsymbol{\xi} \in \mathcal{N}_{\mathcal{C}}(\mathbf{x}) \Leftrightarrow \mathbf{x} = \text{prox}_{\mathcal{C}}(\boldsymbol{\xi} + \mathbf{x}). \quad (336)$$

This finishes the mathematical excursion.

Applying this to the relationship between the gap velocity γ and the normal contact force λ one can write:

$$-\gamma \in \partial\psi_{\mathbb{R}_0^+}(\lambda) \Leftrightarrow -\gamma \in \mathcal{N}_{\mathbb{R}_0^+}(\lambda) \Leftrightarrow \lambda = \text{prox}_{\mathbb{R}_0^+}(-\gamma + \lambda), \quad (337)$$

which turns a set relationship into a nonlinear equation, which is easier to solve. Notice that solving for a proximal point usually boils down to a projection on the admissible set.

If friction is present the feasible domain consists of the positive real numbers (including zero) for the normal contact, and a disk with a radius equal to the friction coefficient times the normal force:

$$-\gamma_n \in \mathcal{N}_{\mathbb{R}_0^+}(\lambda_n) \quad (338)$$

$$-\boldsymbol{\gamma}_t \in \mathcal{N}_{S_p}(\boldsymbol{\lambda}_t) \quad (339)$$

$$S_p = \{\boldsymbol{\lambda}_t \mid \|\boldsymbol{\lambda}_t\| \leq \mu\lambda_n\} \quad (340)$$

Notice that the feasible domain is split into a normal and a tangential domain. Therefore, also the projection is split: in normal direction the projection is on \mathbb{R}_0^+ , in tangential direction on S_p .

In the following a node-to-face contact definition is assumed (cf. Section 6.7.5). For the gap definition one can start from MPC's connecting a slave node with the opposite master face, e.g. for node a in Figure 139:

$$\mathbf{u}_a = 0.5\mathbf{u}_b + 0.5\mathbf{u}_c, \quad (341)$$

where \mathbf{u} represents the displacement field. In the more general case the coefficients have to be determined from the shape functions of the master face. The gap vector can now be written as (assuming the gap is at the beginning of the calculation zero):

$$\mathbf{g} = \mathbf{u}_a - 0.5\mathbf{u}_b - 0.5\mathbf{u}_c. \quad (342)$$

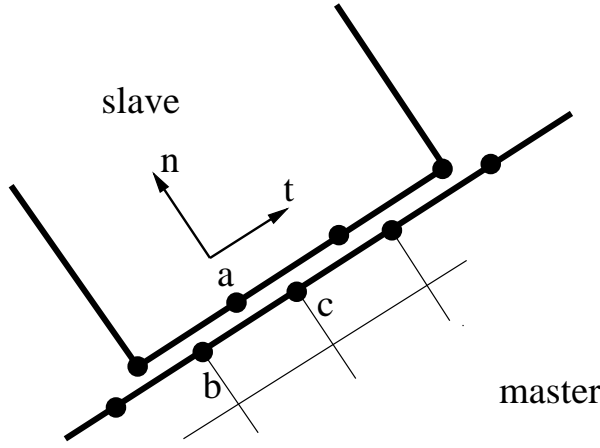

Figure 139: Contact area

This vector can be transformed in a $\{n, t\}$ coordinate system leading to a normal component and two tangential components for the gap. This can be done for all slave nodes leading to the relationship:

$$\{g\} = [W_b]^T \{U_b\} + \{g_0(t)\}. \quad (343)$$

$\{g\}$ contains the gap in local coordinates. Its length is 3 times the number of slave nodes in the model (for three-dimensional applications). $\{U_b\}$ is a vector containing the displacements of all contact boundary nodes, i.e. slave nodes and master nodes, in the global orthogonal coordinate system. $\{g_0(t)\}$ represents the initial gap. Assuming small sliding and small deformations, the matrix $[W_b]$ can be assumed constant. Taking the derivative w.r.t. time of the above equation yields:

$$\{\dot{g}\} = [W_b]^T \{V_b\} + \{\dot{g}_0(t)\}, \quad (344)$$

where $\{V_b\}$ denotes the velocity of all contact boundary nodes. Now, the equations of motion are written thereby neglecting the mass and damping terms for the contact boundary nodes (the index i denotes the internal nodes):

$$\begin{bmatrix} 0 & 0 \\ 0 & M_{ii} \end{bmatrix} \begin{Bmatrix} \dot{V}_b \\ \dot{V}_i \end{Bmatrix} + \begin{bmatrix} 0 & 0 \\ 0 & D_{ii} \end{bmatrix} \begin{Bmatrix} V_b \\ V_i \end{Bmatrix} + \begin{bmatrix} K_{bb} & K_{bi} \\ K_{ib} & K_{ii} \end{bmatrix} \begin{Bmatrix} U_b \\ U_i \end{Bmatrix} = \begin{Bmatrix} F_b(t) + W_b \lambda \\ F_i(t) \end{Bmatrix}, \quad (345)$$

or

$$[K_{bb}]\{U_b\} + [K_{bi}]\{U_i\} = \{F_b(t)\} + [W_b]\{\lambda\} \quad (346)$$

and

$$[M_{ii}]\{\dot{V}_i\} + [D_{ii}]\{V_i\} + [K_{ii}]\{U_i\} + [K_{ib}]\{U_b\} = \{F_i(t)\}. \quad (347)$$

Here, $\{\lambda\}$ represent the contact forces in the slave nodes in a local coordinate system. The size of this vector is three times the number of slave nodes. $[W_b]\{\lambda\}$ are the contact forces in all nodes (slave and master) in global coordinates. The motivation for neglecting the inertia terms at the contact boundary comes from the fact that these forces were observed to lead to substantial scatter in the solution in the contact area.

From Equation (346) one obtains for the displacements at the boundary nodes for time increment k :

$$\{U_b\}^k = [K_{bb}]^{-1} (\{F_b(t^k)\} - [K_{bi}]\{U_i\}^k + [W_b]\{\lambda\}^k) \quad (348)$$

Now, a Verlet scheme in its leapfrog form [66] is proposed based on the trapezoidal rule and a shifted grid. This means that displacements are evaluated at times t^k and t^{k+1} , while velocities are evaluated at times $t^{k-\frac{1}{2}}$ and $t^{k+\frac{1}{2}}$. Evaluating Equation (344) at time step k and using $\mathbf{v}^{k-\frac{1}{2}}$ one obtains:

$$\{\gamma\}^k = [W_b]^T \frac{(\{U_b\}^k - \{U_b\}^{k-1})}{\Delta t} + \{\dot{g}_0(t^k)\}. \quad (349)$$

and after substituting $\{U_b\}^k$:

$$\begin{aligned} \{\gamma\}^k &= \frac{1}{\Delta t} [W_b]^T [K_{bb}]^{-1} [W_b]\{\lambda\}^k \\ &+ \frac{1}{\Delta t} [W_b]^T ([K_{bb}]^{-1} (\{F_b(t^k)\} - [K_{bi}]\{U_i\}^k) - \{U_b\}^{k-1}) \\ &+ \{\dot{g}_0(t^k)\}, \end{aligned} \quad (350)$$

or, introducing the symmetric matrix $[G]$ and vector $\{c\}$:

$$\{\gamma\}^k = [G]\{\lambda\}^k + \{c\}. \quad (351)$$

So the contact constraint at time t^k (also called an inclusion problem):

$$-\gamma^k \in \mathcal{N}_{\mathcal{C}}(\boldsymbol{\lambda}^k) \quad (352)$$

now amounts to:

$$-([G]\{\lambda\}^k + \{c\}) \in \mathcal{N}_{\mathcal{C}}(\{\lambda\}^k), \quad (353)$$

or

$$\{\lambda\}^k = \text{prox}_{\mathcal{C}} [\{\lambda\}^k - ([G]\{\lambda\}^k + \{c\})]. \quad (354)$$

The latter equation can be solved in an iterative way [99]:

$$\{\lambda\}_{n+1}^k = \text{prox}_{\mathcal{C}} [\{\lambda\}_n^k - [r]([G]\{\lambda\}_n^k + \{c\})], \quad (355)$$

where $[r]$ is a diagonal matrix with relaxation factors and n is the iteration index. The relaxation factors are taken to be

$$r_{ii} = \frac{\omega}{G_{ii}} \quad \text{if } G_{ii} > \sum_{j,j \neq i} G_{ij} \quad (356)$$

$$r_{ii} = \frac{\omega}{\sum_{j,j \neq i} G_{ij}} \quad \text{if } G_{ii} \leq \sum_{j,j \neq i} G_{ij}, \quad (357)$$

where $0 \leq \omega \leq 2$ is a relaxation parameter.

Summarizing, the contact displacements in time step t^k are solved using the following steps (knowing $\{F_b(t^k)\}$, $\dot{g}_0(t^k)$, $\{U_i\}^k$ and $\{U_b\}^{k-1}$):

- determine $[G]$ and $\{c\}$ using Equations (350) and (351)
- solve for $\{\lambda\}^k$ using Equation (355) with $\{\lambda\}^{k-1}$ as initial guess.
- solve for $\{U_b\}^k$ using Equation (348).

The solution of the contact problem, however, is restricted to the active contact degrees of freedom. Indeed, only for the nodes in contact the gap velocity is positive and Figure 135 applies. The procedure to determine these active contact degrees of freedom is called an active set strategy. Two cases are considered. For the initially open case (i.e. no contact at t^{k-1}) the gap is calculated at t^k by substituting Equation (348) for $\{\lambda\}^k = 0$ into Equation (343). The active degrees of freedom are those for which the gap is nonpositive. For the preloaded case (i.e. the contact forces at t^{k-1} are positive) the preload is calculated from Equation (348) assuming sticking contact, i.e. $\{U_b\}^k = \{U_b\}^{k-1}$. Then, the active degrees of freedom are those, for which this sticking contact is changing, i.e. either the normal preload is negative or the tangential preload exceeds the sticking range and slip occurs. For details the reader is referred to [66].

Once $\{U_b\}^k$ is calculated $\{V_i\}^{k+\frac{1}{2}}$ can be calculated by substituting $\{\dot{V}_i\}^k = (\{V_i\}^{k+\frac{1}{2}} - \{V_i\}^{k-\frac{1}{2}})/\Delta t$ and $\{V_i\}^k = (\{V_i\}^{k+\frac{1}{2}} + \{V_i\}^{k-\frac{1}{2}})/2$ in Equation (347) expressed at time t^k leading to:

$$\begin{aligned} \left(\frac{[M_{ii}]}{\Delta t} + \frac{[D_{ii}]}{2} \right) \{V_i\}^{k+\frac{1}{2}} &= \{F_i(t^k)\} - [K_{ii}]\{U_i\}^k - [K_{ib}]\{U_b\}^k \\ &+ \left(\frac{[M_{ii}]}{\Delta t} - \frac{[D_{ii}]}{2} \right) \{V_i\}^{k-\frac{1}{2}}. \end{aligned} \quad (358)$$

The solution of this set of equations requires a linear equation solver. The mass matrix does not change during the calculation. If the damping matrix does not change either, the factorization step in the linear equation solver can be done just once at the start of the calculation. This drastically reduces the computation time. Knowing $\{V_i\}^{k+\frac{1}{2}}$ the value of the displacements in the internal nodes can be obtained from:

$$\{U_i\}^{k+1} = \{U_i\}^k + \{V_i\}^{k+\frac{1}{2}} \Delta t. \quad (359)$$

Consequently, the overall algorithm can be summarized as follows, knowing $\{F_b(t^k)\}$, $\dot{g}_0(t^k)$, $\{U_i\}^k$, $\{U_b\}^{k-1}$, $\{\lambda\}^{k-1}$ and $\{V_i\}^{k-\frac{1}{2}}$:

- Determine the active set
 - If the active set is empty $\{\lambda\}^k = \{0\}$ for an initially open contact, and $\{\lambda\}^k = \{\lambda^{\text{pre}}\}$ for a preloaded contact.
 - If the active set is not empty, determine $\{\lambda\}^k$ from Equation (353) with $\{\lambda\}^{k-1}$ as starting value.
- Determine $\{U_b\}^k$ from Equation (348).
- Determine $\{V_i\}^{k+\frac{1}{2}}$ from Equation (358).
- Determine $\{U_i\}^{k+1}$ from Equation (359).

In the first increment ($k=1$) $\{U_i\}^1$, $\{U_b\}^0$ and $\{V_i\}^{\frac{1}{2}}$ have to be known.

6.8 Materials

A material definition starts with a *MATERIAL key card followed by material specific cards such as *ELASTIC, *EXPANSION, *DENSITY, *HYPERELASTIC, *HYPERFOAM, *DEFORMATION PLASTICITY, *PLASTIC, *CREEP or *USER MATERIAL. To assign a material to an element, the *SOLID SECTION card is used. An element can consist of one material only. Each element in the structure must have a material assigned. Some types of loading require specific material properties: gravity loading requires the density of the material, temperature loading requires the thermal expansion coefficient. A material property can also be required by the type of analysis: a frequency analysis requires the material's density.

Some of the material cards are mutually exclusive, while others are interdependent. Exactly one of the following is required: *ELASTIC, *HYPERELASTIC, *HYPERFOAM, *DEFORMATION PLASTICITY and *USER MATERIAL. The keyword *PLASTIC must be preceded by *ELASTIC(,TYPE=ISO). The same applies to the *CREEP card. A *PLASTIC card in between the *ELASTIC and *CREEP card defines a viscoplastic material. The other keywords can be used according to your needs.

6.8.1 Linear elasticity

Linear elastic materials are characterized by an elastic potential of which only the quadratic terms in the strain are kept. It can be defined in a isotropic, orthotropic or fully anisotropic version. Isotropic linear elastic materials are characterized by their Young's modulus and Poisson's coefficient. Common steels are usually isotropic. Orthotropic materials, such as wood or cubic single

crystals are characterized by 9 nonzero constants and fully anisotropic materials by 21 constants. For elastic materials the keyword *ELASTIC is used.

A linear elastic material, as implemented in CalculiX simulates a linear elastic relationship between the Lagrange strain and the Piola-Kirchhoff stress of the second kind (PK2). For small strains and rotations, the Lagrange strain reduces to the linear strain and the PK2 stress to a generic stress tensor. For large strains and/or rotations one can prove that a linear elastic connection of the Lagrange strain and the PK2 stress does not make physically sense (cf. next section), and other relationships derived from stored-energy functions are preferred.

In Abaqus, a linear elastic material expresses a linear elastic relationship between the logarithmic strain and the Cauchy stress. If the Cauchy-Green tensor is written as

$$\mathbf{C} = \sum_{i=1}^3 \lambda_i^2 \mathbf{M}_i, \quad (360)$$

where λ_i are the three principal stretches and \mathbf{M}_i are the structural tensors (cf. [23], Equation (1.121), here reduced for a global rectangular system) then the logarithmic strain satisfies:

$$\mathbf{E}_{\ln} = \sum_{i=1}^3 \ln(\lambda_i) \mathbf{M}_i. \quad (361)$$

By defining a linear elastic material in user subroutine umat_abaqusnl.f one can simulate this behavior. In fact, the material coded as an example in umat_abaqusnl.f is exactly such material.

For finite strain (visco)plasticity, triggered by the keywords *PLASTIC and/or *CREEP in combination with the parameter NLGEOM on the *STATIC card, a hyperelastic-type potential is used for the elastic range. For details the reader is referred to [23], Section 6.3.1.

6.8.2 Linear elasticity for large strains (Ciarlet model)

In [23] it is explained that substituting the infinitesimal strains in the classical Hooke law by the Lagrangian strain and the stress by the Piola-Kirchhoff stress of the second kind does not lead to a physically sensible material law. In particular, such a model (also called St-Venant-Kirchhoff material) does not exhibit large stresses when compressing the volume of the material to nearly zero. An alternative for isotropic materials is the following stored-energy function developed by Ciarlet [18] (μ and λ are Lamé's constants):

$$\Sigma = \frac{\lambda}{4} (III_C - \ln III_C - 1) + \frac{\mu}{4} (I_C - \ln III_C - 3). \quad (362)$$

The stress-strain relation amounts to (\mathbf{S} is the Piola-Kirchhoff stress of the second kind) :

$$\mathbf{S} = \frac{\lambda}{2}(\det \mathbf{C} - 1)\mathbf{C}^{-1} + \mu(\mathbf{I} - \mathbf{C}^{-1}), \quad (363)$$

and the derivative of \mathbf{S} with respect to the Green tensor \mathbf{E} reads (component notation):

$$\frac{dS^{IJ}}{dE_{KL}} = \lambda(\det \mathbf{C})C^{-1KL}C^{-1IJ} + [2\mu - \lambda(\det \mathbf{C} - 1)]C^{-1IK}C^{-1LJ}. \quad (364)$$

This model was implemented into CalculiX by Sven Kaßbohm. The definition consists of a *MATERIAL card defining the name of the material. This name HAS TO START WITH "CIARLET_EL" but can be up to 80 characters long. Thus, the last 70 characters can be freely chosen by the user. Within the material definition a *USER MATERIAL card has to be used satisfying:

First line:

- *USER MATERIAL
- Enter the CONSTANTS parameter and its value, i.e. 2.

Following line:

- E (Young's modulus).
- ν (Poisson's coefficient).
- Temperature.

Repeat this line if needed to define complete temperature dependence. For this model, there are no internal state variables.

Example:

```
*MATERIAL,NAME=CIARLET_EL
*USER MATERIAL,CONSTANTS=2
210000.,.3,400.
```

defines an isotropic material with elastic constants $E=210000.$ and $\nu=0.3$ for a temperature of 400 (units appropriately chosen by the user). Recall that

$$\mu = \frac{E}{2(1 + \nu)} \quad (365)$$

and

$$\lambda = \frac{\nu E}{(1 + \nu)(1 - 2\nu)}. \quad (366)$$

6.8.3 Linear elasticity for rotation-insensitive small strains

This is a material formulation for very special applications. Small strains (i.e. linearized strains) are large rotation sensitive, i.e. they become nonzero if you apply a large rigid body rotation to a structure (cf [23]).

The Lagrange strain tensor satisfies:

$$2\mathbf{E} = \mathbf{F}^T \mathbf{F} - \mathbf{I}, \quad (367)$$

which can also be written as:

$$2\mathbf{E} = (\mathbf{F} - \mathbf{I})^T + (\mathbf{F} - \mathbf{I}) + (\mathbf{F} - \mathbf{I})^T (\mathbf{F} - \mathbf{I}). \quad (368)$$

\mathbf{F} is the deformation gradient and the expressions in parentheses are the gradient of the displacements. Linearizing, only the first two terms on the right hand side of the above equation are kept. This linearization, however, is not large-rotation insensitive. In order to create a rotation-insensitive linear strain, the deformation gradient is replaced by the right hand stretch tensor \mathbf{U} (recall that $\mathbf{F} = \mathbf{R}\mathbf{U}$, where \mathbf{R} is the rotation tensor):

$$2\mathbf{E} = (\mathbf{U} - \mathbf{I})^T + (\mathbf{U} - \mathbf{I}). \quad (369)$$

This strain is, although linear, large rotation insensitive. Now, what is this good for? In some applications (e.g. in linear elastic fracture mechanics) you need linear strains exhibiting the appropriate stress and strain singularities (e.g. at the crack tip). However, you would still like to include applications with large rotations. The above formulation takes care of exactly these requirements.

In order to apply this formulation in CalculiX, the user has to specify the parameter NLGEOM on the *STEP card. In those elements, in which rotation-insensitive linear strains should be used, the user has to replace the linear elastic isotropic material he/she would usually apply by the user material coded in routine umat_undo_nlgeom_lin_iso_el.f. To that end the user gives a new name to the material starting with UNDO_NLGEOM_LIN_ISO_EL. The constants of this user material are the Young's modulus and Poisson's coefficient of the original material. Suppose the original material formulation was:

```
*MATERIAL,NAME=EL
*ELASTIC
210000.,.3
```

Then, the new material is defined by:

```
*MATERIAL,NAME=UNDO_NLGEOM_LIN_ISO_ELx
*USER MATERIAL,CONSTANTS=2
210000.,.3
```

where x can be whatever character string preferred by the user, minimum 0 characters, maximum 58 characters long. Only linear elastic isotropic materials are allowed so far.

6.8.4 Ideal gas for small pressure deviations

A special case of a linear elastic isotropic material is an ideal gas for small pressure deviations. From the ideal gas equation one finds that the pressure deviation dp is related to a density change $d\rho$ by

$$dp = \frac{d\rho}{\rho_0} \rho_0 r T, \quad (370)$$

where ρ_0 is the density at rest, r is the specific gas constant and T is the temperature in Kelvin. Since $\rho V = \rho_0 V_0$ one obtains at $\rho = \rho_0$ and $V = V_0$:

$$V_0 d\rho + \rho_0 dV = 0 \quad (371)$$

from which

$$\frac{d\rho}{\rho_0} = -\frac{dV}{V_0} = -\frac{V_0(1 + \epsilon_{11})(1 + \epsilon_{22})(1 + \epsilon_{33}) - V_0}{V_0}. \quad (372)$$

From this one can derive the equations

$$-dp = dt_{11} = dt_{22} = dt_{33} = (\epsilon_{11} + \epsilon_{22} + \epsilon_{33})\rho_0 r T \quad (373)$$

and

$$dt_{12} = dt_{13} = dt_{23} = 0, \quad (374)$$

where \mathbf{t} denotes the stress and $\boldsymbol{\epsilon}$ the linear strain. This means that an ideal gas can be modeled as an isotropic elastic material with Lamé constants $\lambda = \rho_0 r T$ and $\mu = 0$. This corresponds to a Young's modulus $E = 0$ and a Poisson coefficient $\nu = 0.5$. Since the latter values lead to numerical difficulties it is advantageous to define the ideal gas as an orthotropic material with $D_{1111} = D_{2222} = D_{3333} = D_{1122} = D_{1133} = D_{2233} = \lambda$ and $D_{1212} = D_{1313} = D_{2323} = 0$.

6.8.5 Ideal gas for large deformations

An ideal gas can also be modeled as a hyperelastic material. Indeed, the ideal gas law

$$p = \rho r T = \frac{\rho_0 r T}{J} \quad (375)$$

can also be written as

$$\boldsymbol{\sigma} = -\frac{\rho_0 r T}{J} \mathbf{I}, \quad (376)$$

where $\boldsymbol{\sigma}$ is the Cauchy stress and \mathbf{I} is the identity tensor of second order. The Piola-Kirchhoff stress \mathbf{S} amounts to:

$$\mathbf{S} = J \mathbf{F}^{-1} \cdot \boldsymbol{\sigma} \cdot \mathbf{F}^{-T} = -\rho_0 r T \mathbf{F}^{-1} \cdot \mathbf{F}^{-T} = -\rho_0 r T (\mathbf{F}^T \cdot \mathbf{F})^{-1}, \quad (377)$$

or

$$\mathbf{S} = -\rho_0 r T \mathbf{C}^{-1}. \quad (378)$$

Using Equation (4.156) from [23] it is not difficult to prove that this stress can be derived from the free energy function

$$\Sigma = -\frac{1}{2} \rho_0 r T \ln(I_3) = -\rho_0 r T \ln(J), \quad (379)$$

where $I_3 = J^2$ is the third invariant of the Cauchy-Green tensor \mathbf{C} . To obtain the material stiffness $\partial \mathbf{S} / \partial \mathbf{E}$ Equation (4.163) from [23] can be used.

In CalculiX this law can be used in any mechanical calculation provided the temperature is known. It is coded as a user material in routine `umat_ideal_gas.f`. In order to use this material, the constant $\rho_0 r$ should be given underneath a `*USER MATERIAL,CONSTANTS=1` card. The name of the material has to start with `IDEAL_GAS`, the remaining 71 characters are at the free disposal of the user (a material name can be maximum 80 characters long). In addition, the parameter `NLGEOM` must be used on the `*STEP` card. Furthermore, the `*PHYSICAL CONSTANTS` card should be used to define the value of absolute zero temperature.

6.8.6 Hyperelastic and hyperfoam materials

Hyperelastic materials are materials for which a potential function exists such that the second Piola-Kirchhoff stress tensor can be written as the derivative of this potential with respect to the Lagrangian strain tensor. This definition includes linear elastic materials, although the term hyperelastic material is usually reserved for proper nonlinear elastic materials. One important class constitutes the isotropic hyperelastic materials, for which the potential function is a function of the strain invariants only. All rubber material models presently included in CalculiX are of that type (Arruda-Boyce, Mooney-Rivlin, Neo Hooke, Ogden, Polynomial, Reduced Polynomial and Yeoh). They are selected by the keyword `*HYPERELASTIC`. Rubber materials are virtually incompressible (virtually no dependence on the third Lagrangian strain invariant which takes values close to 1). The dependence on the third invariant (the compressibility) is separated from the dependence on the first two invariants and is governed by so called compressibility coefficients, taking the value 0 for perfectly incompressible materials. Perfectly incompressible materials require the use of hybrid finite elements, in which the pressure is taken as an additional independent variable (in addition to the displacements). CalculiX does not provide such elements. Consequently, a slight amount of compressibility is required for CalculiX to work. If the user inserts zero compressibility coefficients, CalculiX uses a default value corresponding to an initial value of the Poisson coefficient of 0.475.

Another example of isotropic hyperelastic materials are the hyperfoam materials, which are also implemented in CalculiX (activated by the keyword `*HYPERFOAM`). Hyperfoam materials are very compressible.

Other materials frequently simulated by a hyperelastic model are human tissue (lung tissue, heart tissue..). To simulate these classes of materials anisotropic hyperelastic models are used, in which the potential function depends on the Lagrangian strain tensor components. No such models are implemented in CalculiX, although their inclusion is not difficult to manage. For further information the reader is referred to [8]. A very nice treatment of the large deformation theory for hyperelastic materials is given in [88].

6.8.7 Deformation plasticity

Deformation plasticity is characterized by a one-to-one (bijective) relationship between the strain and the stress. This relationship is a three-dimensional generalization of the one-dimensional Ramberg-Osgood law frequently used for metallic materials (e.g. in the simple tension test) yielding a monotonic increasing function of the stress as a function of the strain. Because tensile and compressive test results coincide well when plotting the Cauchy (true) stress versus the logarithmic strain, these quantities are generally used in the deformation plasticity law. The implementation in CalculiX (keyword card *DEFORMATION PLASTICITY) implicitly uses the Abaqus interface in CalculiX for large deformations. The three-dimensional extension of the Ramberg-Osgood law reads [1]:

$$E\mathbf{e}_{\ln} = (1 + \nu)\mathbf{s} - (1 - 2\nu)p\mathbf{i} + \frac{3}{2}\alpha\left(\frac{q}{\sigma_0}\right)^{n-1}\mathbf{s}, \quad (380)$$

where \mathbf{e}_{\ln} is the logarithmic strain (cf. beginning of Section 6), $\boldsymbol{\sigma}$ is the Cauchy stress, \mathbf{i} is the identity tensor in spatial coordinates, $p := -\boldsymbol{\sigma} : \mathbf{i}/3$ is the pressure, $\mathbf{s} = \boldsymbol{\sigma} + p\mathbf{i}$ is the stress deviator and $q = \sqrt{3\mathbf{s} : \mathbf{s}}/2$ is the von Mises stress. E and ν are Young's modulus and Poisson's coefficient, respectively (cf. *DEFORMATION PLASTICITY for the one-dimensional form).

The user should give the Ramberg-Osgood material constants σ_0 , n and α directly (by plotting a Cauchy stress versus logarithmic strain curve and performing a fit).

6.8.8 Incremental (visco)plasticity: multiplicative decomposition

The implementation of incremental plasticity for nonlinear geometrical calculations in CalculiX follows the algorithms in [89] and [90] and is based on the notion of an intermediate stress-free configuration. The deformation is viewed as a plastic flow due to dislocation motion followed by elastic stretching and rotation of the crystal lattice. This is synthesized by a local multiplicative decomposition of the deformation gradient $\mathbf{F} = \mathbf{F}^e\mathbf{F}^p$ where $F_{kK} = x_{k,K}$ in Cartesian coordinates.

In the present implementation, the elastic response is isotropic and is deduced from a stored-energy function (hyperelastic response). Furthermore, the

plastic flow is isochoric (the volume is conserved) and the classical von Mises-Huber yield condition applies. This condition can be visualized as a sphere in principal deviatoric stress space.

The hardening can consist of isotropic hardening, resulting in an expansion or contraction of the yield surface, of kinematic hardening, resulting in a translation of the yield surface, or of a combination of both. The hardening curve should yield the von Mises true stress versus the equivalent plastic logarithmic strain (cf. deformation plasticity for its definition).

Incremental plasticity is defined by the *PLASTIC card, followed by the isotropic hardening curve for isotropic hardening or the kinematic hardening curve for kinematic and combined hardening. For combined hardening, the isotropic hardening curve is defined by the *CYCLIC HARDENING card. The *PLASTIC card should be preceded within the same material definition by an *ELASTIC card, defining the isotropic elastic properties of the material.

By allowing the stress to leave the yield surface temporarily in order to regain it with time, creep effects can be modeled [87]. The viscous part of the viscoplastic law is defined by the *CREEP card. Default is a Norton type law. However, the user can also define his own law in user subroutine creep.f. If the *CREEP card is not preceded by a *PLASTIC card, a zero yield surface without any hardening effects is assumed. The *CREEP card must be preceded by an *ELASTIC card defining the isotropic elastic properties of the material. Notice that creep behavior is switched off in a *STATIC step.

For this model, there are 13 internal state variables:

- the accumulated equivalent plastic strain \bar{e}^p (1)
- the unit tensor minus the inverse plastic right Cauchy-Green tensor and divided by two $(\mathbf{I} - \mathbf{C}^p)^{-1}/2$. For small deformations the resulting tensor coincides with the infinitesimal plastic strain tensor ϵ^p (6)
- the back stress Γ (6)

These variables are accessible through the *EL PRINT (.dat file) and *EL FILE (.frd file) keywords in exactly this order (label SDV).

By using the *CHANGE MATERIAL, *CHANGE PLASTIC, *STATIC and *VISCO cards the user can switch between a purely plastic and creep behavior. The viscoplastic model implemented in CalculiX is an overstress model, i.e. creep only occurs above the yield stress. For a lot of materials this is not realistic. At high temperatures creep is frequently observed well below the yield stress. To simulate this behavior one can set the yield stress to zero. In order to simulate an initial large plastic deformation (e.g. due to forging or other machining operations) followed by creep at high temperature at operation conditions one can proceed as follows: one defines the material as a viscoplastic material using the *PLASTIC and *CREEP card. To switch off the creep behavior in the machining step one uses the *STATIC procedure. In a subsequent step at operating conditions the viscous behavior is switched on using the *VISCO procedure whereas the yield stress is set to zero by means of a *CHANGE MATERIAL and *CHANGE PLASTIC card.

6.8.9 Incremental (visco)plasticity: additive decomposition

The implementation of incremental plasticity for linear geometrical calculations in CalculiX follows the algorithms in [23], section 5.3 and is based on an additive decomposition of the strain tensor into an elastic and a plastic part. In CalculiX, it is used in the absence of the NLGEOM parameter on the *STEP card. The internal variables are the same as for the multiplicative decomposition (cf. previous section) in their infinitesimal limit. It seems that the additive decomposition exhibits less convergence issues than the multiplicative decomposition (although this may also be attributable to the general nonlinear geometrical setup).

6.8.10 Plasticity with Johnson-Cook hardening.

In some sense this is a special case of the previous section, however, since it has been implemented as a Abaqus Material User Subroutine in CalculiX, establishing a relationship between the corotational Cauchy stress and the corotational logarithmic strain it can also be used for large deformations.

In principal, the Johnson-Cook model [40] proposes a yield curve for a conventional plasticity model with isotropic hardening in the form:

$$\sigma_{vm} = [A + B\epsilon_p^n] \left[1 + C \ln \left(\frac{\dot{\epsilon}_p}{\dot{\epsilon}_0} \right) \right] [1 - (T^*)^m], \quad (381)$$

where

$$\begin{aligned} T^* &= 0 && \text{for } T < T_0 \\ T^* &= \left(\frac{T - T_0}{T_m - T_0} \right) && \text{for } T_0 \leq T \leq T_m \\ T^* &= 1 && \text{for } T > T_m \end{aligned} \quad (382)$$

Here, $A, B, C, n, m, \dot{\epsilon}_0, T_0$ and T_m are material constants. The constant T_0 has the physical meaning of transition temperature, i.e. the temperature above which the yield surface starts to shrink and T_m has the physical meaning of melt temperature, i.e. the temperature above which the yield surface is reduced to zero. The model is meant to describe highly dynamical phenomena such as explosions, bird strike in a jet engine etc.

For $\dot{\epsilon}_p < \dot{\epsilon}_0$ the logarithm becomes negative and also for small ϵ_p convergence seems more difficult. Therefore, Bernhardt and co-workers [54] have modified the above law to:

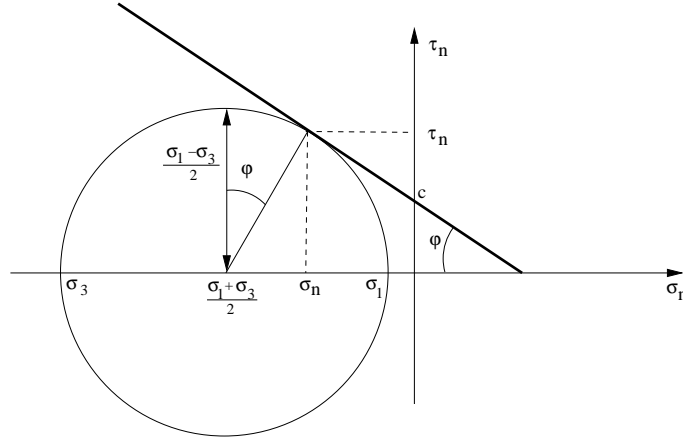

Figure 140: Mohr-Coulomb yield surface

$$\begin{aligned}\sigma_{vm} &= [A + B\epsilon_p\delta^{n-1}] \left[1 + C \ln \left(\frac{\dot{\epsilon}_p}{\dot{\epsilon}_0} \right) \right] f(T^*) \quad \dot{\epsilon}_p \geq \dot{\epsilon}_0, \epsilon_p \leq \delta \\ \sigma_{vm} &= [A + B\epsilon_p^n] \left[1 + C \left(\frac{\dot{\epsilon}_p}{\dot{\epsilon}_0} - 1 \right) \right] f(T^*) \quad \dot{\epsilon}_p < \dot{\epsilon}_0, \epsilon_p > \delta \\ \sigma_{vm} &= [A + B\epsilon_p\delta^{n-1}] \left[1 + C \left(\frac{\dot{\epsilon}_p}{\dot{\epsilon}_0} - 1 \right) \right] f(T^*) \quad \dot{\epsilon}_p < \dot{\epsilon}_0, \epsilon_p \leq \delta \quad (383)\end{aligned}$$

where $f(T^*) := 1 - (T^*)^m$ and δ is some small number. In CalculiX $\delta = 10^{-4}$ was taken.

In the input deck the Johnson-Cook model is activated by the HARDENING=JOHNSON COOK parameter on the *PLASTIC card. Underneath this card the rate-independent terms are defined, i.e. the parameters A, B, n, m, T_m and T_0 . If $T_m = T_0$ no temperature dependence is taken into account. The rate dependence has to be defined using a *RATE DEPENDENT card with the parameter TYPE=JOHNSON COOK, listing underneath the parameters C and $\dot{\epsilon}_0$.

6.8.11 Mohr-Coulomb plasticity.

The theory and algorithms used to code the classical Mohr-Coulomb plasticity model are primarily taken from [97] and [20] and the references therein.

The Mohr-Coulomb plasticity is non-associative with a piecewise linear yield surface f and a piecewise linear plastic potential g . The basic idea is that the shear stress at which plastic flow occurs increases with increasing pressure, similar to contact sliding. This is illustrated in Figure 140 showing the shear stress τ versus normal stress σ_n . $\sigma_1 \geq \sigma_2 \geq \sigma_3$ are the principal stresses.

The yield surface satisfies:

$$\tau = c - \sigma_n \tan \varphi, \quad (384)$$

where c is the cohesion. This is equivalent to (cf. Figure 140)

$$\sigma_1 \left(\frac{1 + \sin \varphi}{1 - \sin \varphi} \right) - \sigma_3 - 2c \frac{\cos \varphi}{1 - \sin \varphi} = 0, \quad (385)$$

or

$$k\sigma_1 - \sigma_3 - 2c\sqrt{k} = 0, \quad (386)$$

where

$$k = \frac{1 + \sin \varphi}{1 - \sin \varphi}. \quad (387)$$

φ is called the friction angle. Similarly, the plastic potential is defined by:

$$g = m\sigma_1 - \sigma_3, \quad (388)$$

where

$$m = \frac{1 + \sin \psi}{1 - \sin \psi}. \quad (389)$$

ψ is called the dilation angle. It describes to what extent the volume of the material changes due to shear motion. For a positive value of ψ the volume increases, as for dense sand. For a negative value the volume decreases, as for loose sand. In the latter case the grains fit better due to the motion. You can easily illustrate this by pouring sugar in a bowl. Shaking the bowl the volume will decrease and more sugar will fit.

As mentioned, the yield surface is piecewise linear, so the gradient of the surface is not continuous. This complicates matters. Now, looking at the yield surface and plastic potential it can be observed that it contains only principal stresses. Assuming the material to be elastically isotropic, this allows us to perform all operations in principal stress space, thereby reducing the tensors to vectors. This was first proposed in [19].

Replacing $\sigma_1, \sigma_2, \sigma_3$ by x, y, z for simplicity, the yield surface as defined in Equation (386) defines in three-dimensional space one of six faces of a irregular pyramid with central axis in $(1, 1, 1)$ direction. The other faces correspond to sectors in which the order of $\sigma_1, \sigma_2, \sigma_3$ is different.

Figure 141 shown a view on a plane orthogonal to the $(1, 1, 1)$ axis and through the origin. The six sectors are bordered by planes going through the x -, y - and z - axes and containing the $(1, 1, 1)$ -axis. The cross section of this plane with the yield surface is an irregular hexagon (dashed line). Since the principal stresses can always be rearranged such that $x \geq y \geq z$ it is sufficient to look at that sector (labeled 1) and the neighboring ones (labeled 6 and 2).

Figure 142 shows the yield surface viewed from the apex and looking in the direction of $(-1, -1, -1)$. In the sectors of interest the normal to the surface \mathbf{a}

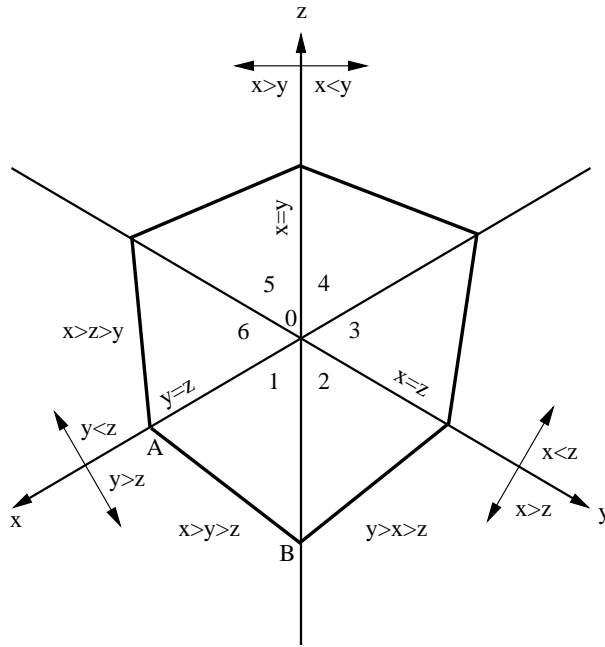

Figure 141: Section plane $\perp (1,1,1)$ through $(0,0,0)$

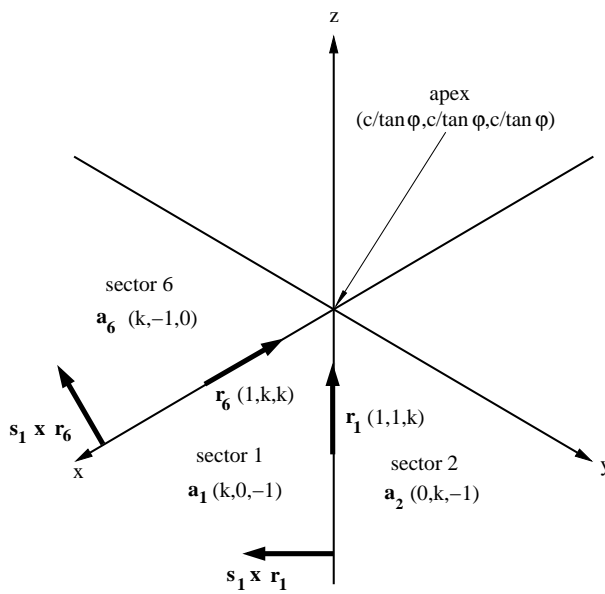

Figure 142: Pressure distribution in the lid-driven cavity

is shown. For sector 1 this is immediately clear from Equation (386) which can be written as $(k, 0, -1) \cdot (\sigma_1, \sigma_2, \sigma_3) - 2c\sqrt{k} = 0$. A vector along the intersection lines of the pyramid faces is obtained by taking the cross product of the normal of the neighboring faces, e.g. $\mathbf{r}_6 = \mathbf{a}_6 \times \mathbf{a}_1$. The apex of the pyramid is obtained by substituting $\sigma_1 = \sigma_3$ in Equation (386): it yields

$$s_a := \sigma_1 = \sigma_2 = \sigma_3 = \frac{2c\sqrt{k}}{k-1} = \frac{c}{\tan \varphi}. \quad (390)$$

Therefore, the equation of the intersection line between section 6 and 1 satisfied $(s_a, s_a, s_a) + \lambda(1, k, k)$. Its intersection with the plane $x + y + z = 0$ leads to

$$\lambda = \frac{3s_a}{1+2k}, \quad (391)$$

yielding the location of point A in Figure 141. For point B one gets

$$\lambda = \frac{3s_a}{2+k}, \quad (392)$$

which is farther away from the origin since $k \geq 1$. The normal to the plastic potential surface is labeled \mathbf{b} and amounts for sector 1 to $(m, 0, -1)$. Similar expressions apply to the other sectors.

The governing equations of an elastic material with Mohr-Coulomb plasticity read:

(i) Elastic stress-strain relations

$$\boldsymbol{\sigma} = \mathbf{D} \cdot \boldsymbol{\epsilon}^e \quad (393)$$

(ii) Internal variable relationship

$$c(\epsilon^{\text{peq}}) \quad (394)$$

(iii) Yield surface

$$f(\boldsymbol{\sigma}, c) = 0 \Leftrightarrow \mathbf{a} \cdot \boldsymbol{\sigma} - 2c\sqrt{k} = 0 \quad (395)$$

(iv) Evolution equations

$$\dot{\boldsymbol{\epsilon}}^p = \dot{\gamma} \frac{\partial g(\boldsymbol{\sigma}, c)}{\partial \boldsymbol{\sigma}} = \dot{\gamma} \mathbf{b} \quad (396)$$

(v) Kuhn-Tucker equations

$$\dot{\gamma} \geq 0, \quad f(\boldsymbol{\sigma}, c) \leq 0, \quad \dot{\gamma} f(\boldsymbol{\sigma}, c) = 0 \quad (397)$$

(vi) Consistency condition

$$\dot{\gamma} f(\boldsymbol{\sigma}, c) = 0. \quad (398)$$

Notice that in the above equations $\boldsymbol{\sigma}$ and $\boldsymbol{\epsilon}$ are vectors in principal space.

In order to explain the numerical procedure it is assumed that all variables are known at the end of increment n (corresponding to time t) and that their values are sought at the end of increment $n + 1$ (corresponding to time $t + \Delta t$). The input to the algorithm is a change on total strain $\Delta \boldsymbol{\epsilon}$.

At first it is assumed that now plasticity occurs in the new increment, i.e.:

$$\boldsymbol{\epsilon}_{n+1}^p = \boldsymbol{\epsilon}_n^p \quad (399)$$

$$c_{n+1} = c_n \quad (400)$$

$$\gamma_{n+1} = \gamma_n \quad (401)$$

$$\boldsymbol{\sigma}_{n+1} = \mathbf{D} \cdot (\boldsymbol{\epsilon}_n^e + \Delta \boldsymbol{\epsilon}) \quad (402)$$

If

$$\mathbf{a} \cdot \boldsymbol{\sigma}_{n+1} - 2c_{n+1} \sqrt{k} \leq 0, \quad (403)$$

the solution is found. If not, $\Delta \gamma_{n+1} := \gamma_{n+1} - \gamma_n > 0$ and due to the Kuhn-Tucker equations $f(\boldsymbol{\sigma}, c) = 0$ is required. The stress at $n + 1$ can be written as:

$$\boldsymbol{\sigma}_{n+1} = \mathbf{D} \cdot \boldsymbol{\epsilon}_{n+1}^e \quad (404)$$

$$= \mathbf{D} \cdot (\boldsymbol{\epsilon}_{n+1} - \boldsymbol{\epsilon}_{n+1}^p) \quad (405)$$

$$= \mathbf{D} \cdot (\boldsymbol{\epsilon}_{n+1} - \boldsymbol{\epsilon}_n^p + \boldsymbol{\epsilon}_n^p - \boldsymbol{\epsilon}_{n+1}^p) \quad (406)$$

$$= \boldsymbol{\sigma}_{n+1}^{\text{trial}} - \mathbf{D} \cdot \Delta \boldsymbol{\epsilon}_{n+1}^p \quad (407)$$

$$= \boldsymbol{\sigma}_{n+1}^{\text{trial}} - \Delta \gamma \mathbf{D} \cdot \mathbf{b}. \quad (408)$$

In the last equation the evolution equation was used (flow rule). Defining $\mathbf{s} := \mathbf{D} \cdot \mathbf{b}$, satisfying the yield surface now requires:

$$\mathbf{a} \cdot (\boldsymbol{\sigma}_{n+1}^{\text{trial}} - \Delta \gamma_{n+1} \mathbf{s}) - 2c(\epsilon_{n+1}^{\text{peq}}) \sqrt{k} = 0. \quad (409)$$

Notice that \mathbf{s} points in the direction of the stress correction w.r.t. the trial stress. In order to solve this equation a relationship between $\epsilon_{n+1}^{\text{peq}}$ and $\Delta \gamma$ is needed. Now, $\dot{\epsilon}_{n+1}^{\text{peq}}$ is defined as:

$$\dot{\epsilon}_{n+1}^{\text{peq}} = \sqrt{\frac{2}{3}} \|\dot{\boldsymbol{\epsilon}}_{n+1}^p\|, \quad (410)$$

from which:

$$\epsilon_{n+1}^{\text{peq}} = \int_0^{t+\Delta t} \sqrt{\frac{2}{3}} \|\dot{\epsilon}^p\| dt \quad (411)$$

$$= \int_0^t \sqrt{\frac{2}{3}} \|\dot{\epsilon}^p\| dt + \int_t^{t+\Delta t} \sqrt{\frac{2}{3}} \|\dot{\epsilon}^p\| dt \quad (412)$$

$$= \epsilon_n^{\text{peq}} + \sqrt{\frac{2}{3}} \|\Delta \epsilon_{n+1}^p\| \quad (413)$$

$$= \epsilon_n^{\text{peq}} + \sqrt{\frac{2}{3}} \Delta \gamma_{n+1} \|\mathbf{b}\| \quad (414)$$

$$= \epsilon_n^{\text{peq}} + \sqrt{\frac{2}{3}} \Delta \gamma_{n+1} \sqrt{1+m^2} \quad (415)$$

Defining $k^* := 2\sqrt{k}$ and $m^* := \sqrt{2(1+m^2)}/3$ the yield equation now amounts to:

$$f = \mathbf{a} \cdot (\boldsymbol{\sigma}_{n+1}^{\text{trial}} - \Delta \gamma_{n+1} \mathbf{s}) - k^* c(\epsilon_n^{\text{peq}} + \Delta \gamma_{n+1} m^*) = 0. \quad (416)$$

This is a nonlinear equation in $\Delta \gamma_{n+1}$. Using the Newton-Raphson procedure the first derivative is needed, which yields:

$$\frac{\partial f}{\partial \Delta \gamma_{n+1}} = -\mathbf{a} \cdot \mathbf{s} - k^* m^* \frac{\partial c}{\partial \epsilon_{n+1}^{\text{peq}}}. \quad (417)$$

Starting with an initial guess $\Delta \gamma_{n+1}^0 = 0$, one arrives at $\Delta \gamma_{n+1}^{(k+1)} = \Delta \gamma_{n+1}^{(k)} + \Delta \Delta \gamma_{n+1}^{(k)}$ by solving the equation:

$$f(\Delta \gamma_{n+1}^{(k)} + \Delta \Delta \gamma_{n+1}^{(k)}) \approx f(\Delta \gamma_{n+1}^{(k)}) + f'(\Delta \gamma_{n+1}^{(k)}) \Delta \Delta \gamma_{n+1}^{(k)} = 0, \quad (418)$$

or

$$\left[-\mathbf{a} \cdot \mathbf{s} - k^* m^* \frac{\partial c}{\partial \epsilon_{n+1}^{\text{peq}}} \Big|_{\epsilon_{n+1}^{\text{peq},(k)}} \right] \Delta \Delta \gamma_{n+1}^{(k)} = \mathbf{a} \cdot [\boldsymbol{\sigma}_{n+1}^{\text{trial}} - \Delta \gamma_{n+1}^{(k)} \mathbf{s}] - k^* c(\epsilon_{n+1}^{\text{peq},(k)}), \quad (419)$$

where

$$\epsilon_{n+1}^{\text{peq},(k)} = \epsilon_n^{\text{peq}} + m^* \Delta \gamma_{n+1}^{(k)}. \quad (420)$$

This works as long as the return is to a face of the yield surface. Since the return vector for sector 1 is $\mathbf{s}_1 = \mathbf{D} \cdot \mathbf{b}_1$ one can graphically plot the region in three-dimensional principal stress space which is returned to the yield face in sector 1 (Figure 143). It is the space for which

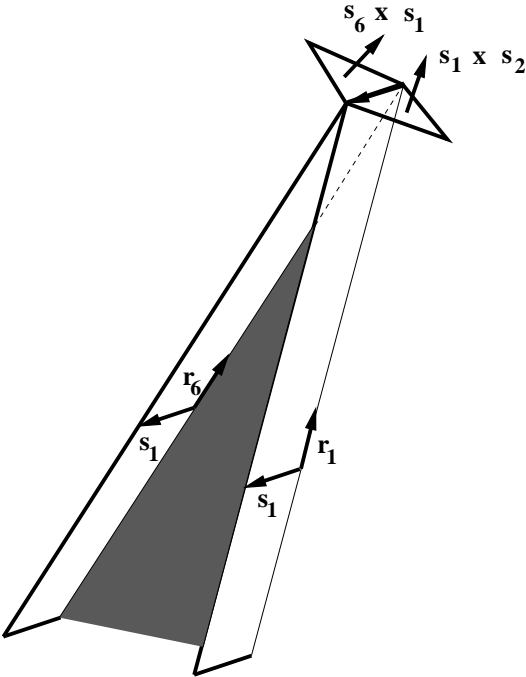

Figure 143: Limits of the return regions for Mohr-Coulomb

$$(\boldsymbol{\sigma}_{n+1}^{\text{trial}} - \mathbf{s}_a) \cdot (\mathbf{s}_1 \times \mathbf{r}_1) \geq 0 \quad \text{AND} \quad (\boldsymbol{\sigma}_{n+1}^{\text{trial}} - \mathbf{s}_a) \cdot (\mathbf{s}_1 \times \mathbf{r}_6) \leq 0. \quad (421)$$

This is called region I. The space within sector 1 in between region I and sector 2 and underneath the apex is mapped onto the intersection line of face 1 and face 2 of the yield surface (characterized by the equation $\mathbf{s}_a + \lambda \mathbf{r}_1, \lambda \in \mathbb{R}$). It is characterized by the equations

$$(\boldsymbol{\sigma}_{n+1}^{\text{trial}} - \mathbf{s}_a) \cdot (\mathbf{s}_1 \times \mathbf{r}_1) \leq 0 \quad \text{AND} \quad (\boldsymbol{\sigma}_{n+1}^{\text{trial}} - \mathbf{s}_a) \cdot (\mathbf{s}_1 \times \mathbf{s}_2) \leq 0. \quad (422)$$

and is called region II of sector 1. Similary for the space in between region I and sector 6 and underneath the apex satisfying

$$(\boldsymbol{\sigma}_{n+1}^{\text{trial}} - \mathbf{s}_a) \cdot (\mathbf{s}_1 \times \mathbf{r}_6) \geq 0 \quad \text{AND} \quad (\boldsymbol{\sigma}_{n+1}^{\text{trial}} - \mathbf{s}_a) \cdot (\mathbf{s}_6 \times \mathbf{s}_1) \leq 0. \quad (423)$$

This is region III. Finally, the region above the apex corresponding to

$$(\boldsymbol{\sigma}_{n+1}^{\text{trial}} - \mathbf{s}_a) \cdot (\mathbf{s}_1 \times \mathbf{s}_2) \geq 0 \quad \text{AND} \quad (\boldsymbol{\sigma}_{n+1}^{\text{trial}} - \mathbf{s}_a) \cdot (\mathbf{s}_6 \times \mathbf{s}_1) \geq 0 \quad (424)$$

is returned to the apex and is called region IV.

Returning the trial stress to the intersection line of two yield faces implies that the final state has to satisfy both face equations. The equivalent plastic strain now satisfies:

$$\epsilon_{n+1}^{\text{peq}} = \epsilon_n^{\text{peq}} + m^* (\Delta\gamma_{1,n+1} + \Delta\gamma_{2,n+1}) \quad (425)$$

and the yield surface equations amount to:

$$\mathbf{a}_1 \cdot (\boldsymbol{\sigma}_{n+1}^{\text{trial}} - \Delta\gamma_{1,n+1} \mathbf{s}_1 - \Delta\gamma_{2,n+1} \mathbf{s}_2) - k^* c(\epsilon_{n+1}^{\text{peq}}) = 0 \quad (426)$$

$$\mathbf{a}_2 \cdot (\boldsymbol{\sigma}_{n+1}^{\text{trial}} - \Delta\gamma_{1,n+1} \mathbf{s}_1 - \Delta\gamma_{2,n+1} \mathbf{s}_2) - k^* c(\epsilon_{n+1}^{\text{peq}}) = 0. \quad (427)$$

Applying Newton-Raphson now leads to:

$$[A] \cdot \left\{ \begin{array}{c} \Delta\Delta\gamma_1 \\ \Delta\Delta\gamma_2 \end{array} \right\}_{n+1}^{(k)} = \{B\}, \quad (428)$$

where

$$[A] = \left[\begin{array}{cc} -\mathbf{a}_1 \cdot \mathbf{s}_1 - k^* m^* \frac{\partial c}{\partial \epsilon^{\text{peq}}} \Big|_{\epsilon_{n+1}^{\text{peq},(k)}} & -\mathbf{a}_1 \cdot \mathbf{s}_2 - k^* m^* \frac{\partial c}{\partial \epsilon^{\text{peq}}} \Big|_{\epsilon_{n+1}^{\text{peq},(k)}} \\ -\mathbf{a}_2 \cdot \mathbf{s}_1 - k^* m^* \frac{\partial c}{\partial \epsilon^{\text{peq}}} \Big|_{\epsilon_{n+1}^{\text{peq},(k)}} & -\mathbf{a}_2 \cdot \mathbf{s}_2 - k^* m^* \frac{\partial c}{\partial \epsilon^{\text{peq}}} \Big|_{\epsilon_{n+1}^{\text{peq},(k)}} \end{array} \right] \quad (429)$$

and

$$\{B\} = \left\{ \begin{array}{l} \mathbf{a}_1 \cdot \left[\boldsymbol{\sigma}_{n+1}^{\text{trial}} - \Delta\gamma_{1,n+1}^{(k)} \mathbf{s}_1 - \Delta\gamma_{2,n+1}^{(k)} \mathbf{s}_2 \right] - k^* c(\epsilon_{n+1}^{\text{peq},(k)}) \\ \mathbf{a}_2 \cdot \left[\boldsymbol{\sigma}_{n+1}^{\text{trial}} - \Delta\gamma_{1,n+1}^{(k)} \mathbf{s}_1 - \Delta\gamma_{2,n+1}^{(k)} \mathbf{s}_2 \right] - k^* c(\epsilon_{n+1}^{\text{peq},(k)}) \end{array} \right\}. \quad (430)$$

For a return to the apex the yield equations of sector 1, 2 and 6 have to be satisfied yielding 3 equations in 3 unknowns.

To calculate the consistent tangent the change of stress due to a change in total strain is needed. The change of stress in the present increment amounts to:

$$d(\boldsymbol{\Delta}\boldsymbol{\sigma}) = d(\mathbf{D} \cdot \boldsymbol{\Delta}\boldsymbol{\epsilon}^e) \quad (431)$$

$$= d(\mathbf{D} \cdot \boldsymbol{\Delta}\boldsymbol{\epsilon} - \mathbf{D} \cdot \boldsymbol{\Delta}\boldsymbol{\epsilon}^p) \quad (432)$$

$$= d(\mathbf{D} \cdot \boldsymbol{\Delta}\boldsymbol{\epsilon} - \mathbf{D} \cdot \frac{\partial g}{\partial \boldsymbol{\sigma}} \Delta\gamma) \quad (433)$$

$$= \mathbf{D} \cdot d\boldsymbol{\Delta}\boldsymbol{\epsilon} - \mathbf{D} \cdot \frac{\partial^2 g}{\partial \boldsymbol{\sigma}^2} \cdot d\boldsymbol{\Delta}\boldsymbol{\sigma} \Delta\gamma - \mathbf{D} \cdot \frac{\partial g}{\partial \boldsymbol{\sigma}} d\Delta\gamma \quad (434)$$

$$= \mathbf{D} \cdot d\boldsymbol{\Delta}\boldsymbol{\epsilon} - s d\Delta\gamma \quad (435)$$

Now, a relationship between $d\Delta\gamma$ and $d\boldsymbol{\Delta}\boldsymbol{\epsilon}$ is needed. This is obtained from the yield equation:

$$f(\boldsymbol{\sigma}_n + \boldsymbol{\Delta}\boldsymbol{\sigma}, c(\gamma + \Delta\gamma)) = 0, \quad (436)$$

from which

$$\frac{\partial f}{\partial \boldsymbol{\sigma}} \Big|_{\boldsymbol{\sigma}_n + \boldsymbol{\Delta}\boldsymbol{\sigma}} \cdot d\boldsymbol{\Delta}\boldsymbol{\sigma} + \frac{\partial f}{\partial c} \frac{\partial c}{\partial \gamma} \Big|_{\gamma + \Delta\gamma} d\Delta\gamma = 0. \quad (437)$$

Substituting the previously obtained expression for $d(\boldsymbol{\Delta}\boldsymbol{\sigma})$ yields (dropping the bound of the derivatives to simplify the notation; the derivatives are to be taken at the end of the present increment):

$$\frac{\partial f}{\partial \boldsymbol{\sigma}} \cdot \mathbf{D} \cdot d\boldsymbol{\Delta}\boldsymbol{\epsilon} - \frac{\partial f}{\partial \boldsymbol{\sigma}} \cdot s d\Delta\gamma + \frac{\partial f}{\partial c} \frac{\partial c}{\partial \gamma} d\Delta\gamma = 0 \quad (438)$$

from which

$$d\Delta\gamma = \frac{\mathbf{a} \cdot \mathbf{D} \cdot d\boldsymbol{\Delta}\boldsymbol{\epsilon}}{\mathbf{a} \cdot \mathbf{s} + k^* m^* \frac{\partial c}{\partial \epsilon^{\text{peq}}}}. \quad (439)$$

Finally one obtains for the elastoplastic consistent tangent

$$\mathbf{D}^{ep} = \mathbf{D} - \frac{\mathbf{s} \otimes \mathbf{a} \cdot \mathbf{D}}{\mathbf{a} \cdot \mathbf{s} + k^* m^* \frac{\partial c}{\partial \epsilon^{\text{peq}}}}. \quad (440)$$

The derivation of the elastoplastic consistent tangent for a return to the intersection between face 1 and face 2 is similar. Now, a change in stress increment amounts to:

$$d\Delta\boldsymbol{\sigma} = \mathbf{D} \cdot d\Delta\boldsymbol{\epsilon} - \mathbf{D} \cdot \mathbf{b}_1 d\Delta\gamma_1 - \mathbf{D} \cdot \mathbf{b}_2 d\Delta\gamma_2. \quad (441)$$

A relationship between the change in $\Delta\gamma$ and the change in $\Delta\boldsymbol{\epsilon}$ can again be obtained by considering the adjacent yield faces ($i=1,2$):

$$f_i(\boldsymbol{\sigma}_n + \Delta\boldsymbol{\sigma}, c(\gamma + \Delta\gamma_1 + \Delta\gamma_2)) = 0, \quad (442)$$

from which

$$\left. \frac{\partial f_i}{\partial \boldsymbol{\sigma}} \right|_{\boldsymbol{\sigma}_n + \Delta\boldsymbol{\sigma}} \cdot d\Delta\boldsymbol{\sigma} + \left. \frac{\partial f_i}{\partial c} \frac{\partial c}{\partial \gamma} \right|_{\gamma + \Delta\gamma_1 + \Delta\gamma_2} d\Delta\gamma_1 + \left. \frac{\partial f_i}{\partial c} \frac{\partial c}{\partial \gamma} \right|_{\gamma + \Delta\gamma_1 + \Delta\gamma_2} d\Delta\gamma_2 = 0 \quad (443)$$

or

$$\begin{bmatrix} \mathbf{a}_1 \cdot \mathbf{s}_1 + k^* m^* \frac{\partial c}{\partial \epsilon^{\text{peq}}} & \mathbf{a}_1 \cdot \mathbf{s}_2 + k^* m^* \frac{\partial c}{\partial \epsilon^{\text{peq}}} \\ \mathbf{a}_2 \cdot \mathbf{s}_1 + k^* m^* \frac{\partial c}{\partial \epsilon^{\text{peq}}} & \mathbf{a}_2 \cdot \mathbf{s}_2 + k^* m^* \frac{\partial c}{\partial \epsilon^{\text{peq}}} \end{bmatrix} \cdot \begin{Bmatrix} d\Delta\gamma_1 \\ d\Delta\gamma_2 \end{Bmatrix} = \begin{Bmatrix} \mathbf{a}_1 \cdot \mathbf{D} \cdot d\Delta\boldsymbol{\epsilon} \\ \mathbf{a}_2 \cdot \mathbf{D} \cdot d\Delta\boldsymbol{\epsilon} \end{Bmatrix}. \quad (444)$$

Denoting the inverse of the left hand matrix by $[B]$ the solution of the above system can be written as:

$$d\Delta\gamma_1 = B_{11} \mathbf{a}_1 \cdot \mathbf{D} \cdot d\Delta\boldsymbol{\epsilon} + B_{12} \mathbf{a}_2 \cdot \mathbf{D} \cdot d\Delta\boldsymbol{\epsilon} \quad (445)$$

$$d\Delta\gamma_2 = B_{12} \mathbf{a}_1 \cdot \mathbf{D} \cdot d\Delta\boldsymbol{\epsilon} + B_{22} \mathbf{a}_2 \cdot \mathbf{D} \cdot d\Delta\boldsymbol{\epsilon}, \quad (446)$$

leading to:

$$\mathbf{D}^{ep} = \mathbf{D} - B_{11} \mathbf{s}_1 \otimes \mathbf{a}_1 \cdot \mathbf{D} - B_{11} \mathbf{s}_1 \otimes \mathbf{a}_2 \cdot \mathbf{D} - B_{11} \mathbf{s}_2 \otimes \mathbf{a}_1 \cdot \mathbf{D} - B_{11} \mathbf{s}_2 \otimes \mathbf{a}_2 \cdot \mathbf{D}. \quad (447)$$

The derivation for the return to the apex is similar (now three equations have to be satisfied).

The tangent derived here only applies to the normal directions. It has to be complemented by a shear part \hat{T} in the form [19]:

$$\mathbf{C} = \begin{bmatrix} \mathbf{D}^{ep} & 0 \\ 0 & \hat{T} \end{bmatrix} \quad (448)$$

where

$$\hat{T} = \begin{bmatrix} \frac{\sigma_{1,n+1} - \sigma_{2,n+1}}{\sigma_{1,n+1}^{\text{trial}} - \sigma_{2,n+1}^{\text{trial}}} & 0 & 0 \\ 0 & \frac{\sigma_{1,n+1} - \sigma_{3,n+1}}{\sigma_{1,n+1}^{\text{trial}} - \sigma_{3,n+1}^{\text{trial}}} & 0 \\ 0 & 0 & \frac{\sigma_{2,n+1} - \sigma_{3,n+1}}{\sigma_{2,n+1}^{\text{trial}} - \sigma_{3,n+1}^{\text{trial}}} \end{bmatrix} \quad (449)$$

Finally, the tangent matrix \mathbf{C} has to be transformed back into the global system yielding \mathbf{C}' :

$$\mathbf{C}' = \mathbf{A}^T \cdot \mathbf{C} \cdot \mathbf{A}, \quad (450)$$

where \mathbf{A} is the transformation matrix in equation (A5) in [19]. Notice that equation (A6) in [19] is wrong and has to be replaced by the equation above. Similarly the stress is to be transformed into the global system by:

$$\boldsymbol{\sigma}' = \mathbf{A}^T \cdot \boldsymbol{\sigma}. \quad (451)$$

6.8.12 Tension-only and compression-only materials.

These are material models which can be used to simulate textile behavior (tension-only) and concrete (compression-only). In essence, a one-dimensional Hooke-type relationship is established between the principal stresses and principal strains, thereby suppressing the compressive stress range (tension-only materials) or tensile stress range (compression-only materials).

The Cauchy-Green tensor can be written as a function of its eigenvalues and eigenvectors as follows:

$$\mathbf{C} = \sum_{i=1}^3 \Lambda_i \mathbf{M}^i, \quad (452)$$

where \mathbf{M}^i are the structural tensors satisfying $\mathbf{M}^i = \mathbf{N}_i \otimes \mathbf{N}^i$, \mathbf{N}^i being the principal directions [23]. From this, the second Piola-Kirchhoff stress tensor can be defined by:

$$\mathbf{S} = \sum_{i=1}^3 f(\Lambda_i) \mathbf{M}^i, \quad (453)$$

where, for tension-only materials,

$$f(\Lambda_i) = E \left(\frac{\Lambda_i - 1}{2} \right) \left[\frac{1}{2} + \frac{1}{\pi} \tan^{-1} \left(\frac{\Lambda_i - 1}{2\epsilon} \right) \right], \quad (454)$$

where E is an elastic modulus, the term within the first parentheses is a Lagrange principal strain and the term within the square brackets is a correction term suppressing the negative stresses (pressure). It is a function tending to zero for negative strains (-0.5 being the smallest possible Lagrange strain), to one for large positive strains and switches between both in a region surrounding zero strain. The extent of this region is controlled by the parameter ϵ : the smaller its value, the smaller the transition region (the sharper the switch). It is a monotonically increasing function of the strain, thus guaranteeing convergence. The correction term is in fact identical to the term used to cut off tensile stresses for penalty contact in Equation(226) and Figure (130). Replacing “overclosure” and “pressure” by “principal strain” and “principal stress” in that figure yields the function f . Although compressive stresses are suppressed, they are not zero altogether. The maximum allowed compressive stress (in absolute value)

amounts to $E\epsilon/\pi$. Instead of choosing E and ϵ the user defines E and the maximum allowed compressive stress, from which ϵ is determined.

The material definition consists of a *MATERIAL card defining the name of the material. This name HAS TO START WITH "TENSION_ONLY" but can be up to 80 characters long. Thus, the last 68 characters can be freely chosen by the user. Within the material definition a *USER MATERIAL card has to be used satisfying:

First line:

- *USER MATERIAL
- Enter the CONSTANTS parameter and its value. The value of this parameter is 2.

Following line:

- E .
- absolute value of the maximum allowed pressure.
- Temperature.

Repeat this line if needed to define complete temperature dependence.

For a compression-only materials the name of the material has to start with "COMPRESSION_ONLY" (maximum 64 characters left to be chosen by the user) and the second constant is the maximum allowed tension. Examples are leifer2 and concretebeam in the test example suite.

6.8.13 Fiber reinforced materials.

This is a model which was conceived by G. Holzapfel et al. [35] to model arterial walls. It is an anisotropic hyperelastic model, consisting of an isotropic neo-Hooke potential for the base material, complemented by exponential strengthening terms in fiber direction. The mathematical form of the potential satisfies:

$$U = C_{10}(\bar{I}_1 - 3) + \frac{1}{D_1}(J - 1)^2 + \sum_{i=1}^n \frac{k_{1i}}{2k_{2i}} \left[e^{k_{2i} \langle \bar{J}_{4i} - 1 \rangle^2} - 1 \right] \quad (455)$$

where $\langle x \rangle = 0$ for $x < 0$ and $\langle x \rangle = x$ for $x \geq 0$. Thus, the fibers do not take up any force under compression. Although the material was originally defined for arteries, it is expected to work well for other fiber reinforced materials too, such as reinforced nylon. The material model implemented thus far can cope with up to 4 different fibers. The material definition consists of a *MATERIAL card defining the name of the material. This name HAS TO START WITH "ELASTIC_FIBER" but can be up to 80 characters long. Thus, the last 67 characters can be freely chosen by the user. Within the material definition a *USER MATERIAL card has to be used satisfying:

First line:

- *USER MATERIAL
- Enter the CONSTANTS parameter and its value. The value of this parameter is $2+4n$, where n is the number of fiber directions.

Following line if one fiber direction is selected:

- C_{10} .
- D_1 .
- n_{x1} : x-direction cosine of fiber direction.
- n_{y1} : y-direction cosine of fiber direction.
- k_{11} .
- k_{21} .
- Temperature.

Repeat this line if needed to define complete temperature dependence. The z-direction cosine of the fiber direction is determined from the x- and y-direction cosine since the direction norm is one. If a local axis system is defined for an element consisting of this material (with *ORIENTATION) the direction cosines are defined in the local system.

If more than one fiber direction is selected (up to a maximum of four), the four entries characterizing fiber direction 1 are repeated for the subsequent directions. Per line no more than eight entries are allowed. If more are needed, continue on the next line.

Example:

```
*MATERIAL,NAME=ELASTIC_FIBER
*USER MATERIAL,CONSTANTS=18
1.92505,0.026,0.,0.7071,2.3632,0.8393,0,-0.7071,
2.3632,0.8393,0.7071,0.,2.3632,0.8393,-0.7071,0.,
2.3632,0.8393
```

defines an elastic fiber materials with four different fiber directions $(0,0.7071,0.7071)$, $(0,-0.7071,0.7071)$, $(0.7071,0.,0.7071)$ and $(-0.7071,0.,0.7071)$. The constants are $C_{10} = 1.92505$, $D_1 = 0.026$ and $k_{1i} = 2.3632$, $k_{2i} = 0.8393 \forall i \in \{1, 2, 3, 4\}$.

6.8.14 The Cailletaud single crystal model.

The single crystal model of Georges Cailletaud and co-workers [58][59] describes infinitesimal viscoplasticity in metallic components consisting of one single crystal. The orientations of the slip planes and slip directions in these planes is generally known and described by the normal vectors \mathbf{n}^β and direction vectors \mathbf{l}^β , respectively, where β denotes one of slip plane/slip direction combinations. The

slip planes and slip directions are reformulated in the form of a slip orientation tensor \mathbf{m}^β satisfying:

$$\mathbf{m}^\beta = (\mathbf{n}^\beta \otimes \mathbf{l}^\beta + \mathbf{l}^\beta \otimes \mathbf{n}^\beta)/2. \quad (456)$$

The total strain is supposed to be the sum of the elastic strain and the plastic strain:

$$\boldsymbol{\epsilon} = \boldsymbol{\epsilon}^e + \boldsymbol{\epsilon}^p. \quad (457)$$

In each slip plane an isotropic hardening variable q_1 and a kinematic hardening variable q_2 are introduced representing the isotropic and kinematic change of the yield surface, respectively. The yield surface for orientation β takes the form:

$$h^\beta := \left| \boldsymbol{\sigma} : \mathbf{m}^\beta + q_2^\beta \right| - r_0^\beta + \sum_{\alpha=1}^{n^\beta} H_{\beta\alpha} q_1^\alpha = 0 \quad (458)$$

where n^β is the number of slip orientations for the material at stake, $\boldsymbol{\sigma}$ is the stress tensor, r_0^β is the size of the elastic range at zero yield and $H_{\beta\alpha}$ is a matrix of interaction coefficients. The constitutive equations for the hardening variables satisfy:

$$q_1^\beta = -b^\beta Q^\beta \alpha_1^\beta \quad (459)$$

and

$$q_2^\beta = -c^\beta \alpha_2^\beta \quad (460)$$

where α_1^β and α_2^β are the hardening variables in strain space. The constitutive equation for the stress is Hooke's law:

$$\boldsymbol{\sigma} = \mathbf{C} : \boldsymbol{\epsilon}^e. \quad (461)$$

The evolution equations for the plastic strain and the hardening variables in strain space are given by:

$$\dot{\boldsymbol{\epsilon}}^p = \sum_{\beta=1}^{n^\beta} \dot{\gamma}^\beta \mathbf{m}^\beta \operatorname{sgn}(\boldsymbol{\sigma} : \mathbf{m}^\beta + q_2^\beta), \quad (462)$$

$$\dot{\alpha}_1^\beta = \dot{\gamma}^\beta \left(1 + \frac{q_1^\beta}{Q^\beta} \right) \quad (463)$$

and

$$\dot{\alpha}_2^\beta = \dot{\gamma}^\beta \left[\varphi^\beta \operatorname{sgn}(\boldsymbol{\sigma} : \mathbf{m}^\beta + q_2^\beta) + \frac{d^\beta q_2^\beta}{c^\beta} \right]. \quad (464)$$

The variable $\dot{\gamma}^\beta$ is the consistency coefficient known from the Kuhn-Tucker conditions in optimization theory [52]. It can be proven to satisfy:

$$\dot{\gamma}^\beta = \left| \dot{\epsilon}^{p^\beta} \right|, \quad (465)$$

where $\dot{\epsilon}^{p^\beta}$ is the flow rate along orientation β . The plastic strain rate is linked to the flow rate along the different orientations by

$$\dot{\epsilon}^p = \sum_{\beta=1}^{n^\beta} \dot{\epsilon}^{p^\beta} \mathbf{m}^\beta. \quad (466)$$

The parameter φ^β in equation (464) is a function of the accumulated shear flow in absolute value through:

$$\varphi^\beta = \phi^\beta + (1 - \phi^\beta) e^{-\delta^\beta \int_0^t \dot{\gamma}^\beta dt} \quad (467)$$

Finally, in the Cailletaud model the creep rate is a power law function of the yield exceedance:

$$\dot{\gamma}^\beta = \left\langle \frac{h^\beta}{K^\beta} \right\rangle^{n^\beta}. \quad (468)$$

The brackets $\langle \rangle$ reduce negative function values to zero while leaving positive values unchanged, i.e. $\langle x \rangle = 0$ if $x < 0$ and $\langle x \rangle = x$ if $x \geq 0$.

In the present umat routine, the Cailletaud model is implemented for a Nickel base single crystal. It has two slip systems, a octaeder slip system with three slip directions $\langle 011 \rangle$ in four slip planes $\{111\}$, and a cubic slip system with two slip directions $\langle 011 \rangle$ in three slip planes $\{001\}$. The constants for all octaeder slip orientations are assumed to be identical, the same applies for the cubic slip orientations. Furthermore, there are three elastic constants for this material. Consequently, for each temperature 21 constants need to be defined: the elastic constants C_{1111} , C_{1122} and C_{1212} , and a set $\{K^\beta, n^\beta, c^\beta, d^\beta, \phi^\beta, \delta^\beta, r_0^\beta, Q^\beta, b^\beta\}$ per slip system. Apart from these constants 18^2 interaction coefficients need to be defined. These are taken from the references [58][59] and assumed to be constant. Their values are included in the routine and cannot be influence by the user through the input deck.

The material definition consists of a *MATERIAL card defining the name of the material. This name HAS TO START WITH "SINGLE_CRYSTAL" but can be up to 80 characters long. Thus, the last 66 characters can be freely chosen by the user. Within the material definition a *USER MATERIAL card has to be used satisfying:

First line:

- *USER MATERIAL
- Enter the CONSTANTS parameter and its value, i.e. 21.

Following lines, in sets of 3:

First line of set:

- C_{1111} .
- C_{1122} .
- C_{1212} .
- K^β (octaeder slip system).
- n^β (octaeder slip system).
- c^β (octaeder slip system).
- d^β (octaeder slip system).
- ϕ^β (octaeder slip system).

Second line of set:

- δ^β (octaeder slip system).
- r_0^β (octaeder slip system).
- Q^β (octaeder slip system).
- b^β (octaeder slip system).
- K^β (cubic slip system).
- n^β (cubic slip system).
- c^β (cubic slip system).
- d^β (cubic slip system).

Third line of set:

- ϕ^β (cubic slip system).
- δ^β (cubic slip system).
- r_0^β (cubic slip system).
- Q^β (cubic slip system).
- b^β (cubic slip system).
- Temperature.

Repeat this set if needed to define complete temperature dependence.

The crystal principal axes are assumed to coincide with the global coordinate system. If this is not the case, use an *ORIENTATION card to define a local system.

For this model, there are 60 internal state variables:

- the plastic strain tensor ϵ^P (6)
- the isotropic hardening variables q_1^β (18)
- the kinematic hardening variables q_2^β (18)
- the accumulated absolute value of the slip rate $\int_0^t \dot{\gamma}^\beta dt$ (18)

These variables are accessible through the *EL PRINT (.dat file) and *EL FILE (.frd file) keywords in exactly this order (label SDV). The *DEPVAR card must be included in the material definition with a value of 60.

Example:

```
*MATERIAL,NAME=SINGLE_CRYSTAL
*USER MATERIAL,CONSTANTS=21
135468.,68655.,201207.,1550.,3.89,18.E4,1500.,1.5,
100.,80.,-80.,500.,980.,3.89,9.E4,1500.,
2.,100.,70.,-50.,400.
*DEPVAR
60
```

defines a single crystal with elastic constants {135468., 68655., 201207.}, octaeder parameters {1550., 3.89, 18.E4, 1500., 1.5, 100., 80., -80., 500.} and cubic parameters {980., 3.89, 9.E4, 1500., 2., 100., 70., -50.} for a temperature of 400.

6.8.15 The Cailletaud single crystal creep model.

This is the Cailletaud single crystal model reduced to the creep case, i.e. the yield surface is reduced to zero.

The material definition consists of a *MATERIAL card defining the name of the material. This name HAS TO START WITH "SINGLE_CRYSTAL_CREEP" but can be up to 80 characters long. Thus, the last 60 characters can be freely chosen by the user. Within the material definition a *USER MATERIAL card has to be used satisfying:

First line:

- *USER MATERIAL
- Enter the CONSTANTS parameter and its value, i.e. 7.

Following line:

- C_{1111} .
- C_{1122} .
- C_{1212} .
- K^β (octaeder slip system).
- n^β (octaeder slip system).
- K^β (cubic slip system).
- n^β (cubic slip system).
- Temperature.

Repeat this line if needed to define complete temperature dependence.

The crystal principal axes are assumed to coincide with the global coordinate system. If this is not the case, use an *ORIENTATION card to define a local system.

For this model, there are 24 internal state variables:

- the plastic strain tensor ϵ^P (6)
- the accumulated absolute value of the slip rate $\int_0^t \dot{\gamma}^\beta dt$ (18)

These variables are accessible through the *EL PRINT (.dat file) and *EL FILE (.frd file) keywords in exactly this order (label SDV). The *DEPVAR card must be included in the material definition with a value of 24.

Example:

```
*MATERIAL,NAME=SINGLE_CRYSTAL
*USER MATERIAL,CONSTANTS=21
135468.,68655.,201207.,1550.,3.89,980.,3.89,400.
*DEPVAR
24
```

defines a single crystal with elastic constants {135468., 68655., 201207.}, octaeder parameters {1550., 3.89} and cubic parameters {980., 3.89} for a temperature of 400.

6.8.16 Elastic anisotropy with isotropic viscoplasticity.

This model describes small deformations for elastically anisotropic materials with a von Mises type yield surface. Often, this model is used as a compromise for anisotropic materials with lack of data or detailed knowledge about the anisotropic behavior in the viscoplastic range.

The total strain is supposed to be the sum of the elastic strain and the plastic strain:

$$\boldsymbol{\epsilon} = \boldsymbol{\epsilon}^e + \boldsymbol{\epsilon}^p. \quad (469)$$

An isotropic hardening variable q_1 and a kinematic hardening tensor \mathbf{q}_2 are introduced representing the isotropic and kinematic change of the yield surface, respectively. The yield surface takes the form:

$$f := \|\mathbf{dev}(\boldsymbol{\sigma}) + \mathbf{q}_2\| + \sqrt{\frac{2}{3}}(q_1 - r_0) = 0 \quad (470)$$

where $\mathbf{dev}(\boldsymbol{\sigma})$ is the deviatoric stress tensor, and r_0 is the size of the elastic range at zero yield. The constitutive equations for the hardening variables satisfy:

$$q_1 = -d_1 \alpha_1 \quad (471)$$

and

$$\mathbf{q}_2 = -\frac{2}{3}d_2 \boldsymbol{\alpha}_2 \quad (472)$$

where α_1 and $\boldsymbol{\alpha}_2$ are the hardening variables in strain space. It can be shown that

$$\alpha_1 = \epsilon^{peq}, \quad (473)$$

$$\alpha_2^{eq} = \epsilon^{peq}, \quad (474)$$

where ϵ^{peq} is the equivalent plastic strain defined by

$$\epsilon^{peq} = \sqrt{\frac{2}{3}} \|\boldsymbol{\epsilon}^p\|. \quad (475)$$

and α_2^{eq} is the equivalent value of the tensor $\boldsymbol{\alpha}_2$ defined in a similar way. Thus, the constitutive equations amount to

$$q_1 = -d_1 \epsilon^{peq} \quad (476)$$

and

$$q_2^{eq} = d_2 \epsilon^{peq}, \quad (477)$$

where

$$q_2^{eq} = \sqrt{\frac{3}{2}} \|\mathbf{q}_2\| \quad (478)$$

has the meaning of an equivalent stress value or von Mises value. The same applies to q_1 . Consequently, the constitutive equations assume a linear relationship between the hardening stress and the equivalent plastic strain.

The constitutive equation for the stress is Hooke's law:

$$\boldsymbol{\sigma} = \mathbf{C} : \boldsymbol{\epsilon}^e. \quad (479)$$

The evolution equations for the plastic strain and the hardening variables in strain space are given by:

$$\dot{\boldsymbol{\epsilon}}^p = \dot{\gamma} \mathbf{n}, \quad (480)$$

$$\dot{\alpha}_1 = \sqrt{\frac{2}{3}} \dot{\gamma}, \quad (481)$$

and

$$\dot{\alpha}_2 = \dot{\gamma} \mathbf{n}, \quad (482)$$

where

$$\mathbf{n} = \frac{\mathit{dev}(\boldsymbol{\sigma}) + \mathbf{q}_2}{\|\mathit{dev}(\boldsymbol{\sigma}) + \mathbf{q}_2\|}. \quad (483)$$

The variable $\dot{\gamma}$ is the consistency coefficient known from the Kuhn-Tucker conditions in optimization theory [52]. It can be proven to satisfy:

$$\dot{\gamma} = \sqrt{\frac{3}{2}} \dot{\epsilon}^{peq}, \quad (484)$$

Finally, the creep rate is modeled as a power law function of the yield exceedance and total time t :

$$\dot{\epsilon}^{peq} = A \left\langle \sqrt{\frac{3}{2}} f \right\rangle^n t^m. \quad (485)$$

The brackets $\langle \rangle$ reduce negative function values to zero while leaving positive values unchanged, i.e. $\langle x \rangle = 0$ if $x < 0$ and $\langle x \rangle = x$ if $x \geq 0$.

In the present implementation orthotropic elastic behavior is assumed. Consequently, for each temperature 15 constants need to be defined: the elastic constants C_{1111} , C_{1122} , C_{2222} , C_{1133} , C_{2233} , C_{3333} , C_{1212} , C_{1313} , C_{2323} , and the viscoplastic constants r_0 , d_1 , d_2 , A , n , m .

The material definition consists of a *MATERIAL card defining the name of the material. This name HAS TO START WITH "ANISO_PLAS" but can be up to 80 characters long. Thus, the last 70 characters can be freely chosen by the user. Within the material definition a *USER MATERIAL card has to be used satisfying:

First line:

- *USER MATERIAL
- Enter the CONSTANTS parameter and its value, i.e. 15.

Following lines, in sets of 2:

First line of set:

- C_{1111} .
- C_{1122} .
- C_{2222} .
- C_{1133} .
- C_{2233} .
- C_{3333} .
- C_{1212} .
- C_{1313} .

Second line of set:

- C_{2323} .
- r_0 .
- d_1 .
- d_2 .
- A .
- n .
- m .
- Temperature.

Repeat this set if needed to define complete temperature dependence.

The principal axes of the material are assumed to coincide with the global coordinate system. If this is not the case, use an *ORIENTATION card to define a local system.

For this model, there are 14 internal state variables:

- the equivalent plastic strain ϵ^{peq} (1)
- the plastic strain tensor ϵ^P (6)
- the isotropic hardening variable α_1 (1)
- the kinematic hardening tensor α_2 (6)

These variables are accessible through the *EL PRINT (.dat file) and *EL FILE (.frd file) keywords in exactly this order (label SDV). The *DEPVAR card must be included in the material definition with a value of 14.

Example:

```
*MATERIAL,NAME=ANISO_PLAS
*USER MATERIAL,CONSTANTS=15
500000.,157200.,500000.,157200.,157200.,500000.,126200.,126200.,
126200.,0.,0.,0.,1.E-10,5,0.
*DEPVAR
14
```

defines a single crystal with elastic constants 500000., 157200., 500000., 157200., 157200., 500000., 126200., 126200., 126200., and viscoplastic parameters $r_0 = 0.$, $d_1 = 0.$, $d_2 = 0.$, $A = 10^{-10}$, $n = 5$ and $m = 0$. Thus, the yield surface has a zero radius and there is no hardening. Only creep is activated.

6.8.17 Elastic anisotropy with user defined isotropic creep.

This material model is similar to the previous one, except that

- no plasticity is assumed (yield surface coincides with the origine)
- the creep model is to be provided by a creep user subroutine

In the present implementation orthotropic elastic behavior is assumed. Consequently, for each temperature 9 constants need to be defined: the elastic constants C_{1111} , C_{1122} , C_{2222} , C_{1133} , C_{2233} , C_{3333} , C_{1212} , C_{1313} and C_{2323} .

The material definition consists of a *MATERIAL card defining the name of the material. This name HAS TO START WITH "ANISO_CREEP" but can be up to 80 characters long. Thus, the last 69 characters can be freely chosen by the user. Within the material definition a *USER MATERIAL card has to be used satisfying:

First line:

- *USER MATERIAL
- Enter the CONSTANTS parameter and its value, i.e. 9.

Following lines, in sets of 2:

First line of set:

- C_{1111} .
- C_{1122} .
- C_{2222} .
- C_{1133} .
- C_{2233} .

- C_{3333} .
- C_{1212} .
- C_{1313} .

Second line of set:

- C_{2323} .
- Temperature.

Repeat this set if needed to define complete temperature dependence.

The principal axes of the material are assumed to coincide with the global coordinate system. If this is not the case, use an *ORIENTATION card to define a local system.

For this model, there are 7 internal state variables (recall that CalculiX does not make a distinction between plastic strain and creep strain: the field ϵ^p contains the sum of both):

- the equivalent plastic strain ϵ^{peq} (1)
- the plastic strain tensor ϵ^p (6)

These variables are accessible through the *EL PRINT (.dat file) and *EL FILE (.frd file) keywords in exactly this order (label SDV). The *DEPVAR card must be included in the material definition with a value of 7.

The creep subroutine has to be provided by the user (cf. Section 8.1). Since the material is anisotropic the input to the creep routine is the equivalent deviatoric creep strain, the output is the von Mises stress and the derivative of the equivalent deviatoric creep strain increment w.r.t. the von Mises stress.

Example:

```
*MATERIAL,NAME=ANISO_CREEP
*USER MATERIAL,CONSTANTS=9
500000.,157200.,500000.,157200.,157200.,500000.,126200.,126200.,
126200.
*DEPVAR
7
```

defines a single crystal with elastic constants 500000., 157200., 500000., 157200., 157200., 500000., 126200., 126200. and 126200.. The creep law has to be provide by the user in the form of a creep.f subroutine.

6.8.18 User materials

Other material laws can be defined by the user by means of the *USER MATERIAL keyword card. More information and examples can be found in section 8.5.

A user material card requires the coding of a user material subroutine, either of the CalculiX type or the Abaqus type.

For a user material routine of the CalculiX type the routine `umat_user.f` can be taken as example. The input primarily exists of the mechanical Lagrange strain tensor at the beginning and end of the increment, requested output is the Piola-Kirchhoff stress tensor of the second kind and the derivative of the Piola-Kirchhoff stress of the second kind with respect to the mechanical Lagrange strain tensor, both at the end of the increment. Details of other input fields is given in the section referenced above.

For a user material routine of the Abaqus type there are two possibilities: either the user wants to apply the routine to linear geometric calculations only. Then, the kind of strain and stress going in or out of the routine is not important and the previous paragraph applies. However, if the user would like to apply the routine to geometrically nonlinear calculations, the strain entering the routine is the corotational mechanical logarithmic strain and the required stress is the corotational Cauchy stress. So CalculiX has to perform some conversions before and after calling the Abaqus user material routine. For a prototype example of a Abaqus user material routine the user is referred to `umat.f`, for limitations on the use of the Abaqus interface fields section 8.5 should be consulted.

Here, some information is given on how the fields used in CalculiX (mechanical Lagrange strain and Piola-Kirchhoff stress of the second kind) are converted into the fields required by Abaqus (corotational mechanical logarithmic strain and corotational Cauchy stress) and vice versa. The conversions is coded in `umat_abaqusnl.f`.

The mechanical logarithmic strain satisfies

$$e_{\text{ln}}^{\mathcal{M}} = \sum_i \lambda_i^{\mathcal{M}} \mathbf{n}_i \otimes \mathbf{n}_i, \quad (486)$$

where $\lambda_i^{\mathcal{M}}$ are the eigenvalues of the mechanical deformation gradient $\mathbf{F}^{\mathcal{M}}$. In calculiX, the mechanical deformation gradient is obtained by subtracting the thermal expansion from the total deformation gradient, i.e.

$$\mathbf{F}^{\mathcal{M}} = \mathbf{F} - \alpha \Delta T \mathbf{I} \quad (487)$$

for isotropic expansion. The rotation tensor $\mathbf{R} = \mathbf{n}_i \otimes \mathbf{N}_i$ rotates the principal vectors \mathbf{N}_i of the motion in material coordinates in spatial coordinates \mathbf{n}_i :

$$\mathbf{n}_i = \mathbf{R} \cdot \mathbf{N}_i. \quad (488)$$

It is a two-point tensor with one leg in the material frame of reference and one leg in the spatial frame of reference. The corotational mechanical logarithmic strain then amounts to (recall that \mathbf{R} is orthogonal, i.e. $\mathbf{R}^{-1} = \mathbf{R}^T$):

$$\hat{e}_{\text{ln}}^{\mathcal{M}} = \mathbf{R}^T \cdot e_{\text{ln}}^{\mathcal{M}} \cdot \mathbf{R} = \sum_i \lambda_i^{\mathcal{M}} \mathbf{N}_i \otimes \mathbf{N}_i. \quad (489)$$

$\lambda_i^{\mathcal{M}}$ can be obtained from the eigenvalues of the mechanical Lagrange tensor $\mathbf{E}^{\mathcal{M}} = (\mathbf{F}^{\mathcal{M},T} \cdot \mathbf{F}^{\mathcal{M}} - \mathbf{I})/2$ and its eigenvectors are \mathbf{N}_i .

The Cauchy tensor satisfies

$$\boldsymbol{\sigma} = J^{-1} \mathbf{R} \cdot \mathbf{U} \cdot \mathbf{S} \cdot \mathbf{U}^T \cdot \mathbf{R}^T, \quad (490)$$

and consequently the corotational Cauchy tensor amounts to

$$\hat{\boldsymbol{\sigma}} = \mathbf{R}^T \cdot \boldsymbol{\sigma} \cdot \mathbf{R} = J^{-1} \mathbf{U} \cdot \mathbf{S} \cdot \mathbf{U}^T. \quad (491)$$

Here, J is the Jacobian determinant, \mathbf{S} is the Piola-Kirchhoff stress of the second kind and \mathbf{U} is the right-stretch tensor. The latter is the square root of the Cauchy-Green tensor \mathbf{C} and therefore it can also be derived from the Lagrange tensor. However, in routine umat_abaqusnl.f the mechanical Lagrange tensor is available and not the total one. So a relationship is needed between the total right-stretch tensor and the mechanical right-stretch tensor. Since \mathbf{U} has the same eigenvalues as \mathbf{F} and the multiplicative decomposition of the deformation gradient in a mechanical and thermal deformation gradient leads to $\lambda = \lambda^{\mathcal{M}}(1 + \alpha\Delta T)$ one obtains:

$$\hat{\boldsymbol{\sigma}} = J^{-1} \mathbf{U}^{\mathcal{M}} \cdot \mathbf{S} \cdot (\mathbf{U}^{\mathcal{M}})^T (1 + \alpha\Delta T)^2. \quad (492)$$

The latter equation assumes that the thermal expansion is isotropic. In routine umat_abaqusnl.f \mathbf{S} is known, $\mathbf{U}^{\mathcal{M}}$ can be obtained from $\mathbf{E}^{\mathcal{M}}$ and $(1 + \alpha\Delta T)$ results from

$$(1 + \alpha\Delta T) = \sqrt{\frac{(\mathbf{F}^T \cdot \mathbf{F})_{11}}{2\mathbf{E}_{11}^{\mathcal{M}} + 1}}, \quad (493)$$

where the index $_{11}$ refers to element (1,1) of the corresponding matrix. In this way the corotational Cauchy stress is obtained from the Piola-Kirchhoff stress of the second kind. The inverse relationship is used after returning from the Abaqus material user subroutine:

$$\mathbf{S} = J\mathbf{U}^{-1} \cdot \hat{\boldsymbol{\sigma}} \cdot \mathbf{U}^{-T}. \quad (494)$$

Now, $\partial\mathbf{S}/\partial\mathbf{E}^{\mathcal{M}}$ is needed in CalculiX (i.e. total Lagrangian approach), however, the Abaqus routine returns $\partial\hat{\boldsymbol{\sigma}}/\partial\hat{\mathbf{e}}_{\text{ln}}^{\mathcal{M}}$. Performing an exact transformation is very tedious and nearly impossible. It would require an enormous computational effort and frequently results in an asymmetric $\partial\mathbf{S}/\partial\mathbf{E}^{\mathcal{M}}$ - matrix even if $\partial\hat{\boldsymbol{\sigma}}/\partial\hat{\mathbf{e}}_{\text{ln}}^{\mathcal{M}}$ is symmetric. To avoid longer computational times due to the use of an asymmetric linear equation solver a symmetrization is usually performed leading to an approximation anyway. Therefore, a simplified approach is taken which reduced the computational effort to a minimum while leading to acceptable convergence rates despite the approximations involved.

From the relationship between \mathbf{S} and $\hat{\boldsymbol{\sigma}}$ one obtains (in Cartesian coordinates)

$$\left(\frac{\partial \mathbf{S}_{IJ}}{\partial \mathbf{E}_{KL}^{\mathcal{M}}} \right) \approx J \mathbf{U}_{IM}^{-1} \left(\frac{\partial \hat{\sigma}_{MN}}{\partial \mathbf{E}_{KL}^{\mathcal{M}}} \right) \mathbf{U}_{NJ}^{-1} \quad (495)$$

(recall that \mathbf{U} is symmetric). In the above equation the dependence of \mathbf{U}^{-1} on $\mathbf{E}^{\mathcal{M}}$ has been neglected (first approximation). One can further write:

$$\left(\frac{\partial \mathbf{S}_{IJ}}{\partial \mathbf{E}_{KL}^{\mathcal{M}}} \right) \approx J \mathbf{U}_{IM}^{-1} \left(\frac{\partial \hat{\sigma}_{MN}}{\partial \hat{\mathbf{e}}_{\text{ln},PQ}^{\mathcal{M}}} \right) \left(\frac{\partial \hat{\mathbf{e}}_{\text{ln},PQ}^{\mathcal{M}}}{\partial \mathbf{E}_{KL}^{\mathcal{M}}} \right) \mathbf{U}_{NJ}^{-1} \quad (496)$$

or, approximating the corotational mechanical logarithmic strain $\hat{\mathbf{e}}_{\text{ln}}^{\mathcal{M}}$ by the corotational mechanical Eulerian strain $\hat{\mathbf{e}}^{\mathcal{M}}$ (second approximation):

$$\left(\frac{\partial \mathbf{S}_{IJ}}{\partial \mathbf{E}_{KL}^{\mathcal{M}}} \right) \approx J \mathbf{U}_{IM}^{-1} \left(\frac{\partial \hat{\sigma}_{MN}}{\partial \hat{\mathbf{e}}_{\text{ln},PQ}^{\mathcal{M}}} \right) \left(\frac{\partial \hat{\mathbf{e}}_{PQ}^{\mathcal{M}}}{\partial \mathbf{E}_{KL}^{\mathcal{M}}} \right) \mathbf{U}_{NJ}^{-1}. \quad (497)$$

The Eulerian strain satisfies:

$$2\mathbf{e} = \mathbf{F}^{-T} \cdot 2\mathbf{E} \cdot \mathbf{F}^{-1}. \quad (498)$$

which amounts to:

$$\left(\mathbf{I} - \frac{\mathbf{F}^{\mathcal{M}-T} \cdot \mathbf{F}^{\mathcal{M}-1}}{(1 + \alpha \Delta T)^2} \right) = \mathbf{F}^{-T} \cdot \left(\mathbf{F}^{\mathcal{M}T} \cdot \mathbf{F}^{\mathcal{M}} (1 + \alpha \Delta T)^2 - \mathbf{I} \right) \cdot \mathbf{F}^{-1}. \quad (499)$$

This can be written as:

$$\begin{aligned} \mathbf{I} &= \mathbf{F}^{\mathcal{M}-T} \cdot \mathbf{F}^{\mathcal{M}-1} + 2\xi \mathbf{I} \\ &= \mathbf{F}^{-T} \cdot \left(\mathbf{F}^{\mathcal{M}T} \cdot \mathbf{F}^{\mathcal{M}} - \mathbf{I} + 2\xi \mathbf{F}^{\mathcal{M}T} \cdot \mathbf{F}^{\mathcal{M}} \right) \cdot \mathbf{F}^{-1} (1 + \alpha \Delta T)^2, \end{aligned} \quad (500)$$

where

$$2\xi := 2\alpha \Delta T + \alpha^2 (\Delta T)^2. \quad (501)$$

This leads to:

$$\mathbf{e}^{\mathcal{M}} + \xi \mathbf{I} = \mathbf{F}^{\mathcal{M}-T} \cdot (\mathbf{E}^{\mathcal{M}} + \xi \mathbf{C}^{\mathcal{M}}) \cdot \mathbf{F}^{\mathcal{M}-1}, \quad (502)$$

or

$$\mathbf{e}^{\mathcal{M}} = \mathbf{F}^{\mathcal{M}-T} \cdot \mathbf{E}^{\mathcal{M}} \cdot \mathbf{F}^{\mathcal{M}-1}. \quad (503)$$

Consequently, the corotational mechanical Eulerian strain amounts to:

$$\hat{\mathbf{e}}_{PQ}^{\mathcal{M}} = \mathbf{R}_{PR}^T \mathbf{e}_{RS}^{\mathcal{M}} \mathbf{R}_{SQ} = \mathbf{U}_{PR}^{\mathcal{M}-1} \mathbf{E}_{RS}^{\mathcal{M}} \mathbf{U}_{SQ}^{\mathcal{M}-1}, \quad (504)$$

leading to (again using the first approximation for the inverse mechanical right-stretch tensor)

$$\left(\frac{\partial \hat{\mathbf{e}}_{PQ}^{\mathcal{M}}}{\partial \mathbf{E}_{KL}^{\mathcal{M}}} \right) \approx \mathbf{U}^{\mathcal{M}^{-1}}{}_{PR} (\mathbb{I}_I)_{RSKL} \mathbf{U}^{\mathcal{M}^{-1}}{}_{SQ}, \quad (505)$$

where

$$(\mathbb{I}_I)_{RSKL} := (\delta_{RK}\delta_{SL} + \delta_{RL}\delta_{SK})/2. \quad (506)$$

Due to the symmetry of the corotational mechanical Eulerian strain tensor and the symmetry of the inverse right-stretch tensor, one can write after substitution of Equation (506) into Equation (505):

$$\left(\frac{\partial \hat{\sigma}_{MN}}{\partial \hat{\mathbf{e}}_{\text{ln},PQ}^{\mathcal{M}}} \right) \mathbf{U}^{-\mathcal{M}^{-1}}{}_{PR} (\mathbb{I}_I)_{RSKL} \mathbf{U}^{\mathcal{M}^{-1}}{}_{SQ} = \left(\frac{\partial \hat{\sigma}_{MN}}{\partial \hat{\mathbf{e}}_{\text{ln},PQ}^{\mathcal{M}}} \right) \mathbf{U}^{\mathcal{M}^{-1}}{}_{PK} \mathbf{U}^{\mathcal{M}^{-1}}{}_{QL}. \quad (507)$$

One finally obtains:

$$\left(\frac{\partial \mathbf{S}_{IJ}}{\partial \mathbf{E}_{KL}^{\mathcal{M}}} \right) \approx J \left(\frac{\partial \hat{\sigma}_{MN}}{\partial \hat{\mathbf{e}}_{\text{ln},PQ}^{\mathcal{M}}} \right) \mathbf{U}_{IM}^{-1} \mathbf{U}_{JN}^{-1} \mathbf{U}^{\mathcal{M}^{-1}}{}_{KP} \mathbf{U}^{\mathcal{M}^{-1}}{}_{LQ}. \quad (508)$$

This is the expression which is used for the material tangent. The approximations do not lead to a false result, they just slow down the convergence. Since the wish to avoid asymmetric matrices precludes quadratic convergence anyway the above approximations seem tolerable. This has been confirmed in practical numerical simulations of e.g. the deformation plasticity model and the Johnson-Cook model in implicit dynamic calculations (in explicit dynamic calculations the material tangent is not needed).

6.9 Types of analysis

An analysis type applies to a complete step, which starts with a *STEP card and ends with an *END STEP card. The analysis type, the loading and field output requests must be defined in between.

6.9.1 Static analysis

In a static analysis the time dimension is not involved. The loading is assumed to be applied in a quasi-static way, i.e. so slow that inertia effects can be neglected. A static analysis is defined by the key word *STATIC. A static step can be geometrically linear or nonlinear. In both cases a Lagrangian point of view is taken and all variables are specified in the material frame of reference [25]. Thus, the stress used internally in CalculiX is the second Piola-Kirchhoff tensor acting on the undeformed surfaces.

For geometrically linear calculations the infinitesimal strains are taken (linearized version of the Lagrangian strain tensor), and the loads do not interfere

with each other. Thus, the deformation due to two different loads is the sum of the deformation due to each of them. For linear calculations the difference between the Cauchy and Piola-Kirchhoff stresses is negligible.

For geometrically nonlinear calculations, the full Lagrangian strain tensor is used. A geometrically nonlinear calculation is triggered by the parameter NL-GEOM on the *STEP card. The step is usually divided into increments, and the user is supposed to provide an initial increment length and the total step length on the *STATIC card. The increment length can be fixed (parameter DIRECT on the *STATIC card) or automatic. In case of automatic incrementation, the increment length is automatically adjusted according to the convergence characteristics of the problem. In each increment, the program iterates till convergence is reached, or a new attempt is made with a smaller increment size. In each iteration the geometrically linear stiffness matrix is augmented with an initial displacement stiffness due to the deformation in the last iteration and with an initial stress stiffness due to the last iteration's stresses [109]. For the output on file the second Piola-Kirchhoff stress is converted into the Cauchy or true stress, since this is the stress which is really acting on the structure.

Special provisions are made for cyclic symmetric structures. A cyclic symmetric structure is characterized by N identical sectors, see Figure 144 and the discussion in next section. Static calculations for such structures under cyclic symmetric loading lead to cyclic symmetric displacements. Such calculations can be reduced to the consideration of just one sector, the so-called datum sector, subject to cyclic symmetry conditions, i.e. the right boundary of the sector exhibits the same displacements as the left boundary, in cylindrical coordinates (NOT in rectangular coordinates!). The application of these boundary conditions is greatly simplified by the use of the keyword cards *SURFACE, *TIE and *CYCLIC SYMMETRY MODEL, defining the nodes on left and right boundary and the sector size. Then, the appropriate multiple point constraints are generated automatically. This can also be used for a static preload step prior to a perturbative frequency analysis.

6.9.2 Frequency analysis

In a frequency analysis the lowest eigenfrequencies and eigenmodes of the structure are calculated. In CalculiX, the mass matrix is not lumped, and thus a generalized eigenvalue problem has to be solved. The theory can be found in any textbook on vibrations or on finite elements, e.g. [109]. A crucial point in the present implementation is that, instead of looking for the smallest eigenfrequencies of the generalized eigenvalue problem, the largest eigenvalues of the inverse problem are determined. For large problems this results in execution times cut by about a factor of 100 (!). The inversion is performed by calling the linear equation solver SPOOLES. A frequency step is triggered by the keyword *FREQUENCY and can be perturbative or not.

If the perturbation parameter is not activated on the *STEP card, the frequency analysis is performed on the unloaded structure, constrained by the homogeneous SPC's and MPC's. Any steps preceding the frequency step do

not have any influence on the results.

If the perturbation parameter is activated, the stiffness matrix is augmented by contributions resulting from the displacements and stresses at the end of the last non-perturbative static step, if any, and the material parameters are based on the temperature at the end of that step. Thus, the effect of the centrifugal force on the frequencies in a turbine blade can be analyzed by first performing a static calculation with these loads, and selecting the perturbation parameter on the *STEP card in the subsequent frequency step. The loading at the end of a perturbation step is reset to zero.

If the input deck is stored in the file “problem.inp”, where “problem” stands for any name, the eigenfrequencies are stored in the “problem.dat” file (notice that the format of the storage depends on the symmetry of the stiffness matrix; a nonsymmetric stiffness matrix results e.g. from contact friction and can lead to complex eigenvalues). Furthermore, if the parameter STORAGE is set to yes (STORAGE=YES) on the *FREQUENCY card the eigenfrequencies, eigenmodes, stiffness matrix and mass matrix are stored in binary form in a “problem.eig” file for further use (e.g. in a linear dynamic step).

All output of the eigenmodes is normalized by means of the mass matrix, i.e. the generalized mass is one. The eigenvalue of the generalized eigenvalue problem is actually the square of the eigenfrequency. The eigenvalue is guaranteed to be real (the stiffness and mass matrices are symmetric; the only exception to this is if contact friction is included, which can lead to complex eigenfrequencies), but it is positive only for positive definite stiffness matrices. Due to preloading the stiffness matrix is not necessarily positive definite. This can lead to purely imaginary eigenfrequencies which physically mean that the structure buckles.

Apart from the eigenfrequencies the total effective mass and total effective modal mass for all rigid body modes are also calculated and stored in the .dat-file. There are six rigid body modes, three translations and three rotations. Let us call any of these $\{R\}$. It is a vector corresponding to a unit rigid body mode, e.g. a unit translation in the global x-direction. The participation factors P_i are calculated by

$$P_i = \{U_i\}^T [M] \{R\}. \quad (509)$$

They reflect the degree of participation of each mode in the selected rigid body motion. Recall that the modes are mass-normalized, consequently the unit of the mode is $1/\sqrt{\text{mass}}$, the unit of the rigid body motion is length. The effective modal mass is defined by P_i^2 , the total effective modal mass by

$$\sum_i P_i^2 \quad (510)$$

(unit: mass · length²). The total effective mass is the size of the rigid motion, i.e. it is the internal product of the rigid motion with itself:

$$\{R\}^T [M] \{R\}. \quad (511)$$

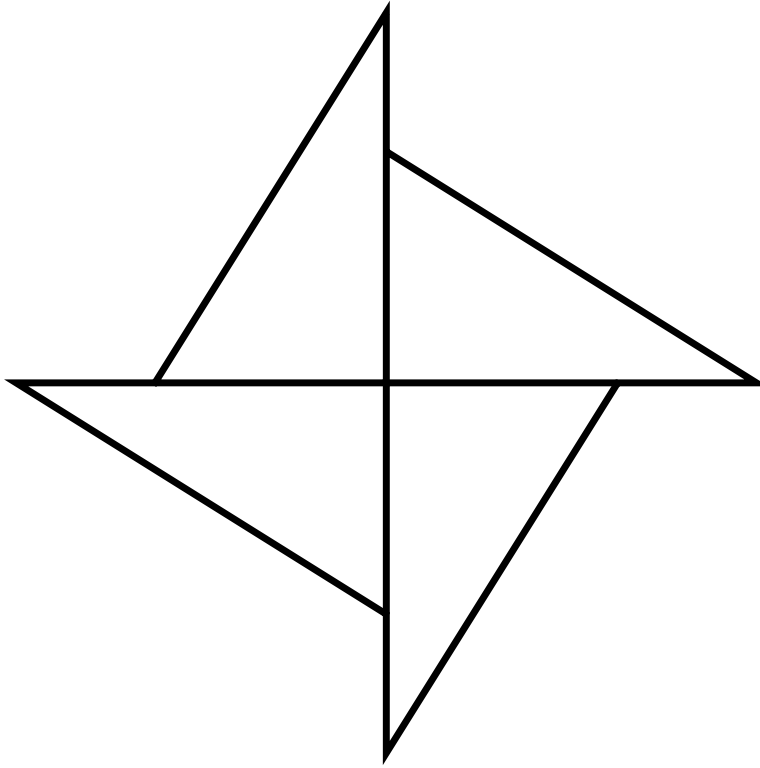

Figure 144: Cyclic symmetry structure consisting of four identical sectors

If one would calculate infinitely many modes the total effective modal mass should be equal to the total effective mass. Since only a finite number of modes are calculated the total effective modal mass will be less. By comparing the total effective modal mass with the total effective mass one gains an impression whether enough modes were calculated to perform good modal dynamics calculation (at least for the rigid motions).

A special kind of frequency calculations is a cyclic symmetry calculation for which the keyword cards `*SURFACE`, `*TIE`, `*CYCLIC SYMMETRY MODEL` and `*SELECT CYCLIC SYMMETRY MODES` are available. This kind of calculation applies to structures consisting of identical sectors ordered in a cyclic way such as in Figure 144.

For such structures it is sufficient to model just one sector (also called datum sector) to obtain the eigenfrequencies and eigenmodes of the whole structure. The displacement values on the left and right boundary (or surfaces) of the datum sector are phase shifted. The shift depends on how many waves are looked for along the circumference of the structure. Figure 145 shows an eigenmode for a full disk exhibiting two complete waves along the circumference. This corresponds to four zero-crossings of the waves and a nodal diameter of two. This

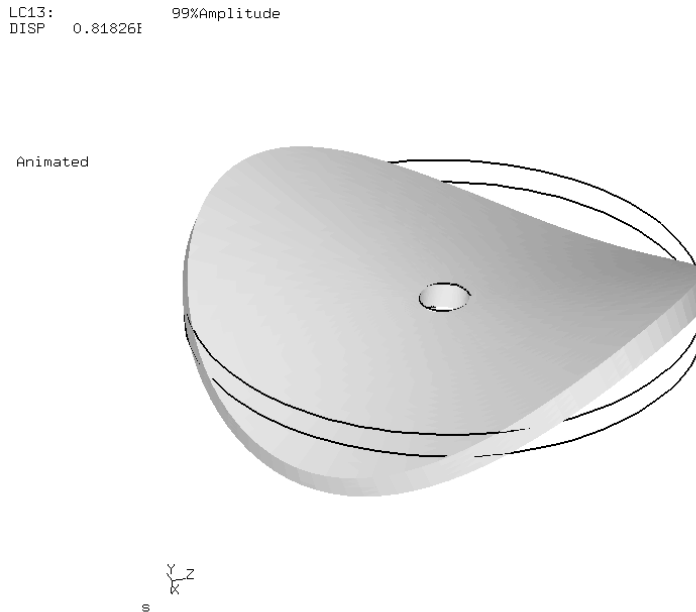

Figure 145: Eigenmode for a full disk with a nodal diameter of two

nodal diameter (also called cyclic symmetry mode number) can be considered as the number of waves, or also as the number of diameters in the structure along which the displacements are zero.

The lowest nodal diameter is zero and corresponds to a solution which is identical on the left and right boundary of the datum sector. For a structure consisting of N sectors, the highest feasible nodal diameter is $N/2$ for N even and $(N-1)/2$ for N odd. The nodal diameter is selected by the user on the *SELECT CYCLIC SYMMETRY MODES card. On the *CYCLIC SYMMETRY MODEL card, the number of base sectors fitting in 360° is to be provided. On the same card the user also indicates the number of sectors for which the solution is to be stored in the .frd file. In this way, the solution can be plotted for the whole structure, although the calculation was done for only one sector. The rotational direction for the multiplication of the datum sector is from the dependent surface (slave) to the independent surface (master).

Mathematically the left and right boundary of the datum sector are coupled by MPC's with complex coefficients. This leads to a complex generalized eigenvalue problem with a Hermitian stiffness matrix, which can be reduced to a real eigenvalue problem the matrices of which are twice the size as those in the original problem.

The phase shift between left and right boundary of the datum sector is given by $2\pi N/M$, where N is the nodal diameter and M is the number of base sectors

in 360° . Whereas N has to be an integer, CalculiX allows M to be a real number. In this way the user may enter a fictitious value for M , leading to arbitrary phase shifts between the left and right boundary of the datum sector (for advanced applications).

For models containing the axis of cyclic symmetry (e.g. a full disk), the nodes on the symmetry axis are treated differently depending on whether the nodal diameter is 0, 1 or exceeds 1. For nodal diameter 0, these nodes are fixed in a plane perpendicular to the cyclic symmetry axis, for nodal diameter 1 they cannot move along the cyclic symmetry axis and for higher nodal diameters they cannot move at all. For this kind of structures calculations for nodal diameters 0 or 1 must be performed in separate steps.

The mass normalization of a sector subject to cyclic symmetry is done based on the mass of the sector itself. If the normalization were done based on 360° the modes corresponding to a nodal diameter of 0 and $M/2$ (if M is even) would have to be divided by \sqrt{M} , the others by $\sqrt{M/2}$.

Adjacent structures with datum sectors which differ in size can be calculated by tying them together with the `*TIE,MULTISTAGE` keyword. This works well if the size difference of the datum sectors is not too large. This is illustrated by file `multistage.inp` in the test examples.

Eigenmodes resulting from frequency calculations with cyclic symmetry can be interpreted as traveling waves (indeed, all eigenmode solutions exhibiting a complex nature, i.e. containing a real and imaginary part, are traveling waves). Therefore, a circumferential traveling direction can be determined. This traveling direction is determined in CalculiX and stored in the `.dat`-file together with the axis reference direction.

To determine the traveling direction (cw or ccw) the displacement solution at the center of each element is calculated:

$$\begin{aligned} u &= u_R + iu_I \\ v &= v_R + iv_I \\ w &= w_R + iw_I, \end{aligned} \tag{512}$$

where u, v and w are the displacement components, the subscript R denotes the real part, I the imaginary part. The sum of the square amounts to

$$u^2 + v^2 + w^2 = (u_R^2 + v_R^2 + w_R^2 - u_I^2 - v_I^2 - w_I^2) + 2i(u_R u_I + v_R v_I + w_R w_I) \tag{513}$$

or

$$u^2 + v^2 + w^2 = A(r, \varphi, z) e^{i\psi(r, \varphi, z)}. \tag{514}$$

In the latter equation A is the amplitude, ψ the phase angle, both of which depend on the actual location, here described by the cylindrical coordinates r , φ and z . The motion of $u^2 + v^2 + w^2$ is now focussed on in order to determine the

traveling direction of the eigenmodes. Taking the frequency of the eigenmode into account one arrives at:

$$(u^2 + v^2 + w^2)e^{2i\omega t} = A(r, \varphi, z)e^{i(2\omega t + \psi(r, \varphi, z))}. \quad (515)$$

From this expression the wave character of the response is obvious. For an observer traveling around the axis (at constant r and z) with the local wave velocity one has:

$$2\omega t + \psi(r, \varphi, z) = \text{constant} \quad (516)$$

or

$$\frac{\partial \psi}{\partial \varphi} \frac{d\varphi}{dt} = -2\omega, \quad (517)$$

leading to

$$\frac{d\varphi}{dt} = -\frac{2\omega}{\frac{\partial \psi}{\partial \varphi}}. \quad (518)$$

From the last equation one finds that the traveling direction depends on the sign of $\partial \psi / \partial \varphi$. If this quantity is positive the traveling direction is backwards (or ccw when looking in the positive direction of the axis), else it is forwards. The partial derivative of obtained by slightly moving the actual position in positive φ -direction out of the center of the element and reevaluating ψ . This procedure is repeated for all elements. For good accuracy the response from the element for which $\|u^2 + v^2 + w^2\|$ is maximum (always evaluated at the center of the element) is taken.

Finally one word of caution on frequency calculations with axisymmetric elements. Right now, you will only get the eigenmodes corresponding to a nodal diameter of 0, i.e. all axisymmetric modes. If you would like to calculate asymmetric modes, please model a segment with volumetric elements and perform a cyclic symmetry analysis.

6.9.3 Complex frequency analysis

This procedure is used to calculate the eigenvalues and eigenmodes taking the Coriolis forces into account. The latter forces apply as soon as one performs calculations in a rotating frame of reference. Therefore, using the *DLOAD card to define a centrifugal speed in a *FREQUENCY step automatically requires to take into account Coriolis forces. However, in a lot of applications the Coriolis forces are quite small and can be neglected. They may be important for very flexible rotating structures such as thin disks mounted on long rotating axes (rotor dynamics).

The presence of Coriolis forces changes the governing equation into

$$[M] \{\ddot{U}\} + [C] \{\dot{U}\} + [K] \{U\} = \{0\} \quad (519)$$

In a *FREQUENCY analysis the term with the Coriolis matrix $[C]$ is lacking. Now, the solution to the above equation is assumed to be a linear combination of the eigenmodes without Coriolis:

$$\{U(t)\} = \sum_i b_i \{U_i\} e^{i\omega t}. \quad (520)$$

Substituting this assumption into the governing equation and premultiplying the equation with $\{U_j\}^T$ leads to

$$\sum_i b_i \{U_j\}^T [C] \{U_i\} = \left[\frac{\omega_j^2 - \omega^2}{i\omega} \right] b_j. \quad (521)$$

Writing this equation for each value of j yields an eigenvalue problem of the form

$$\omega^2 \{b\} - i\omega [C^*] \{b\} - [Diag(\omega_j^2)] \{b\} = \{0\}. \quad (522)$$

This is a nonlinear eigenvalue problem which can be solved by a Newton-Raphson procedure. Starting values for the procedure are the eigenvalues of the *FREQUENCY step and some values in between. In rare cases an eigenvalue is missed (most often the last eigenvalue requested).

One can prove that the eigenvalues are real, the eigenmodes, however, are usually complex. Therefore, instead of requesting U underneath the *NODE FILE card yielding the real and imaginary part of the displacements it is rather instructive to request PU leading to the size and phase. With the latter information the mode can be properly visualized in CalculiX GraphiX. In addition, the traveling direction is determined in CalculiX and stored in the .dat-file together with the axis reference direction.

Finally, notice that no *DLOAD card of type CORIO is needed in CalculiX. A loading of type CENTRIF in a preceding *STATIC step is sufficient. The usual procedure is indeed:

1. a *STATIC step to define the centrifugal force and calculate the deformation and stresses (may contain NLGEOM, but does not have to).
2. a *FREQUENCY step with PERTURBATION to calculate the eigenfrequencies and eigenmodes taking the centrifugal forces, stress stiffness and deformation stiffness into account. The *FREQUENCY card must include the parameter STORAGE=YES.
3. a *COMPLEX FREQUENCY,CORIOLIS step to include the Coriolis forces.

6.9.4 Buckling analysis

In a linear buckling analysis the initial stiffness matrix is augmented by the initial stress matrix corresponding to the load specified in the *BUCKLE step,

multiplied with a factor. This so-called buckling factor is determined such that the resulting matrix has zero as its lowest eigenfrequency. Ultimately, the buckling load is the buckling factor multiplied with the step load. The buckling factor(s) are always stored in the .dat file. The load specified in a *BUCKLE step should not contain prescribed displacements.

If the perturbation parameter is not activated on the *STEP card, the initial stiffness matrix corresponds to the stiffness matrix of the unloaded structure.

If the perturbation parameter is activated, the initial stiffness matrix includes the deformation and stress stiffness matrix corresponding to the deformation and stress at the end of the last static or dynamic step performed previous to the buckling step, if any, and the material parameters are based on the temperature at the end of that step. In this way, the effect of previous loadings can be included in the buckling analysis.

In a buckling step, all loading previous to the step is removed and replaced by the buckling step's loading, which is reset to zero at the end of the buckling step. Thus, to continue a static step interrupted by a buckling step, the load has to be reapplied after the buckling step. Due to the intrinsic nonlinearity of temperature loading (the material properties usually change with temperature), this type of loading is not allowed in a linear buckling step. If temperature loading is an issue, a nonlinear static or dynamic calculation should be performed instead.

6.9.5 Modal dynamic analysis

In a modal dynamic analysis, triggered by the *MODAL DYNAMIC key word, the response of the structure to dynamic loading is assumed to be a linear combination of the lowest eigenmodes. These eigenmodes are recovered from a file "problem.eig", where "problem" stands for the name of the structure. These eigenmodes must have been determined in a previous step (STORAGE=YES on the *FREQUENCY card or on the *HEAT TRANSFER,FREQUENCY card), either in the same input deck, or in an input deck run previously. The dynamic loading can be defined as a piecewise linear function by means of the *AMPLITUDE key word. Initial conditions can be used for the displacement and the velocity field (cf. *INITIAL CONDITIONS). If the step is immediately preceded by another *MODAL DYNAMIC step the displacement and velocity conditions at the end of the previous step are taken as initial conditions for the present step. This only applies in the absence of the PERTURBATION parameter. If the present step is a perturbation step (i.e. the parameter PERTURBATION was used in the foregoing *FREQUENCY and the present *MODAL DYNAMIC step) the initial displacement field is taken to be zero.

The displacement boundary conditions in a modal dynamic analysis should match zero boundary conditions in the same nodes and same directions in the step used for the determination of the eigenmodes. This corresponds to what is called base motion in ABAQUS. A typical application for nonzero boundary conditions is the base motion of a building due to an earthquake. Notice that in a modal dynamic analysis with base motion non-homogeneous multi-

ple point constraints are not allowed. This applies in particular to single point constraints (boundary conditions) in a non-global coordinate system, such as a cylindrical coordinate system (defined by a *TRANSFORM card). Indeed, boundary conditions in a local coordinate system are internally transformed into non-homogeneous multiple point constraints. Consequently, in a modal dynamic analysis boundary conditions must be defined in the global Cartesian coordinate system.

Nonzero displacement boundary conditions in a modal dynamic analysis require the calculation of the first and second order time derivatives (velocity and acceleration) of the temporarily static solution induced by them. Indeed, based on the nonzero displacement boundary conditions (without any other loading) at time t a static solution can be determined for that time (that's why the stiffness matrix is included in the .eig file). If the nonzero displacement boundary conditions change with time, so will the induced static solution. Now, the solution to the dynamic problem is assumed to be the sum of this temporarily static solution and a linear combination of the lowest eigenmodes. To determine the first and second order time derivatives of the induced static solution, second order accurate finite difference schemes are used based on the solution at times $t - \Delta t$, t and $t + \Delta t$, where Δt is the time increment in the modal dynamic step. At the start of a modal dynamic analysis step the nonzero boundary conditions at the end of the previous step are assumed to have reached steady state (velocity and acceleration are zero). Nonzero displacement boundary conditions can be applied by use of the *BOUNDARY card or the *BASE MOTION card.

Temperature loading or residual stresses are not allowed. If such loading arises, the direct integration dynamics procedure should be used.

The following damping options are available:

- Rayleigh damping by means of the *MODAL DAMPING key card. It assumes the damping matrix to be a linear combination of the problem's stiffness matrix and mass matrix. This splits the problem according to its eigenmodes, and leads to ordinary differential equations. The results are exact for piecewise linear loading, apart from the inaccuracy due to the finite number of eigenmodes.
- Direct damping by means of the *MODAL DAMPING key card. The damping coefficient ζ can be given for each mode separately. The results are exact for piecewise linear loading, apart from the inaccuracy due to the finite number of eigenmodes.
- Dashpot damping by defining dashpot elements (cf. Section 6.2.39).

A modal dynamic analysis can also be performed for a cyclic symmetric structure. To this end, the eigenmodes must have been determined for all relevant modal diameters. For a cyclic modal dynamic analysis there are two limitations:

1. Nonzero boundary conditions are not allowed.

2. The displacements and velocities at the start of a step must be zero.

For cyclic symmetric structures the sector used in the corresponding *FREQUENCY step is expanded into 360° and the eigenmodes are rescaled based on the mass of this expansion, i.e. they are divided by \sqrt{M} (for nodal diameter 0 and $M/2$, the latter only if M is even) or $\sqrt{M/2}$ (other nodal diameters). M is the number of bases sectors in 360° .

Special caution has to be applied if 1D and 2D elements are used. Since these elements are internally expanded into 3D elements, the application of boundary conditions and point forces to nodes requires the creation of multiple point constraints linking the original nodes to their expanded counterparts. These MPC's change the structure of the stiffness and mass matrix. However, the stiffness and mass matrix is stored in the .eig file in the *FREQUENCY step preceding the *MODAL DYNAMIC step. This is necessary, since the mass matrix is needed for the treatment of the initial conditions ([23]) and the stiffness matrix for taking nonzero boundary conditions into account. Summarizing, the *MODAL DYNAMIC step should not introduce point loads or nonzero boundary conditions in nodes in which no point force or boundary condition was defined in the *FREQUENCY step. The value of the point force and boundary conditions in the *FREQUENCY step can be set to zero. An example for the application of point forces to shells is given in shellf.inp of the test example set.

Special effort was undertaken to increase the computational speed for modal dynamic calculations. If time is an issue for you, please take into account the following rules:

- Time varying loads slow down the execution.
- Loads applied in many elements slow down execution. Together with the previous rule this means that e.g. a constantly changing centrifugal load is very detrimental to the performance of the calculation.
- Nonzero displacements, centrifugal loads and gravity loads involve load changes in the complete mesh and slow down execution.
- Point loads act very local and are good for the performance.
- Use the parameter NSET on the *NODE FILE and *EL FILE card to limit output to a small set of nodes in order to accelerate the execution.
- Requesting element variables in the frd output slows down execution. So does requesting nodal forces, since these are derived from the stresses in the integration points. Limiting output to displacements (U) is very beneficial.
- Using the user subroutine cload.f (Section 8.4.2) slows down the execution, since this routine provides the user with the forces in the nodes at stake.

Summarizing, maximal speed will be obtained by applying a constant point load (Heaviside step function) in one node and requesting the displacements only in that node.

6.9.6 Steady state dynamics

In a steady state dynamics analysis, triggered by the *STEADY STATE DYNAMICS key word, the response of the structure to dynamic harmonic loading is assumed to be a linear combination of the lowest eigenmodes. This is very similar to the modal dynamics procedure, except that the load is harmonic in nature and that only the steady state response is of interest. The eigenmodes are recovered from a file "problem.eig", where "problem" stands for the name of the structure. These eigenmodes must have been determined in a previous step (STORAGE=YES on the *FREQUENCY card or on the *HEAT TRANSFER,FREQUENCY card), either in the same input deck, or in an input deck run previously. The dynamic harmonic loading is defined by its amplitude using the usual keyword cards such as *CLOAD and a frequency interval specified underneath the *STEADY STATE DYNAMICS card. The load amplitudes can be modified by means of a *AMPLITUDE key word, which is interpreted as load factor versus frequency (instead of versus time).

If centrifugal loading (cf. *DLOAD) is found, it is assumed that the complete calculation (eigenmode calculation inclusive) has been performed in a relative coordinate system attached to the rotating structure. The centrifugal loading is kept fixed and is not subject to the harmonic excitation. Coriolis forces are activated for any part subject to centrifugal loading. The resulting response (displacements, stresses etc.) from the steady state calculation is in the rotating (relative) system, without the static centrifugal part.

The displacement boundary conditions in a modal dynamic analysis should match zero boundary conditions in the same nodes and same directions in the step used for the determination of the eigenmodes. They can be defined using *BOUNDARY cards or *BASE MOTION cards. The latter can also be used to define an acceleration. Temperature loading or residual stresses are not allowed. If such loading arises, the direct integration dynamics procedure should be used.

One can define loading which is shifted by 90° by using the parameter LOAD CASE = 2 on the loading cards (e.g. *CLOAD).

The frequency range is specified by its lower and upper bound. The number of data points within this range n can also be defined by the user. If no eigenvalues occur within the specified range, this is the total number of data points taken, i.e. including the lower frequency bound and the upper frequency bound. If one or more eigenvalues fall within the specified range, $n - 2$ points are taken in between the lower frequency bound and the lowest eigenfrequency in the range, $n - 2$ between any subsequent eigenfrequencies in the range and $n - 2$ points in between the highest eigenfrequency in the range and the upper frequency bound. In addition, the eigenfrequencies are also included in the data points. Consequently, if m eigenfrequencies belong to the specified range, $(m + 1)(n - 2) + m + 2 = nm - m + n$ data points are taken. They are equally spaced in between the fixed points (lower frequency bound, upper frequency bound and eigenfrequencies) if the user specifies a bias equal to 1. If a different bias is specified, the data points are concentrated about the fixed points.

The following damping options are available:

- Rayleigh damping by means of the *MODAL DAMPING key card. It assumes the damping matrix to be a linear combination of the problem's stiffness matrix and mass matrix. This splits the problem according to its eigenmodes, and leads to ordinary differential equations.
- Direct damping by means of the *MODAL DAMPING key card. The damping coefficient ζ can be given for each mode separately.
- Structural damping by means of the *DAMPING key card. The structural damping is a material characteristic and has to be specified as such underneath a *MATERIAL card.
- Dashpot damping by defining dashpot elements (cf. Section 6.2.39).

For nonharmonic loading, triggered by the parameter HARMONIC=NO on the *STEADY STATE DYNAMICS card, the loading across one period is not harmonic and has to be specified in the time domain. To this end the user can specify the starting time and the final time of one period and describe the loading within this period with *AMPLITUDE cards. Default is the interval [0.,1.] and step loading. Notice that for nonharmonic loading the *AMPLITUDE cards describe amplitude versus TIME. Internally, the nonharmonic loading is expanded into a Fourier series. The user can specify the number of terms which should be used for this expansion, default is 20. The remaining input is the same as for harmonic loading, i.e. the user specifies a frequency range, the number of data points within this range and the bias. The comments above for harmonic loading also apply here, except that, since the loading is defined in the time domain, the LOAD CASE parameter does not make sense here, i.e. LOAD CASE = 1 by default.

A steady state dynamic analysis can also be performed for a cyclic symmetric structure. To this end, the eigenmodes must have been determined for all relevant modal diameters. For a cyclic steady state dynamic analysis the following limitations apply:

1. Nonzero boundary conditions are not allowed.
2. The displacements and velocities at the start of a step must be zero.
3. Dashpot elements are not allowed.
4. Structural damping is not allowed.
5. If centrifugal forces apply, the corresponding Coriolis forces are not taken into account. The user has to assure that they are small enough so that they can be neglected.

For cyclic symmetric structures the sector used in the corresponding *FREQUENCY step is expanded into 360° and the eigenmodes are rescaled based on the mass of this expansion, i.e. they are divided by \sqrt{M} (for nodal diameter 0

and $M/2$, the latter only if M is even) or $\sqrt{M/2}$ (other nodal diameters). M is the number of bases sectors in 360° .

The output of a steady state dynamics calculation is complex, i.e. it consists of a real and an imaginary part. Consequently, if the user saves the displacements to file, there will be two entries: first the real part of the displacement, then the imaginary part. This also applies to all other output variables such as temperature or stress. For the displacements, the temperatures and the stresses the user can request that these variables are stored as magnitude and phase (in that order) by selecting beneath the *NODE FILE card PU, PNT and PHS instead of U, NT and S respectively. This does not apply to the *NODE PRINT card.

Special caution has to be applied if 1D and 2D elements are used. Since these elements are internally expanded into 3D elements, the application of boundary conditions and point forces to nodes requires the creation of multiple point constraints linking the original nodes to their expanded counterparts. These MPC's change the structure of the stiffness and mass matrix. However, the stiffness and mass matrix is stored in the .eig file in the *FREQUENCY step preceding the *STEADY STATE DYNAMICS step. This is necessary, since the mass matrix is needed for the treatment of the initial conditions ([23]) and the stiffness matrix for taking nonzero boundary conditions into account. Summarizing, the *STEADY STATE DYNAMICS step should not introduce point loads or nonzero boundary conditions in nodes in which no point force or boundary condition was defined in the *FREQUENCY step. The value of the point force and boundary conditions in the *FREQUENCY step can be set to zero. An example for the application of point forces to shells is given in shellf.inp of the test example set.

6.9.7 Direct integration dynamic analysis

In a direct integration dynamic analysis, activated by the *DYNAMIC keyword, the equation of motion is integrated in time using the α -method developed by Hilber, Hughes and Taylor [62] (unless the massless contact method is selected; this method is treated at the end of this section). The method is implemented exactly as described in [23]. The parameter α lies in the interval $[-1/3, 0]$ and controls the high frequency dissipation: $\alpha=0$ corresponds to the classical Newmark method inducing no dissipation at all, while $\alpha=-1/3$ corresponds to maximum dissipation (default is $\alpha=-0.05$). The user can choose between an implicit and explicit version of the algorithm. The implicit version (default) is unconditionally stable.

In the explicit version, triggered by the parameter EXPLICIT on the *DYNAMIC keyword card, the mass matrix is lumped, and a forward integration scheme is used so that the solution can be calculated without solving a system of equations. This corresponds to section 2.11.5 in [23]. The mass matrix only has to be set up once at the start of each step and no stiffness matrix is needed. Indeed, the terms in equation (2.475) in [23] in which the $[K]$ matrix is used correspond to the internal forces. They can be calculated directly

from the stresses without need to set up the stiffness matrix. Therefore, each increment is much faster than with the implicit scheme. Furthermore, in the explicit method no iterations are performed, so each increment consists of exactly one iteration. However, the explicit scheme is only conditionally stable: in the α -method, which in CalculiX is also used for explicit calculations (unless the massless contact method is selected), the maximum time step Δt_{cr} is dictated by:

$$\Delta t_{cr} \approx \frac{\Omega_{cr}}{\omega_{max}}, \quad (523)$$

where Ω_{cr} is given by Equation (2.477) in [23] and ω_{max} , which is the highest natural frequency of an element, satisfies for volumetric elements:

$$\omega_{max} \approx 2 \frac{c}{h_{min}}, \quad (524)$$

where c is the velocity of sound for the material at stake and h_{min} is the minimum height of the element. For an isotropic material c satisfies [65]:

$$c = \sqrt{\frac{E(1-\nu)}{(1+\nu)(1-2\nu)\rho}} = \sqrt{\frac{\lambda+2\mu}{\rho}}. \quad (525)$$

It corresponds to the wave speed of longitudinal waves, which are faster than transversal waves, for which the speed amounts to $\sqrt{\mu/\rho}$. For the special case of single crystal materials, which are anisotropic materials characterized by three independent elastic constants, the derivation is more intricate [65]. Here, the derivation will be given for general anisotropic materials.

First, the difference between the phase velocity and group velocity of a wave is explained. A one-dimensional wave is described by

$$f = \cos(kx - \omega t), \quad (526)$$

in which k is the wave number and ω the angular frequency. For constant values of k and ω the wave has a constant amplitude for $kx - \omega t$ constant or a wave speed satisfying:

$$c = \frac{dx}{dt} = \frac{\omega}{k}. \quad (527)$$

Now, adding to this wave a wave with slightly different wave number and angular frequency one obtains:

$$\begin{aligned} g &:= \cos(kx - \omega t) + \cos[(k + \delta k)x - (\omega + \delta \omega)t] \\ &= \cos\left[\left(A + \frac{\delta A}{2}\right) - \frac{\delta A}{2}\right] + \cos\left[\left(A + \frac{\delta A}{2}\right) + \frac{\delta A}{2}\right] \\ &= 2 \cos\left(A + \frac{\delta A}{2}\right) \cos \frac{\delta A}{2}, \end{aligned} \quad (528)$$

where

$$A := kx - \omega t, \quad (529)$$

and

$$\delta A := \delta kx - \delta \omega t. \quad (530)$$

The result in the last line of Equation (528) is the original wave ($\cos(A + \delta A/2) \approx \cos A$) with the so-called phase velocity

$$c_{ph} = \frac{\omega + \delta\omega/2}{k + \delta k/2} \approx \frac{\omega}{k} \quad (531)$$

modulated by a wave whose velocity amounts to the so-called group velocity:

$$c_g = \frac{\delta\omega}{\delta k} \approx \frac{\partial\omega}{\partial k}. \quad (532)$$

The function ω versus k is called the dispersion relationship. If this relationship is linear the phase and group velocity coincide. If not, they differ.

To obtain the phase velocity in three dimensions for an arbitrary material the expression for a three-dimensional planar wave:

$$u_j = Ap_j e^{i(k_m x_m - \omega t)}, \quad (533)$$

where \mathbf{u} is the displacement vector, A is the amplitude, \mathbf{p} is the polarization vector and \mathbf{k} is the wave number vector, is substituted in the general homogeneous equation of motion:

$$\sigma_{ij,i} = \rho \ddot{u}_j, \quad (534)$$

where $\boldsymbol{\sigma}$ is the stress tensor, a comma denotes differentiation w.r.t. space and a dot denotes differentiation w.r.t. time. Indeed, using the elastic relationship

$$\sigma_{ij} = \Sigma_{ijkl} \epsilon_{kl}, \quad (535)$$

the definition of linear strain

$$\epsilon_{kl} = (u_{k,l} + u_{l,k})/2, \quad (536)$$

and the symmetry properties of the elasticity tensor

$$\Sigma_{ijkl} = \Sigma_{jikl} = \Sigma_{ijlk} = \Sigma_{klij}, \quad (537)$$

one obtains the following form for the equation of motion:

$$\Sigma_{ijkl} u_{k,li} = \rho \ddot{u}_j. \quad (538)$$

Substitution of the wave equation now yields:

$$-\Sigma_{ijkl} k_l k_i p_k = -\rho \omega^2 p_j. \quad (539)$$

Setting $k_l := kn_l$ and $k_i := kn_i$ one obtains the eigenvalue problem

$$[\Sigma_{ijkl}n_l n_i]\{p_k\} = \rho c^2\{p_j\}, \quad (540)$$

where $c = \omega/k$ is the phase velocity we are looking for. Since (denoting the matrix on the left hand side by C):

$$C_{jk} = \Sigma_{ijkl}n_l n_i = \Sigma_{ljki}n_l n_i = \Sigma_{kilj}n_l n_i = \Sigma_{ikjl}n_l n_i = C_{kj} \quad (541)$$

the left hand matrix is symmetric. Furthermore, for an arbitrary vector \mathbf{x} one obtains:

$$\Sigma_{ijkl}n_i x_j x_k n_l = \Sigma_{ijkl}x_i n_j x_k n_l \geq 0, \quad (542)$$

since $\Sigma_{ijkl}\epsilon_{ij}\epsilon_{kl} = \sigma_{kl}\epsilon_{kl} \geq 0$ (linear elastic energy) and $x_i n_j$ can be considered as the components of a fictitious strain tensor $\mathbf{x} \otimes \mathbf{n}$. This now means that C is positive definite. Therefore, the eigenvalues are real and positive.

For an isotropic linear elastic material the elasticity tensor satisfies ([23]):

$$\Sigma_{ijkl} = \lambda\delta_{ij}\delta_{kl} + \mu(\delta_{ik}\delta_{jl} + \delta_{il}\delta_{jk}), \quad (543)$$

and component jk of the matrix C amounts to:

$$C_{jk} = \Sigma_{ijkl}n_l n_i = (\lambda + \mu)n_j n_k + \mu\delta_{jk}. \quad (544)$$

Therefore, C can be thought of consisting of the following row vectors (or column vectors, since it is a symmetric matrix):

$$C = \begin{bmatrix} (\lambda + \mu)n_1 \mathbf{n} + \mu \mathbf{e}_1 \\ (\lambda + \mu)n_2 \mathbf{n} + \mu \mathbf{e}_2 \\ (\lambda + \mu)n_3 \mathbf{n} + \mu \mathbf{e}_3 \end{bmatrix}. \quad (545)$$

Setting the determinant of the eigenvalue matrix to zero amounts to:

$$|C - \xi I| = [(\lambda + \mu)n_1 \mathbf{n} + (\mu - \xi)\mathbf{e}_1] \cdot \{[(\lambda + \mu)n_2 \mathbf{n} + \mu \mathbf{e}_2] \times [(\lambda + \mu)n_3 \mathbf{n} + \mu \mathbf{e}_3]\} = 0. \quad (546)$$

Multiplying out the different terms leads to:

$$\begin{aligned} & (\lambda + \mu)n_1(\mu - \xi)^2 \mathbf{n} \cdot (\mathbf{e}_2 \times \mathbf{e}_3) + (\lambda + \mu)n_2(\mu - \xi)^2 \mathbf{e}_1 \cdot (\mathbf{n} \times \mathbf{e}_3) \\ & + (\lambda + \mu)n_3(\mu - \xi)^2 \mathbf{e}_1 \cdot (\mathbf{e}_2 \times \mathbf{n}) + (\mu - \xi)^3 \mathbf{e}_1 \cdot (\mathbf{e}_2 \times \mathbf{e}_3) = 0. \end{aligned} \quad (547)$$

Using identities such as $\mathbf{e}_1 \cdot (\mathbf{e}_2 \times \mathbf{n}) = \mathbf{n} \cdot (\mathbf{e}_1 \times \mathbf{e}_2)$ finally leads to:

$$(\lambda + \mu)(\mu - \xi)^2 + (\mu - \xi)^3 = 0, \quad (548)$$

which leads to a double root $\xi = \mu$ and a single root $\xi = \lambda + 2\mu$. Since $\xi = \rho c^2$ the corresponding phase velocities are $c = \sqrt{\mu/\rho}$ and $c = \sqrt{(\lambda + 2\mu)/\rho}$.

The polarization vectors are the eigenvectors of the system and are obtained by substituting the eigenvalues in the eigenvalue system $C = \xi I$. This leads to the polarization vectors $(n_2, -n_1, 0)$ and $(n_3, 0, -n_1)$ for the double root and (n_1, n_2, n_3) for the single root. The former eigenvectors are orthogonal to the propagation direction of the wave \mathbf{n} and therefore these are transversal waves, whereas the latter eigenvector is parallel to the wave vector and corresponds to a longitudinal wave.

In order to obtain an expression for the group velocity of the wave the derivative of the angular frequency ω w.r.t. the wave number vector \mathbf{k} is needed. Multiplying the eigenvalue Equation [540] with the normalized polarization vector p_j yields:

$$\Sigma_{ijkl} k_l k_i p_k p_j = \rho \omega^2. \quad (549)$$

Taking the derivative w.r.t. k_q leads to:

$$\Sigma_{ijkl} \frac{\partial(k_l k_i)}{\partial k_q} p_k p_j = 2\rho \omega \frac{\partial \omega}{\partial k_q}, \quad (550)$$

or

$$\Sigma_{ijkl} [k_l \delta_{iq} + \delta_{lq} k_i] p_k p_j = 2\rho \omega \frac{\partial \omega}{\partial k_q}. \quad (551)$$

This amounts to:

$$\Sigma_{qjkl} k_l p_k p_j + \Sigma_{ijkq} k_i p_k p_j = 2\rho \omega \frac{\partial \omega}{\partial k_q}. \quad (552)$$

Since $\Sigma_{ijkq} = \Sigma_{kqij} = \Sigma_{qkij} = \Sigma_{qkji}$ the term $\Sigma_{ijkq} k_i p_k p_j$ equals $\Sigma_{qjkl} k_l p_j p_k$, i.e. it is identical with the first term in the equation. Therefore:

$$\Sigma_{qjkl} k_l p_k p_j = \rho \omega \frac{\partial \omega}{\partial k_q}, \quad (553)$$

or

$$\Sigma_{ijkl} k_l p_k p_j = \rho \omega \frac{\partial \omega}{\partial k_i}, \quad (554)$$

which amounts to:

$$(c_g)_i = \frac{\partial \omega}{\partial k_i} = \frac{\Sigma_{ijkl} p_j p_k n_l}{\rho c}. \quad (555)$$

The latter equation expresses the group velocity as a function of the polarization vector, the wave vector and the phase velocity.

Substituting the isotropic elasticity tensor from Equation [543] leads to:

$$\frac{\partial \omega}{\partial k_i} = \frac{1}{\rho c} [\lambda p_i p_k n_k + \mu p_i p_l n_l + \mu n_i]. \quad (556)$$

For the longitudinal wave, knowing that $c_L := c = \sqrt{\lambda + 2\mu/\rho}$, $\mathbf{n} \parallel \mathbf{p}$, $\|\mathbf{n}\| = 1$ and $\|\mathbf{p}\| = 1$ one gets

$$\frac{\partial \omega}{\partial k_i} = \frac{(\lambda + 2\mu)}{\rho c_L} n_i = c_L n_i. \quad (557)$$

For the transversal waves $c_T := c = \sqrt{\mu/\rho}$ and $\mathbf{n} \perp \mathbf{p}$. Therefore:

$$\frac{\partial \omega}{\partial k_i} = \frac{\mu}{\rho c_T} n_i = c_T n_i. \quad (558)$$

Consequently, for an isotropic elastic material the phase and group velocity coincide. For an anisotropic material, such as a single crystal, this is not necessarily the case.

Now, coming back to the original question of a stable time step in an explicit dynamic procedure it is clear that the maximal group speed is to be taken. For an isotropic material this is the longitudinal wave speed. For an anisotropic material the group speed may depend on the wave vector \mathbf{n} . So for a given wave vector Equation [540] has to be solved to yield the phase velocities c and the corresponding polarization vectors \mathbf{p} . The latter ones have to be substituted in Equation [555] to find the group velocities. Now, the wave vector direction has to be varied so as to find the maximum group velocity feasible for a material characterized by the specific elastic tensor σ_{ijkl} . This velocity is then used to calculate ω_{max} and Δt_{cr} .

For the contact spring elements, the idealization of a spring with spring constant k connecting two nodes with nodal masses M_1 and M_2 is used. For such a system one obtains:

$$\omega_{max} = \sqrt{\frac{k(m_1 + m_2)}{m_1 m_2}} \quad (559)$$

where $m_1 = M_1/2$ and $m_2 = M_2/2$. For node-to-face penalty contact and face-to-face penalty contact the nodal mass on the facial sides can be obtained by using the shape functions at the spring location.

To accelerate explicit dynamic calculations mass scaling can be used [70]. It was introduced in CalculiX in the course of a Master Thesis [22]. Applying mass scaling the time increment can be increased, which reduces the overall computational time. In the mass scaling procedure the lumped mass matrix of each element is augmented by a fully populated matrix. The resulting computational increase is, however, negligible, since the LU-decomposition has only to be performed once at the start of the calculation. Mass scaling is triggered by specifying the minimum time increment which the user wants to allow underneath the *DYNAMIC keyword (third parameter). If for any volumetric element the increment size calculated by CalculiX (based on the wave speed) is less than the minimum, the mass of this element is automatically scaled and redistributed such that the total mass of the element does not change. This is obtained by moving mass from the off-diagonal positions of the element

mass matrix onto the diagonal. If any mass scaling takes place, a message is printed and the elements for which the mass was redistributed are stored in file “jobname_WarnElementMassScaled.nam”. This file can be read in any active cgx-session by typing “read jobname_WarnElementMassScaled.nam inp” and the elements can be appropriately visualized. For spring elements the minimum time increment specified by the user is obtained by reducing the spring stiffness. CalculiX stores the maximum spring stiffness reduction to standard output.

Without a minimum time increment no mass scaling nor spring stiffness reduction is applied.

The following damping options are available:

- Rayleigh damping by means of the *DAMPING keyword card underneath a *MATERIAL card. It assumes the damping matrix to be a linear combination of the problem’s stiffness matrix and mass matrix. Although possibly defined for only one material, the coefficients of the linear combination apply to the whole model. For explicit calculations the damping matrix is allowed to be mass matrix proportional only.
- Dashpot damping by defining dashpot elements (cf. Section 6.2.39; for implicit dynamic calculations only).
- Contact damping by defining a contact damping constant and, optionally, a tangent fraction using the *CONTACT DAMPING keyword card (implicit dynamic calculations only).

For explicit dynamic calculations an additional hard contact formulation has been coded within a procedure characterized by:

- the formulation of the contact condition as a set-valued force law [99].
- a reduction of the dynamic equations to static equations (discarding the inertia) for all contact degrees of freedom (master and slave).
- a Verlet time integration scheme.

From now on the method will be called the massless contact method. Its implementation closely follows the frictional flow diagram in [66]. From this publication it is clear that the contactless stiffness matrix is needed. The submatrix related to the contact degrees of freedom (master and slave) is used to set up and solve an inclusion problem in an implicit way. The other submatrices are used to calculate the right hand side of the dynamic equations. The left hand side of these equations is made up of a combination of the mass and damping matrix. It is assumed that these latter matrices do not change during the step, therefore, they can be factorized once at the beginning of the step.

If the NLGEOM parameter is not used on the *STEP card and if all materials are linear the stiffness matrix is calculated only once at the beginning of the step, else it is calculated in each increment which substantially increases the computational time.

Limitations right now include:

- no nonzero boundary conditions are allowed.
- mass scaling cannot be used

The method is triggered by the option TYPE=MASSLESS on all *CONTACT PAIR cards in a *DYNAMIC, EXPLICIT procedure only. In a *STATIC or *DYNAMIC implicit step the contact definition is replaced by TYPE=NODE TO SURFACE. Note that within one input deck only one type of *CONTACT PAIR is allowed. Since the contact is hard, the only parameter is the friction coefficient.

For all dynamic calculations (implicit dynamics, explicit dynamics with penalty contact or explicit dynamics with massless contact) a energy balance can be requested. For implicit dynamics this is done by default, for explicit dynamics the balance is calculated if the user has requested the output variable ENER underneath a *EL PRINT, *EL FILE or *ELEMENT OUTPUT keyword. This increases the computational time.

6.9.8 Heat transfer

In a heat transfer analysis, triggered by the *HEAT TRANSFER procedure card, the temperature is the independent degree of freedom. In essence, the energy equation is solved subject to temperature and flux boundary conditions ([23]). For steady-state calculations it leads to a Laplace-type equation.

The governing equation for heat transfer reads

$$\nabla \cdot (-\boldsymbol{\kappa} \cdot \nabla T) + \rho c \dot{T} = \rho h \quad (560)$$

where $\boldsymbol{\kappa}$ contains the conduction coefficients, ρ is the density, h the heat generation per unit of mass and c is the specific heat.

The temperature can be defined using the *BOUNDARY card using degree of freedom 11. Flux type boundary conditions can consist of any combination of the following:

1. Concentrated flux, applied to nodes, using the *CFLUX card (degree of freedom 11)
2. Distributed flux, applied to surfaces or volumes, using the *DFLUX card
3. Convective flux defined by a *FILM card. It satisfies the equation

$$q = h(T - T_0) \quad (561)$$

where q is the a flux normal to the surface, h is the film coefficient, T is the body temperature and T_0 is the environment temperature (also called sink temperature). CalculiX can also be used for forced convection calculations, in which the sink temperature is an unknown too. This applied to all kinds of surfaces cooled by fluids or gases.

4. Radiative flux defined by a *RADIATE card. The equation reads

$$q = \epsilon(\theta^4 - \theta_0^4) \quad (562)$$

where q is a flux normal to the surface, ϵ is the emissivity, θ is the absolute body temperature (Kelvin) and θ_0 is the absolute environment temperature (also called sink temperature). The emissivity takes values between 0 and 1. A zero value applied to a body with no absorption nor emission and 100 % reflection. A value of 1 applies to a black body. The radiation is assumed to be diffuse (independent of the direction of emission) and gray (independent of the emitted wave length). CalculiX can also be used for cavity radiation, simulating the radiation interaction of several surfaces. In that case, the viewfactors are calculated, see also [39] for the fundamentals of heat transfer and [6] for the calculation of viewfactors.

The calculation of viewfactors involves the solution of a four-fold integral. By using analytical formulas derived by Lambert this integral can be reduced to a two-fold integral. This is applied in CalculiX right now: the interacting surfaces are triangulated and the viewfactor between two triangles is calculated by taking a one-point integration for the base triangle (in the center of gravity) and the analytical formula for the integration over the other triangles covering a hemisphere about the base triangle. One can switch to a more accurate integration over the base triangle by increasing the variable “factor” in subroutine radmatrix, look at the comments in that subroutine. This, however, will increase the computational time.

For a heat transfer analysis the conductivity coefficients of the material are needed (using the *CONDUCTIVITY card) and for transient calculations the heat capacity (using the *SPECIFIC HEAT card). Furthermore, for radiation boundary conditions the *PHYSICAL CONSTANTS card is needed, specifying absolute zero in the user’s temperature scale and the Boltzmann constant.

Notice that a phase transition can be modeled by a local sharp maximum of the specific heat. The energy U per unit of mass needed to complete the phase transition satisfies

$$U = \int_{T_0}^{T_1} C dT, \quad (563)$$

where C is the specific heat and $[T_0, T_1]$ is the temperature interval within which the phase transition takes place.

6.9.9 Acoustics

Linear acoustic calculations in gas are very similar to heat transfer calculations. Indeed, the pressure variation in a space with uniform basis pressure p_0 and density ρ_0 (and consequently uniform temperature T_0 due to the gas law) satisfies

Table 9: Correspondence between the heat equation and the gas momentum equation.

heat quantity	gas quantity
T	p
\mathbf{q}	$\rho_0(\mathbf{a} - \mathbf{f})$
q_n	$\rho_0(a_n - f_n)$
$\boldsymbol{\kappa}$	\mathbf{I}
ρh	$-\rho_0 \nabla \cdot \mathbf{f}$
ρc	$\frac{1}{c_0^2}$

$$\nabla \cdot (-\mathbf{I} \cdot \nabla p) + \frac{1}{c_0^2} \ddot{p} = -\rho_0 \nabla \cdot \mathbf{f}, \quad (564)$$

where \mathbf{I} is the second order unit tensor (or, for simplicity, unit matrix) and c_0 is the speed of sound satisfying:

$$c_0 = \sqrt{\gamma R T_0}. \quad (565)$$

γ is the ratio of the heat capacity at constant pressure divided by the heat capacity at constant volume ($\gamma = 1.4$ for normal air), R is the specific gas constant ($R = 287 \text{ J}/(\text{kgK})$ for normal air) and T_0 is the absolute basis temperature (in K). Furthermore, the balance of momentum reduces to:

$$\nabla p = \rho_0(\mathbf{f} - \mathbf{a}). \quad (566)$$

For details, the reader is referred to [25] and [2]. Equation (564) is the well-known wave equation. By comparison with the heat equation, the correspondence in Table (9) arises.

Notice, however, that the time derivative in the heat equation is first order, in the gas momentum equation it is second order. This means that the transient heat transfer capability in CalculiX can NOT be used for the gas equation. However, the frequency option can be used and the resulting eigenmodes can be taken for a subsequent modal dynamic or steady state dynamics analysis. Recall that the governing equation for solids also has a second order time derivative ([23]).

For the driving terms one obtains:

$$\int_A \rho_0(a_n - f_n) dA - \int_V \rho_0 \nabla \cdot \mathbf{f} dV = \int_A \rho_0 a_n dA, \quad (567)$$

which means that the equivalent of the normal heat flux at the boundary is the basis density multiplied with the acceleration. Consequently, at the boundary either the pressure must be known or the acceleration.

Table 10: Correspondence between the heat equation and the shallow water equation.

heat quantity	shallow water quantity
T	η
\mathbf{q}	$\frac{\partial}{\partial t}(H\bar{\mathbf{v}})$
q_n	$H\frac{\partial}{\partial t}(\bar{v}_n)$
κ	$Hg\mathbf{I}$
ρh	—
ρc	1

6.9.10 Shallow water motion

For incompressible fluids integration of the governing equations over the fluid depth and subsequent linearization leads to the following equation:

$$\nabla \cdot (-gH\mathbf{I} \cdot \nabla \eta) + \ddot{\eta} = 0, \quad (568)$$

where g is the earth acceleration, H is the fluid depth measured from a reference level, \mathbf{I} is the unit tensor and η is the fluid height with respect to the reference level. Usually the fluid level at rest is taken as reference level. The derivation of the equation is described in [109] and can be obtained by a linearization of the equations derived in Section 6.9.20. The following assumptions are made:

- no viscosity
- no Coriolis forces
- no convective acceleration
- $H + \eta \approx H$

Due to the integration process the above equation is two-dimensional, i.e. only the surface of the fluid has to be meshed. By comparison with the heat equation, the correspondence in Table (10) arises. Therefore, shallow water motion can be simulated using the *HEAT TRANSFER procedure.

The quantity $\bar{\mathbf{v}}$ is the average velocity over the depth and \bar{v}_n is its component orthogonal to the boundary of the domain. Due to the averaging the equations hold for small depths only (shallow water approximation). Notice that the equivalence of the heat conduction coefficient is proportional to the depth, which is a geometric quantity. For a different depth a different conduction coefficient must be defined.

There is no real two-dimensional element in CalculiX. Therefore, the two-dimensional Helmholtz equation has to be simulated by expanding the two-dimensional fluid surface to a three-dimensional layer with constant width and

applying the boundary conditions in such a way that no variation occurs over the width.

Notice that, similar to the acoustic equations, the shallow water equations are of the Helmholtz type leading to a hyperbolic system. For instationary applications eigenmodes can be calculated and a modal analysis performed.

6.9.11 Hydrodynamic lubrication

In hydrodynamic lubrication a thin oil film constitutes the interface between a static part and a part rotating at high speed in all kinds of bearings. A quantity of major interest to engineers is the load bearing capacity of the film, expressed by the pressure. Integrating the hydrodynamic equations over the width of the thin film leads to the following equation [31]:

$$\nabla \cdot \left(-\frac{h^3 \bar{\rho}}{12\mu_v} \mathbf{I} \cdot \nabla p \right) = - \left(\frac{\mathbf{v}_b + \mathbf{v}_a}{2} \right) \cdot \nabla (h\bar{\rho}) - \frac{\partial(h\bar{\rho})}{\partial t} - \dot{m}_\Omega, \quad (569)$$

where h is the film thickness, $\bar{\rho}$ is the mean density across the thickness, p is the pressure, μ_v is the dynamic viscosity of the fluid, \mathbf{v}_a is the velocity on one side of the film, \mathbf{v}_b is the velocity at the other side of the film and \dot{m}_Ω is the resulting volumetric flux (volume per second and per unit of area) leaving the film through the porous walls (positive if leaving the fluid). This term is zero if the walls are not porous.

For practical calculations the density and thickness of the film is assumed to be known, the pressure is the unknown. By comparison with the heat equation, the correspondence in Table (11) arises. $\bar{\mathbf{v}}$ is the mean velocity over the film, \bar{v}_n its component orthogonal to the boundary. Since the governing equation is the result of an integration across the film thickness, it is again two-dimensional and applies in the present form to a plane film. Furthermore, observe that it is a steady state equation (the time change of the density on the right hand side is assumed known) and as such it is a Poisson equation. Here too, just like for the shallow water equation, the heat transfer equivalent of a spatially varying layer thickness is a spatially varying conductivity coefficient.

6.9.12 Irrotational incompressible inviscid flow

If incompressible flow is irrotational a potential ϕ exists for the velocity field such that $\mathbf{v} = -\nabla\phi$. Furthermore, if the flow is inviscid one can prove that if a flow is irrotational at any instant in time, it remains irrotational for all subsequent time instants [109]. The continuity equation now reads

$$\nabla \cdot (-\mathbf{I} \cdot \nabla \phi) = 0, \quad (570)$$

and the balance of momentum for gravitational flow yields

$$\frac{\partial \mathbf{v}}{\partial t} + \nabla \left(\frac{p}{\rho_0} + \frac{\mathbf{v} \cdot \mathbf{v}}{2} + gz \right) = 0, \quad (571)$$

Table 11: Correspondence between the heat equation and the dynamic lubrication equation.

heat quantity	dynamic lubrication quantity
T	p
\mathbf{q}	$\bar{\rho}h\bar{\mathbf{v}}$
q_n	$\bar{\rho}h\bar{v}_n$
κ	$\frac{h^3\bar{\rho}}{12\mu_v}\mathbf{I}$
ρh	$-\left(\frac{\mathbf{v}_b+\mathbf{v}_a}{2}\right)\cdot\nabla(h\bar{\rho})-\frac{\partial(h\bar{\rho})}{\partial t}-\dot{m}_\Omega$
ρc	—

Table 12: Correspondence between the heat equation and the equation for incompressible irrotational inviscid flow.

heat quantity	irrotational flow quantity
T	ϕ
\mathbf{q}	\mathbf{v}
q_n	v_n
κ	\mathbf{I}
ρh	0
ρc	—

where g is the earth acceleration, p is the pressure, ρ_0 is the density and z is the coordinate in earth direction. By comparison with the heat equation, the correspondence in Table (12) arises.

Once ϕ is determined, the velocity \mathbf{v} is obtained by differentiation and the pressure p can be calculated through the balance of momentum. Although irrotational incompressible inviscid flow sounds very special, the application field is rather large. Flow starting from rest is irrotational since the initial field is irrotational. Flow at speeds below 0.3 times the speed of sound can be considered to be incompressible. Finally, the flow outside the tiny boundary layer around an object is inviscid. A favorite examples is the flow around a wing profile. However, if the boundary layer separates and vortices arise the above theory cannot be used any more. For further applications see [44].

6.9.13 Electrostatics

The governing equations of electrostatics are

$$\mathbf{E} = -\nabla V \quad (572)$$

and

Table 13: Correspondence between the heat equation and the equation for electrostatics (metals and free space).

heat	electrostatics
T	V
\mathbf{q}	\mathbf{E}
q_n	$E_n = \frac{j_n}{\sigma}$
κ	\mathbf{I}
ρh	$\frac{\rho^e}{\epsilon_0}$
ρc	—

$$\nabla \cdot \mathbf{E} = \frac{\rho^e}{\epsilon_0}, \quad (573)$$

where \mathbf{E} is the electric field, V is the electric potential, ρ^e is the electric charge density and ϵ_0 is the permittivity of free space ($\epsilon_0 = 8.8542 \times 10^{-12} \text{ C}^2/\text{Nm}^2$). The electric field \mathbf{E} is the force on a unit charge.

In metals, it is linked to the current density \mathbf{j} by the electric conductivity σ_c [5]:

$$\mathbf{j} = \sigma_c \mathbf{E}. \quad (574)$$

In free space, the electric field is locally orthogonal to a conducting surface. Near the surface the size of the electric field is proportional to the surface charge density σ [27]:

$$\sigma = E_n \epsilon_0. \quad (575)$$

Substituting Equation (572) into Equation (573) yields the governing equation

$$\nabla \cdot (-\mathbf{I} \cdot \nabla V) = \frac{\rho^e}{\epsilon_0}. \quad (576)$$

Accordingly, by comparison with the heat equation, the correspondence in Table (13) arises. Notice that the electrostatics equation is a steady state equation, and there is no equivalent to the heat capacity term.

An application of electrostatics is the potential drop technique for crack propagation measurements: a predefined current is sent through a conducting specimen. Due to crack propagation the specimen section is reduced and its electric resistance increases. This leads to an increase of the electric potential across the specimen. A finite element calculation for the specimen (electrostatic equation with $\rho^e = 0$) can determine the relationship between the potential and the crack length. This calibration curve can be used to derive the actual crack length from potential measurements during the test.

Table 14: Correspondence between the heat equation and the equation for electrostatics (dielectric media).

heat	electrostatics
T	V
\mathbf{q}	\mathbf{D}
q_n	D_n
$\boldsymbol{\kappa}$	$\epsilon \mathbf{I}$
ρh	ρ^f
ρc	–

Another application is the calculation of the capacitance of a capacitor. Assuming the space within the capacitor to be filled with air, the electrostatic equation with $\rho^e = 0$ applies (since there is no charge within the capacitor). Fixing the electric potential on each side of the capacitor (to e.g. zero and one), the electric field can be calculated by the thermal analogy. This field leads to a surface charge density by Equation (575). Integrating this surface charge leads to the total charge. The capacitance is defined as this total charge divided by the electric potential difference (one in our equation).

For dielectric applications Equation (573) is modified into

$$\nabla \cdot \mathbf{D} = \rho^f, \quad (577)$$

where \mathbf{D} is the electric displacement and ρ^f is the free charge density [27]. The electric displacement is coupled with the electric field by

$$\mathbf{D} = \epsilon \mathbf{E} = \epsilon_0 \epsilon_r \mathbf{E}, \quad (578)$$

where ϵ is the permittivity and ϵ_r is the relative permittivity (usually $\epsilon_r > 1$, e.g. for silicon $\epsilon_r=11.68$). Now, the governing equation yields

$$\nabla \cdot (-\epsilon \mathbf{I} \cdot \nabla V) = \rho^f \quad (579)$$

and the analogy in Table (14) arises. The equivalent of Equation (575) now reads

$$\sigma = D_n. \quad (580)$$

The thermal equivalent of the total charge on a conductor is the total heat flow. Notice that ϵ may be a second-order tensor for anisotropic materials.

6.9.14 Stationary groundwater flow

The governing equations of stationary groundwater flow are [32]

$$\mathbf{v} = -\mathbf{k} \cdot \nabla h \quad (581)$$

Table 15: Correspondence between the heat equation and the equation for groundwater flow.

heat	groundwater flow
T	h
\mathbf{q}	\mathbf{v}
q_n	v_n
$\boldsymbol{\kappa}$	\mathbf{k}
ρh	0
ρc	–

(also called Darcy's law) and

$$\nabla \cdot \mathbf{v} = 0, \quad (582)$$

where \mathbf{v} is the discharge velocity, \mathbf{k} is the permeability tensor and h is the total head defined by

$$h = \frac{p}{\rho g} + z. \quad (583)$$

In the latter equation p is the groundwater pressure, ρ is its density and z is the height with respect to a reference level. The discharge velocity is the quantity of fluid that flows through a unit of total area of the porous medium in a unit of time.

The resulting equation now reads

$$\nabla \cdot (-\mathbf{k} \cdot \nabla h) = 0. \quad (584)$$

Accordingly, by comparison with the heat equation, the correspondence in Table (15) arises. Notice that the groundwater flow equation is a steady state equation, and there is no equivalent to the heat capacity term.

Possible boundary conditions are:

1. unpermeable surface under water. Taking the water surface as reference height and denoting the air pressure by p_0 one obtains for the total head:

$$h = \frac{p_0 - \rho g z}{\rho g} + z = \frac{p_0}{\rho g}. \quad (585)$$

2. surface of seepage, i.e. the interface between ground and air. One obtains:

$$h = \frac{p_0}{\rho g} + z. \quad (586)$$

3. unpermeable boundary: $v_n = 0$

4. free surface, i.e. the upper boundary of the groundwater flow within the ground. Here, two conditions must be satisfied: along the free surface one has

$$h = \frac{p_0}{\rho g} + z. \quad (587)$$

In the direction \mathbf{n} perpendicular to the free surface $v_n = 0$ must be satisfied. However, the problem is that the exact location of the free surface is not known. It has to be determined iteratively until both equations are satisfied.

6.9.15 Diffusion mass transfer in a stationary medium

The governing equations for diffusion mass transfer are [39]

$$\mathbf{j}_A = -\rho \mathbf{D}_{AB} \nabla m_A \quad (588)$$

and

$$\nabla \cdot \mathbf{j}_A + \dot{n}_A = \frac{\partial \rho_A}{\partial t}, \quad (589)$$

where

$$m_A = \frac{\rho_A}{\rho_A + \rho_B} \quad (590)$$

and

$$\rho = \rho_A + \rho_B. \quad (591)$$

In these equations \mathbf{j}_A is the mass flux of species A, \mathbf{D}_{AB} is the mass diffusivity, m_A is the mass fraction of species A and ρ_A is the density of species A. Furthermore, \dot{n}_A is the rate of increase of the mass of species A per unit volume of the mixture. Another way of formulating this is:

$$\mathbf{J}_A^* = -C \mathbf{D}_{AB} \nabla x_A \quad (592)$$

and

$$\nabla \cdot \mathbf{J}_A^* + \dot{N}_A = \frac{\partial C_A}{\partial t}. \quad (593)$$

where

$$x_A = \frac{C_A}{C_A + C_B} \quad (594)$$

and

$$C = C_A + C_B. \quad (595)$$

Table 16: Correspondence between the heat equation and mass diffusion equation.

heat	mass diffusion	
T	ρ	C_A
\mathbf{q}	$\dot{\mathbf{j}}_A$	\mathbf{J}_A^*
q_n	\dot{j}_{A_n}	$J_{A_n}^*$
$\boldsymbol{\kappa}$	\mathbf{D}_{AB}	\mathbf{D}_{AB}
ρh	\dot{n}_A	\dot{N}_A
ρc	1	1

Here, \mathbf{J}_A^* is the molar flux of species A, \mathbf{D}_{AB} is the mass diffusivity, x_A is the mole fraction of species A and C_A is the molar concentration of species A. Furthermore, \dot{N}_A is the rate of increase of the molar concentration of species A.

The resulting equation now reads

$$\nabla \cdot (-\rho \mathbf{D}_{AB} \cdot \nabla m_A) + \frac{\partial \rho_A}{\partial t} = \dot{n}_A. \quad (596)$$

or

$$\nabla \cdot (-C \mathbf{D}_{AB} \cdot \nabla x_A) + \frac{\partial C_A}{\partial t} = \dot{N}_A. \quad (597)$$

If C and ρ are constant, these equations reduce to:

$$\nabla \cdot (-\mathbf{D}_{AB} \cdot \nabla \rho_A) + \frac{\partial \rho_A}{\partial t} = \dot{n}_A. \quad (598)$$

or

$$\nabla \cdot (-\mathbf{D}_{AB} \cdot \nabla C_A) + \frac{\partial C_A}{\partial t} = \dot{N}_A. \quad (599)$$

Accordingly, by comparison with the heat equation, the correspondence in Table (16) arises.

6.9.16 Aerodynamic Networks

Aerodynamic networks are made of a concatenation of network elements filled with a compressible medium which can be considered as an ideal gas. An ideal gas satisfies

$$p = \rho RT, \quad (600)$$

where p is the pressure, ρ is the density, R is the specific gas constant and T is the absolute temperature. A network element (see section 6.2.33) consists of three nodes: in the corner nodes the temperature and pressure are the unknowns, in the midside node the mass flow is unknown. The corner nodes play

the role of crossing points in the network, whereas the midside nodes represent the flow within one element. To determine these unknowns, three types of equations are available: conservation of mass and conservation of energy in the corner nodes and conservation of momentum in the midside node. Right now, only stationary flow is considered.

The stationary form of the conservation of mass for compressible fluids is expressed by:

$$\nabla \cdot (\rho \mathbf{v}) = 0 \quad (601)$$

where \mathbf{v} the velocity vector. Integration over all elements connected to corner node i yields:

$$\sum_{j \in \text{in}} \dot{m}_{ij} = \sum_{j \in \text{out}} \dot{m}_{ij}, \quad (602)$$

where \dot{m}_{ij} is the mass flow from node i to node j or vice versa. In the above equation \dot{m}_{ij} is always positive.

The conservation of momentum or element equations are specific for each type of fluid section attributed to the element and are discussed in Section 6.4 on fluid sections. For an element with corner nodes i, j it is generally of the form $f(p_{t_i}, T_{t_i}, \dot{m}_{ij}, p_{t_j}) = 0$ (for positive \dot{m}_{ij} , where p is the total pressure and T_t is the total temperature), although more complex relationships exist. Notice in particular that the temperature pops up in this equation (this is not the case for hydraulic networks).

The conservation of energy for an ideal gas in stationary form requires ([30], see also Equation (37)):

$$\nabla \cdot (\rho h_t \mathbf{v}) = -\nabla \cdot \mathbf{q} + \rho h^\theta + \rho \mathbf{f} \cdot \mathbf{v}, \quad (603)$$

where \mathbf{q} is the external heat flux, h^θ is the body flux per unit of mass and \mathbf{f} is the body force per unit of mass. h_t is the total enthalpy satisfying:

$$h_t = c_p T + \frac{\mathbf{v} \cdot \mathbf{v}}{2}, \quad (604)$$

where c_p is the specific heat at constant pressure and T is the absolute temperature (in Kelvin). This latter formula only applies if c_p is considered to be independent of the temperature. This is largely true for a lot of industrial applications. In this connection the reader be reminded of the definition of total temperature and total pressure (also called stagnation temperature and stagnation pressure, respectively):

$$T_t = T + \frac{\mathbf{v} \cdot \mathbf{v}}{2c_p}, \quad (605)$$

and

$$\frac{p_t}{p} = \left(\frac{T_t}{T} \right)^{\frac{\kappa}{\kappa-1}}, \quad (606)$$

where $\kappa = c_p/c_v$. T and p are also called the static temperature and static pressure, respectively.

If the corner nodes of the elements are considered to be large chambers, the velocity \mathbf{v} is zero. In that case, the total quantities reduce to the static ones, and integration of the energy equation over all elements belonging to end node i yields [23]:

$$\sum_{j \in \text{in}} c_p(T_j)T_j \dot{m}_{ij} - c_p(T_i)T_i \sum_{j \in \text{out}} \dot{m}_{ij} + \bar{h}(T_i, T)(T - T_i) + m_i h_i^\theta = 0, \quad (607)$$

where $\bar{h}(T_i, T)$ is the convection coefficient with the walls. Notice that, although this is not really correct, a slight temperature dependence of c_p is provided for. If one assumes that all flow entering a node must also leave it and taking for both the c_p value corresponding to the mean temperature value of the entering flow, one arrives at:

$$\sum_{j \in \text{in}} c_p(T_m)(T_j - T_i) \dot{m}_{ij} + \bar{h}(T_i, T)(T - T_i) + m_i h_i^\theta = 0. \quad (608)$$

where $T_m = (T_i + T_j)/2$.

The calculation of aerodynamic networks is triggered by the *HEAT TRANSFER keyword card. Indeed, such a network frequently produces convective boundary conditions for solid mechanics heat transfer calculations. However, network calculations can also be performed on their own.

A particularly delicate issue in networks is the number of boundary conditions which is necessary to get a unique solution. To avoid ending up with more or less equations than unknowns, the following rules should be obeyed:

- The pressure and temperature should be known in those nodes where mass flow is entering the network. Since it is not always clear whether at a specific location mass flow is entering or leaving, it is advisable (though not necessary) to prescribe the pressure and temperature at all external connections, i.e. in the nodes connected to dummy network elements.
- A node where the pressure is prescribed should be connected to a dummy network element. For instance, if you have a closed circuit add an extra dummy network element to the node in which you prescribe the pressure.

Output variables are the mass flow (key MF on the *NODE PRINT or *NODE FILE card), the total pressure (key PN — network pressure — on the *NODE PRINT card and PT on the *NODE FILE card) and the total temperature (key NT on the *NODE PRINT card and TT on the *NODE FILE card). Notice that the labels for the *NODE PRINT keyword are more generic in nature, for the *NODE FILE keyword they are more specific. These are the primary variables in the network. In addition, the user can also request the static temperature (key TS on the *NODE FILE card). Internally, in network nodes, components one to three of the structural displacement field are used for

the mass flow, the total pressure and the static temperature, respectively. So their output can also be obtained by requesting U on the *NODE PRINT card.

6.9.17 Hydraulic Networks

Hydraulic networks are made of a concatenation of network elements (see section 6.2.33) filled with an incompressible medium. A network element consists of three nodes: in the corner nodes the temperature and pressure are the unknowns, in the midside node the mass flow is unknown. The corner nodes play the role of crossing points in the network, whereas the midside nodes represent the flow within one element. To determine these unknowns, three types of equations are available: conservation of mass and conservation of energy in the corner nodes and conservation of momentum in the midside node. Right now, only stationary flow is considered.

The stationary form of the conservation of mass for incompressible fluids is expressed by:

$$\nabla \cdot \mathbf{v} = 0 \quad (609)$$

where ρ is the density and \mathbf{v} the velocity vector. Integration over all elements connected to an corner node yields:

$$\sum_{j \in \text{in}} \dot{m}_{ij} = \sum_{j \in \text{out}} \dot{m}_{ij}, \quad (610)$$

where \dot{m}_{ij} is the mass flow from node i to node j or vice versa. In the above equation \dot{m}_{ij} is always positive.

The conservation of momentum reduces to the Bernoulli equation. It is obtained by projecting the general momentum equation (substitute Equation (1.535) into Equation (1.334) in [23]) on a flow line. Since a flow line is everywhere locally parallel to the velocity vector, this amounts to a multiplication by:

$$\frac{dx_k}{ds} = \frac{v_k}{\|\mathbf{v}\|} \quad (611)$$

leading to (where for the gravity $f_k = gz_{,k}$ with z the coordinate perpendicular to the earth surface was inserted):

$$\rho \left(\frac{v_k}{\|\mathbf{v}\|} \frac{\partial v_k}{\partial t} + \frac{v_k v_{k,l} v_l}{\|\mathbf{v}\|} \right) = t_{kl,l} \frac{dx_k}{ds} - p_{,k} \frac{dx_k}{ds} - \rho g z_{,k} \frac{dx_k}{ds}. \quad (612)$$

Since

$$\frac{v_k v_{k,l} v_l}{\|\mathbf{v}\|} = v_k v_{k,l} \frac{dx_l}{ds} = \frac{1}{2} (v_k v_k)_{,l} \frac{dx_l}{ds} = \frac{d}{ds} \left(\frac{v_k v_k}{2} \right), \quad (613)$$

one obtains:

$$\rho \left[\frac{\partial \|\mathbf{v}\|}{\partial t} + \frac{d}{ds} \left(\frac{v_k v_k}{2} \right) \right] = t_{kl,l} \frac{dx_k}{ds} - \frac{dp}{ds} - \rho g \frac{dz}{ds}. \quad (614)$$

Dividing by ρg and integration from s_1 to s_2 yields:

$$\frac{1}{g} \int_{s_1}^{s_2} \frac{\partial \|\mathbf{v}\|}{\partial t} ds + \frac{\Delta}{1} \frac{\|\mathbf{v}\|^2}{2g} = \frac{1}{\rho g} \int_{s_1}^{s_2} t_{kl,l} dx_k - \frac{\Delta}{1} \frac{p}{\rho g} - \frac{\Delta}{1} z. \quad (615)$$

Applying this equation for steady state flow within an element with corner nodes i and j reads:

$$z_i + \frac{p_i}{\rho g} + \frac{\dot{m}_{ij}^2}{2\rho^2 A_i^2 g} = z_j + \frac{p_j}{\rho g} + \frac{\dot{m}_{ij}^2}{2\rho^2 A_j^2 g} + \Delta F_i^j, \quad (616)$$

where

$$\Delta F_i^j := \int_i^j t_{kl,l} dx_k. \quad (617)$$

Here, z is the height of the node, p the pressure, ρ the density, g the gravity acceleration, A the cross section in the node and ΔF_i^j is the head loss across the element. The head loss is positive if the flow runs from i to j , else it is negative (or has to be written on the other side of the equation). The head losses for different types of fluid sections are described in Section 6.5.

Notice that the height of the node is important, therefore, for hydraulic networks the gravity vector must be defined for each element using a *DLOAD card.

The conservation of energy in stationary form requires ([23]):

$$c_p \nabla \cdot (\rho T \mathbf{v}) = -\nabla \cdot \mathbf{q} + \rho h^\theta, \quad (618)$$

where \mathbf{q} is the external heat flux, h^θ is the body flux per unit of mass, c_p is the specific heat at constant pressure (which, for a fluid, is also the specific heat at constant specific volume, i.e. $c_p = c_v$ [30]) and T is the absolute temperature (in Kelvin). Integration of the energy equation over all elements belonging to end node i yields:

$$c_p(T_i) \sum_{j \in \text{in}} T_j \dot{m}_{ij} - c_p(T_i) T_i \sum_{j \in \text{out}} \dot{m}_{ij} + \bar{h}(T_i, T)(T - T_i) + m_i h_i^\theta = 0, \quad (619)$$

where $\bar{h}(T_i, T)$ is the convection coefficient with the walls. If one assumes that all flow entering a node must also leave it and taking for both the c_p value corresponding to the mean temperature value of the entering flow, one arrives at:

$$\sum_{j \in \text{in}} c_p(T_m)(T_j - T_i) \dot{m}_{ij} + \bar{h}(T_i, T)(T - T_i) + m_i h_i^\theta = 0. \quad (620)$$

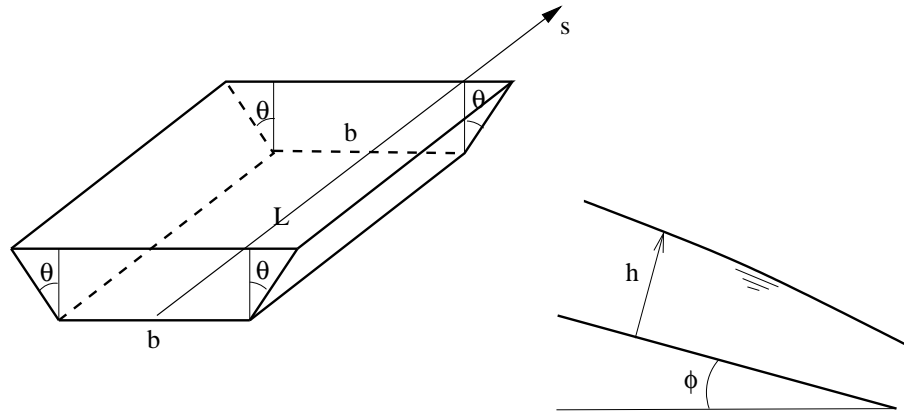

Figure 146: Channel geometry

where $T_m = (T_i + T_j)/2$.

The calculation of hydraulic networks is triggered by the *HEAT TRANSFER keyword card. Indeed, such a network frequently produces convective boundary conditions for solid mechanics heat transfer calculations. However, network calculations can also be performed on their own, i.e. it is allowed to do *HEAT TRANSFER calculations without any solid elements.

To determine appropriate boundary conditions for a hydraulic network the same rules apply as for aerodynamic networks.

Output variables are the mass flow (key MF on the *NODE PRINT or *NODE FILE card), the static pressure (key PN — network pressure — on the *NODE PRINT card and PS on the *NODE FILE card) and the total temperature (key NT on the *NODE PRINT card and TT on the *NODE FILE card). Notice that the labels for the *NODE PRINT keyword are more generic in nature, for the *NODE FILE keyword they are more specific. These are the primary variables in the network. Internally, in network nodes, components one to two of the structural displacement field are used for the mass flow and the static pressure, respectively. So their output can also be obtained by requesting U on the *NODE PRINT or *NODE FILE card.

Notice that for liquids the total temperature virtually coincides with the static temperature. Indeed, since

$$T_t - T = v^2/(2c_p), \quad (621)$$

the difference between total and static temperature for a fluid velocity of 5 m/s and $c_p = 4218 \text{ J}/(\text{kg}\cdot\text{K})$ (water) amounts to 0.0030 K. This is different from the gases since typical gas velocities are much higher (speed of sound is 340 m/s) and c_p for gases is usually lower.

6.9.18 Turbulent Flow in Open Channels

The turbulent flow in open channels can be approximated by one-dimensional network calculations. For the theoretical background the reader is referred to [16] and especially [11] (in Dutch). [21] contains information on the solution of transient problems and (transient and steady state) analytical examples. The governing equation is the Bresse equation, which is a special form of the Bernoulli equation. For its derivation we start from Equation (614), which we write down for a flow line near the bottom of the channel in the form:

$$\frac{1}{g} \left[\frac{\partial \|\mathbf{v}\|}{\partial t} + \frac{d}{ds} \left(\frac{v_k v_k}{2} \right) \right] = \frac{1}{\rho g} t_{kl,l} \frac{dx_k}{ds} - \frac{1}{\rho g} \frac{dp}{ds} - \frac{dz}{ds}. \quad (622)$$

Assuming:

1. steady-state flow
2. each cross section is hydrostatic
3. the velocity is constant across each cross section
4. the velocity vector is perpendicular to each cross section,

one arrives at:

$$\frac{d}{ds} \left(\frac{Q^2}{2gA^2} \right) = -S_f - \frac{dh}{ds} \sqrt{1 - S_0^2} + S_0, \quad (623)$$

where (Figure 146) h is the water depth (measured perpendicular to the channel floor), s is the length along the bottom, $S_0 = \sin(\phi)$, where ϕ is the angle the channel floor makes with a horizontal line, S_f is a friction term (head loss per unit of length; results from the viscous stresses), g is the earth acceleration, Q is the volumetric flow (mass flow divided by the fluid density) and A is the area of the cross section. This also amounts to:

$$\frac{Q}{gA^2} \frac{dQ}{ds} - \frac{Q^2}{gA^3} \left[\frac{\partial A}{\partial s} \Big|_{h=cte} + \frac{\partial A}{\partial h} \frac{dh}{ds} \right] + \frac{dh}{ds} \sqrt{1 - S_0^2} = S_0 - S_f. \quad (624)$$

Assuming no change in flow ($dQ/ds=0$) and a trapezoidal cross section (for which $\partial A/\partial h = B$, where B is the width at the free surface) one finally obtains (Bresse equation):

$$\frac{dh}{ds} = \frac{S_0 - S_f + \frac{1}{g} \frac{Q^2}{A^3} \frac{\partial A}{\partial s}}{\sqrt{1 - S_0^2} - \frac{Q^2 B}{gA^3}}, \quad (625)$$

For S_f several formulas have been proposed. In CalculiX the White-Colebrook and the Manning formula are implemented. The White-Colebrook formula reads

$$S_f = \frac{f}{8g} \frac{Q^2 P}{A^3}, \quad (626)$$

where f is the friction coefficient determined by Equation (162), and P is the wetted circumference of the cross section. The Manning formula reads

$$S_f = \frac{n^2 Q^2 P^{4/3}}{A^{10/3}} \quad (627)$$

where n is the Manning coefficient, which has to be determined experimentally.

In CalculiX, the channel cross section has to be trapezoidal (Figure 146). For this geometry the following relations apply:

$$A = h(b + h \tan \theta), \quad (628)$$

$$P = b + \frac{2h}{\cos \theta} \quad (629)$$

and

$$B = b + 2h \tan \theta. \quad (630)$$

All geometry parameters are assumed not to change within an element (allowing a changing geometry within an element leads to complications, e.g. a non-constant width b may lead to a fall (i.e. a transition from subcritical flow to supercritical flow) within one and the same element. In CalculiX, a changing width can be treated in a discontinuous way by using the Contraction element). Consequently:

$$\frac{\partial A}{\partial s} = 0. \quad (631)$$

and one obtains the Bresse equation in the form (for White-Colebrook):

$$\frac{dh}{ds} = \frac{S_0 - \frac{f}{8g} \frac{Q^2 P}{A^3}}{\sqrt{1 - S_0^2 - \frac{Q^2 B}{g A^3}}}. \quad (632)$$

Recall that in the above formula B , P and A are a function of the depth h . The numerator has for positive S_0 exactly one root, which is called the normal depth. For this depth there is no change in h along the channel. For zero or negative S_0 there is no root. The denominator has always exactly one root, called the critical depth. For this depth the slope is infinite. It is very weakly dependent on S_0 . Notice that both the normal depth (if defined) and the critical depth are monotonically increasing functions of the volumetric fluid flow.

Let us for the time being assume that S_0 is positive. For h close to zero both the denominator and numerator are negative, so the slope of dh/ds is positive. For high enough values of h both are positive, which also leads to a positive slope for dh/ds . Only for values of h in between the normal and critical depth the slope dh/ds is negative. For low values of S_0 the normal depth exceeds the critical depth and the corresponding channel slope (slope of the bottom) is called weak. The corresponding water curves are denoted by A1, A2 and A3

depending on whether the curve is above the normal depth, in between normal depth and critical depth or below the critical depth, respectively. For high values of S_0 the critical depth exceeds the normal depth and the corresponding channel slope is called strong. The corresponding water curves are denoted by B1, B2 and B3 depending on whether the curve is above the critical depth, in between the critical depth and the normal depth or below the normal depth, respectively. Water curves below the critical depth are governed by upstream boundary conditions and are called frontwater curves. Water curves above the critical depth are governed by downstream boundary conditions and are called backwater curves.

Channel flow can be supercritical or subcritical. For supercritical flow the velocity exceeds the propagation speed c of a wave, which satisfies $c = \sqrt{gh}$. Defining the Froude number by $Fr = U/c$, where U is the velocity of the fluid, supercritical flow corresponds to $Fr > 1$. Supercritical flow is controlled by upstream boundary conditions. If the flow is subcritical ($Fr < 1$) it is controlled by downstream boundary conditions. In a subcritical flow disturbances propagate upstream and downstream, in a supercritical flow they propagate downstream only. The critical depth corresponds to $U = c$. Indeed, taking a rectangular cross section the denominator of the Bresse equation is zero if

$$U^2 = gh\sqrt{1 - S_0^2}. \quad (633)$$

For frontwater curves h is less than the critical depth, consequently the velocity must exceed c (conservation of mass) and is supercritical. For backwater curves h exceeds the critical depth and the velocity is less than c , the flow is subcritical.

A transition from supercritical to subcritical flow is called a hydraulic jump, a transition from subcritical to supercritical flow is a fall. At a jump the following equation is satisfied [16]:

$$\dot{m}^2 + \rho^2 g \sqrt{1 - S_0^2} A_1^2 y_{G1} = \dot{m}^2 + \rho^2 g \sqrt{1 - S_0^2} A_2^2 y_{G2}, \quad (634)$$

where A_1, A_2 are the cross sections before and after the jump, y_{G1} and y_{G2} is the distance orthogonal to the channel floor between the fluid surface and the center of gravity of section A_1 and A_2 , respectively, ρ is the fluid density and \dot{m} is the mass flow. This relationship can be obtained by applying the conservation of momentum principle to a mass of infinitesimal width at the jump. The conservation of momentum dictates that the time rate of change of the momentum must equal all external forces. In Figure 147 a mass of width ds is shown at time t crossing a jump. At time $t + dt$ this mass is moved to the right (width ds'). The change in momentum in s-direction amounts to

$$\lim_{dt \rightarrow 0} [(\rho A_2 U_2 dt) U_2 - (\rho A_1 U_1 dt) U_1] / dt = \rho Q (U_2 - U_1). \quad (635)$$

The forces are the hydrostatic forces on the right and left side of the mass:

$$\rho g (y_{G1} \sqrt{1 - S_0^2}) A_1 - \rho g (y_{G2} \sqrt{1 - S_0^2}) A_2. \quad (636)$$

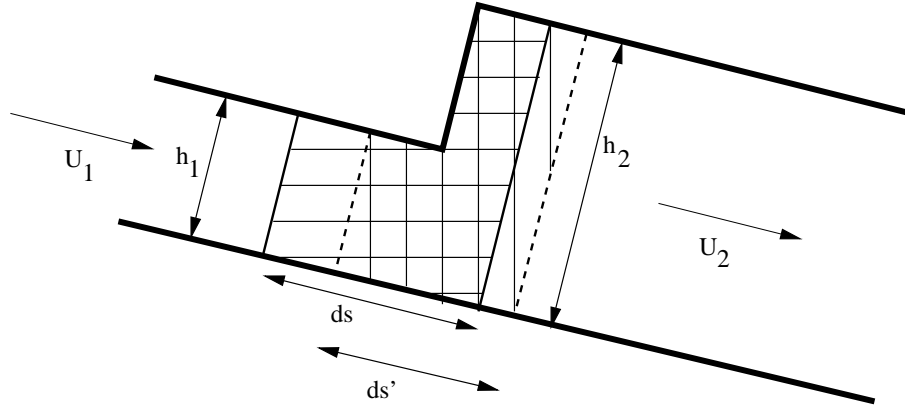

Figure 147: Conservation of momentum at a jump

All other forces such as gravity and wall friction disappear for $ds \rightarrow 0$. Equating both terms yields the jump equation. Notice that this relationship cannot be obtained by using the Bresse equation, since h is discontinuous at the jump. The discrete form of the Bernoulli equation (616) cannot be used either, since it is obtained by integrating the differential form and $dp/ds = \rho g dh/ds$ is discontinuous. However, one can write down Equation (616) pro forma and deduce the head loss in a jump by formally substituting the jump equation. One obtains:

$$\Delta F = \frac{(h_2 - h_1)^3}{4h_1h_2}. \quad (637)$$

Since the head loss must be positive, this also proves that a fall cannot occur in a prismatic channel (i.e. a channel with constant cross section). Therefore, a fall can only occur at discontinuities in the channel geometry, e.g. at a discontinuous increase of the channel floor slope S_0 .

This approach opens up an alternative to using the conservation of momentum principle at discontinuities: if one knows the head loss (e.g. by performing experiments) one can apply the discrete form of the Bernoulli equation in the form:

$$z_1 + h_1 + \frac{\dot{m}^2}{2\rho^2 A_1^2 g} = z_2 + h_2 + \frac{\dot{m}^2}{2\rho^2 A_2^2 g} + \Delta F. \quad (638)$$

Defining the specific energy E by:

$$E := h + \frac{Q^2}{2A^2 g}, \quad (639)$$

one can write the above equation as $z_1 + E_1 = z_2 + E_2 + \Delta F$, from which it is clear that the total head $z + E$ can never increase in the direction of the flow,

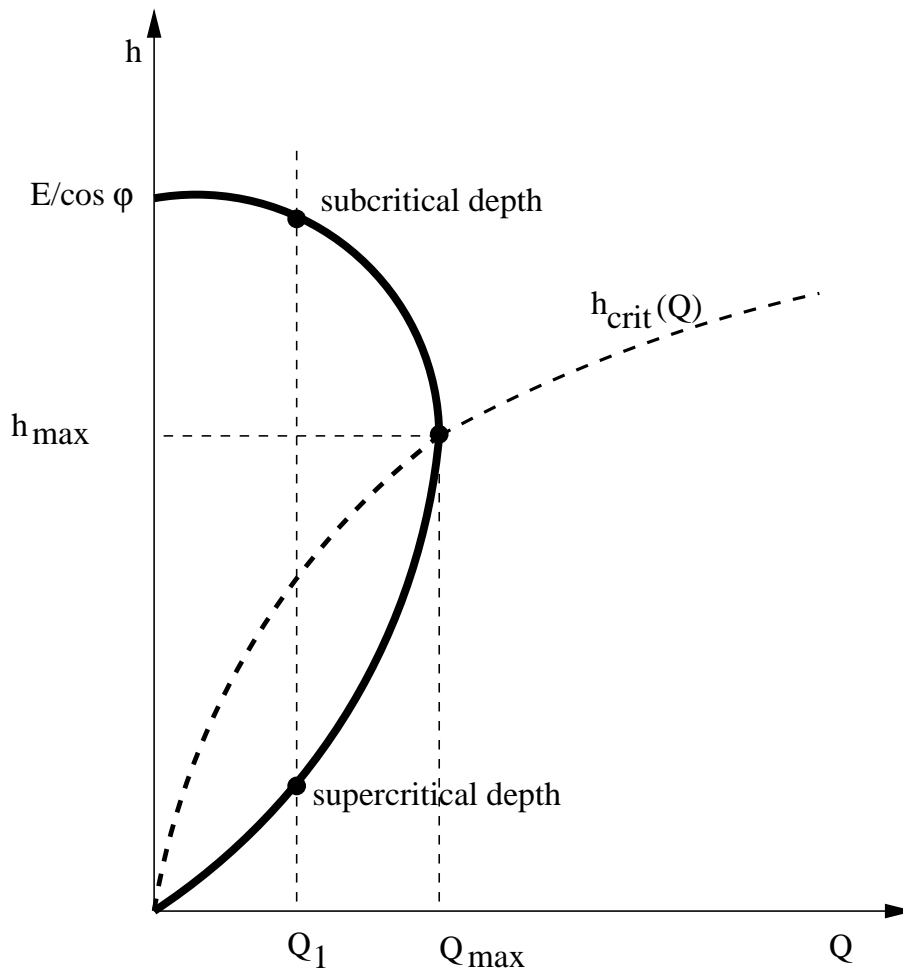

Figure 148: Allowable volumetric flow for a given specific energy

however, the specific energy can. From the definition of the specific energy one can derive the dependence of Q on h , as shown in Figure 148:

$$Q = A\sqrt{2g(E - h \cos \varphi)}. \quad (640)$$

To determine the maximum allowable volumetric flow for a given value of E one has to set the first derivative of the above equation to zero, resulting in (recall that $\partial A/\partial h = B$):

$$2B(E - h \cos \varphi) = A \cos \varphi. \quad (641)$$

Substituting this expression in Equation (640) yields:

$$Q_{max} = A\sqrt{g\frac{A \cos \varphi}{B}}, \quad (642)$$

or

$$\frac{Q_{max}^2}{gA^3B} = \cos \varphi. \quad (643)$$

This corresponds to the denominator of the Bresse equation, i.e. the depth for which the volumetric flow is maximum is the critical depth. This is illustrated in Figure 148. Curves corresponding to lower values of E also go through the origin and are completely contained in the curve shown. These curves cannot intersect, since this would mean that the intersection point corresponds to different energy values.

For a volumetric flow lower than the maximal one (Q_1 in the figure), two depths are feasible: a subcritical one and a supercritical one. The transition from a supercritical one to a subcritical corresponds to a jump. At the location of the jump $z_1 = z_2$, however, $\Delta F \neq 0$, so $E_2 < E_1$ and the subcritical height will be slightly lower than in the figure. For geometric discontinuities for which the head loss is known (e.g. for a contraction or an enlargement) the above reasoning can be used to obtain the fluid depth downstream of the discontinuity based on the specific energy upstream (or vice versa).

Available boundary conditions for channels are the sluice gate and the weir (upstream conditions) and the infinite reservoir (downstream condition). They are described in Section 6.6. Discontinuous changes within a channel can be described using the contraction, enlargement and step elements.

The elements used in CalculiX for one-dimensional channel networks are regular network elements, in which the unknowns are the fluid depth (in z -direction, i.e. not orthogonal to the channel floor) and the temperature at the end nodes and the mass flow in the middle nodes. The equations at our disposal are the Bresse equation in the middle nodes (conservation of momentum), and the mass and energy conservation (Equations 610 and 619, respectively) at the end nodes.

For channel elements the energy equation is used in its original form:

$$\sum_{j \in \text{in}} c_p(T_j)T_j \dot{m}_{ij} - c_p(T_i)T_i \sum_{j \in \text{out}} \dot{m}_{ij} + \bar{h}(T_i, T)(T - T_i) + m_i h_i^\theta = 0, \quad (644)$$

in which c_p for the incoming flow is determined at the correct upstream temperature T_j . T is the temperature of the wall. The temperatures in the network are solved for as soon as the mass flow and fluid depth have been determined in the complete network. The above equation is applied on an element by element basis starting at the upstream In/Out elements and going in downstream direction. It can be reformulated as:

$$T_i = \frac{\sum_{j \in \text{in}} c_p(T_j)T_j \dot{m}_{ij} + \bar{h}(T_i, T)T + m_i h_i^\theta}{c_p(T_i) \sum_{j \in \text{out}} \dot{m}_{ij} + \bar{h}(T_i, T)}. \quad (645)$$

This is a slightly nonlinear equation in T_i which is solved node by node in an iterative way. Convection with the wall can be defined using a *FILM card (forced convection), for the heat source *CFLUX is to be used on degree of freedom 0 (or, equivalently, 11).

Radiation to the environment can be included by modifying Equation (644) into:

$$\begin{aligned} \sum_{j \in \text{in}} c_p(T_j)T_j \dot{m}_{ij} - c_p(T_i)T_i \sum_{j \in \text{out}} \dot{m}_{ij} + \bar{h}(T_i, T)(T - T_i) \\ + \epsilon(T_i)\sigma A(T^4 - T_i^4) + m_i h_i^\theta = 0, \end{aligned} \quad (646)$$

where A is the representative radiating surface for T_i , ϵ is the emissivity, σ is the Stefan-Boltzmann constant and all temperatures have to be on an absolute scale. The radiating surface can be modeled using shell elements or solid elements covering the fluid surface. The above equation is a quartic equation, which can be solved using the conventional Newton-Raphson technique. Due to the independent processing of the energy equation after having solved the mass and momentum equation it is assumed that a change in temperature does not significantly influence the flow conditions.

Output variables are the mass flow (key MF on the *NODE PRINT or *NODE FILE card), the fluid depth (key PN — network pressure — on the *NODE PRINT card and DEPT on the *NODE FILE card) and the total temperature (key NT on the *NODE PRINT card and TT on the *NODE FILE card). These are the primary variables in the network. Internally, in network nodes, components one to three of the structural displacement field are used for the mass flow, the fluid depth and the critical depth, respectively. So their output can also be obtained by requesting U on the *NODE PRINT card. This is the only way to get the critical depth in the .dat file. In the .frd file the critical depth can be obtained by selecting HCRI on the *NODE FILE card. Notice that for liquids the total temperature virtually coincides with the static temperature (cf. previous section; recall that the wave speed in a channel with

water depth 1 m is $\sqrt{10}$ m/s). If a jump occurs in the network, this is reported on the screen listing the element in which the jump takes place and its relative location within the element.

6.9.19 Three-dimensional Navier-Stokes Calculations

The solution of the three-dimensional Navier-Stokes equations has been implemented following the Characteristic Based Split (CBS) Method of Zienkiewicz and co-workers [110],[107]. The present implementation does include laminar and turbulent calculations for compressible and incompressible fluids. The calculations are transient, however, they are pursued up to steady state or up to the number of iterations specified by the user.

The input deck format for CFD-calculations is very similar to structural calculations. Noticable differences are:

- boundary conditions are specified by the *BOUNDARY card. The velocity degrees of freedom are labeled 1 up to 3, the thermal degree is 11 and the pressure degree is 8.
- the maximum number of iterations is specified by the INCF parameter on the *STEP card. The writing frequency on e.g. the *NODE FILE card is specified by the FREQUENCYF parameter.

For incompressible flows the following additional comments are due:

- thermal calculations do not influence the velocity and the pressure field. A calculation is considered thermal if initial conditions have been specified for the temperature.
- the material properties are introduced by the *DENSITY and the *FLUID CONSTANTS card. In case temperatures are to be calculated the *CONDUCTIVITY card is needed.

For compressible flows the following additional information is needed:

- for compressible flow the temperature is strongly linked to the velocity and the pressure. Therefore, initial conditions for all these fields are needed.
- the *CONDUCTIVITY and *SPECIFIC GAS CONSTANT card underneath the *MATERIAL card are required, the *DENSITY card must not be used.
- the *PHYSICAL CONSTANTS card is required for the definition of absolute zero
- the *VALUES AT INFINITY card is needed for the calculation of C_p and for the turbulence models.
- the *SHOCK SMOOTHING parameter on the *STEP card may be needed to obtain convergence (only for explicit calculations).

- the COMPRESSIBLE parameter on the *STATIC card is required.

Fluid problems are of a quite different nature than structural problems. What we particularly noticed in fluid problems is that

- The solution can be mesh dependent, i.e. the fluid flow sometimes follows the element edges although this may be wrong. This is particularly true for coarse meshes.
- Coarse meshes may produce a solution which is completely wrong. Taking this solution as starting point for gradually finer meshes frequently leads to the right solution.
- If the boundaries of the mesh are too close to the area of interest the solution may not be unique. For instance, turbulent flow may lead to an undefined reentry at the exit of your mesh. Consequently, the boundaries of your mesh must be far enough away.

The basic idea of the CBS method is to formulate the governing equation in a coordinate system moving with the characteristics of the flow, leading to a disappearance of the convective first order terms. To illustrate this, we start from a one-dimensional equation in the non-conservative form (the velocity v is brought outside the partial differentiation)

$$\frac{\partial \phi}{\partial t} + v \frac{\partial \phi}{\partial x} - \frac{\partial}{\partial x} \left(\kappa \frac{\partial \phi}{\partial x} \right) - Q = 0, \quad (647)$$

exhibiting a transient, convective, diffusive and source term (ϕ is some dependent quantity such as temperature). Applying a change of variables from x to x' :

$$dx' = dx - v dt, \quad (648)$$

where x' moves with the fluid, this equation is transformed into:

$$\frac{\partial \phi}{\partial t}(x'(t), t) - \frac{\partial}{\partial x'} \left(\kappa \frac{\partial \phi}{\partial x'} \right) - Q(x') = 0, \quad (649)$$

i.e. the convective term disappears.

Applying Finite Differences along the characteristic from time t (superindex n) to time $t + \Delta t$ (superindex $n+1$) leads to (Figure 149):

$$\begin{aligned} \frac{1}{\Delta t} (\phi^{n+1} - \phi^n|_{x-\delta}) \approx & \theta \left[\frac{\partial}{\partial x} \left(\kappa \frac{\partial \phi}{\partial x} \right) + Q \right]^{n+1} \Big|_x \\ & + (1 - \theta) \left[\frac{\partial}{\partial x} \left(\kappa \frac{\partial \phi}{\partial x} \right) + Q \right]^n \Big|_{x-\delta}, \end{aligned} \quad (650)$$

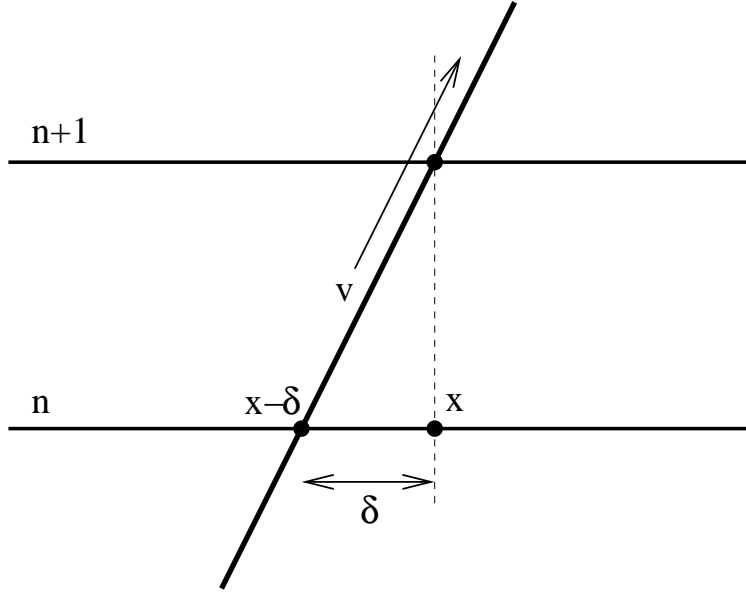

Figure 149: Formulating the equations along characteristics

where θ takes a value between 0 and 1. Now, by applying a Taylor series expansion the values at $x - \delta$ can be written as a function of values at x :

$$\phi^n|_{x-\delta} = \phi^n|_x - \delta \left. \frac{\partial \phi^n}{\partial x} \right|_x + \frac{\delta^2}{2} \left. \frac{\partial^2 \phi^n}{\partial x^2} \right|_x + O(\delta^3), \quad (651)$$

$$\left. \frac{\partial}{\partial x} \left(\kappa \frac{\partial \phi}{\partial x} \right)^n \right|_{x-\delta} = \left. \frac{\partial}{\partial x} \left(\kappa \frac{\partial \phi}{\partial x} \right)^n \right|_x - \delta \left. \frac{\partial}{\partial x} \left[\frac{\partial}{\partial x} \left(\kappa \frac{\partial \phi}{\partial x} \right)^n \right] \right|_x + O(\delta^2), \quad (652)$$

and

$$Q^n|_{x-\delta} = Q^n|_x - \delta \left. \frac{\partial Q^n}{\partial x} \right|_x + O(\delta^2). \quad (653)$$

Therefore, Equation (650) now yields (from now on the subindex x is dropped to simplify the notation):

$$\begin{aligned} \frac{1}{\Delta t} (\phi^{n+1} - \phi^n + \delta \frac{\partial \phi^n}{\partial x} - \frac{\delta^2}{2} \frac{\partial^2 \phi^n}{\partial x^2}) &\approx \theta \left[\frac{\partial}{\partial x} \left(\kappa \frac{\partial \phi}{\partial x} \right) + Q \right]^{n+1} \\ &+ (1 - \theta) \left[\frac{\partial}{\partial x} \left(\kappa \frac{\partial \phi}{\partial x} \right)^n - \delta \frac{\partial}{\partial x} \left[\frac{\partial}{\partial x} \left(\kappa \frac{\partial \phi}{\partial x} \right)^n \right] \right] \\ &+ (1 - \theta) \left[Q^n - \delta \frac{\partial Q^n}{\partial x} \right] \end{aligned} \quad (654)$$

Now, $\delta = \bar{v}\Delta t$, where \bar{v} can be approximated by:

$$\bar{v} \approx \frac{1}{2} (v^{n+1} + v^n|_{x-\delta}). \quad (655)$$

Since

$$v^n|_{x-\delta} = v^n - \delta \frac{\partial v^n}{\partial x} + O(\delta^2) \quad (656)$$

one obtains:

$$\begin{aligned} \bar{v} &= \frac{1}{2}(v^{n+1} + v^n) - \frac{\delta}{2} \frac{\partial v^n}{\partial x} + O(\Delta t^2) \\ &= v^{n+1/2} - \left(\frac{\bar{v}\Delta t}{2}\right) \frac{\partial v^n}{\partial x} + O(\Delta t^2) \\ &= v^{n+1/2} - \left(\frac{v^{n+1/2}\Delta t}{2}\right) \frac{\partial v^n}{\partial x} + O(\Delta t^2), \end{aligned} \quad (657)$$

where

$$v^{n+1/2} := \frac{1}{2}(v^{n+1} + v^n) \quad (658)$$

was defined. Consequently:

$$\delta = v^{n+1/2}\Delta t - \left(\frac{v^{n+1/2}\Delta t^2}{2}\right) \frac{\partial v^n}{\partial x} + O(\Delta t^3). \quad (659)$$

Substituting this in Equation (654) and setting $\theta = 1/2$ leads to:

$$\begin{aligned} \frac{1}{\Delta t}(\phi^{n+1} - \phi^n) &= -\frac{1}{\Delta t} \left[v^{n+1/2}\Delta t - \frac{v^{n+1/2}}{2}\Delta t^2 \frac{\partial v^n}{\partial x} + O(\Delta t^3) \right] \frac{\partial \phi^n}{\partial x} \\ &\quad + \frac{1}{2\Delta t} \left[(v^{n+1/2})^2 \Delta t^2 + O(\Delta t^3) \right] \frac{\partial^2 \phi^n}{\partial x^2} \\ &\quad + \frac{1}{2} \left[\frac{\partial}{\partial x} \left(\kappa \frac{\partial \phi}{\partial x} \right) + Q \right]^{n+1} \\ &\quad + \frac{1}{2} \left[\frac{\partial}{\partial x} \left(\kappa \frac{\partial \phi}{\partial x} \right) + Q \right]^n \\ &\quad - \frac{\Delta t}{2} v^{n+1/2} \frac{\partial}{\partial x} \left[\frac{\partial}{\partial x} \left(\kappa \frac{\partial \phi}{\partial x} \right) \right]^n + O(\Delta t^2) \\ &\quad - \frac{\Delta t}{2} v^{n+1/2} \frac{\partial Q^n}{\partial x} + O(\Delta t^2). \end{aligned} \quad (660)$$

Since

$$v^{n+1/2} = v^n + \frac{\partial v^n}{\partial t} \Delta t/2 + O(\Delta t^2), \quad (661)$$

v^n in the first line of Equation (660) can be replaced by $v^{n+1/2}$ without loss of accuracy. Therefore, the terms quadratic in Δt in the first two lines can be merged into:

$$v^{n+1/2} \frac{\Delta t^2}{2} \Delta t^2 \frac{\partial v^{n+1/2}}{\partial x} \frac{\partial \phi}{\partial x} + (v^{n+1/2})^2 \frac{\Delta t^2}{2} \frac{\partial^2 \phi}{\partial x^2} = v^{n+1/2} \frac{\Delta t^2}{2} \frac{\partial}{\partial x} \left(v^{n+1/2} \frac{\partial \phi}{\partial x} \right), \quad (662)$$

and one now obtains:

$$\begin{aligned} (\phi^{n+1} - \phi^n) = & -\Delta t \left\{ v^{n+1/2} \frac{\partial \phi^n}{\partial x} - \left[\frac{\partial}{\partial x} \left(\kappa \frac{\partial \phi}{\partial x} \right) + Q \right]^{n+1/2} \right\} \\ & + \frac{\Delta t^2}{2} v^{n+1/2} \frac{\partial}{\partial x} \left[v^{n+1/2} \frac{\partial \phi}{\partial x} - \frac{\partial}{\partial x} \left(\kappa \frac{\partial \phi}{\partial x} \right) - Q \right]^n + O(\Delta t^3). \end{aligned} \quad (663)$$

In the last equation $v^{n+1/2}$ can be replaced by an extrapolation of v at time $t_n + \Delta t/2$ based on its values in iteration $n-1$ and n without loss of accuracy. Indeed, combining

$$v^{n+1/2} = v^n + \frac{\partial v^n}{\partial t} \frac{\Delta t_n}{2} + O(\Delta t_n^2), \quad (664)$$

($\Delta t_n := t_{n+1} - t_n$) and

$$v^{n-1} = v^n - \frac{\partial v^n}{\partial t} \Delta t_{n-1} + O(\Delta t_{n-1}^2), \quad (665)$$

($\Delta t_{n-1} := t_n - t_{n-1}$) or, equivalently,

$$\frac{\partial v^n}{\partial t} = \frac{v_n - v_{n-1}}{\Delta t_{n-1}} + O(\Delta t_{n-1}), \quad (666)$$

one obtains

$$v^{n+1/2} = v^n + \frac{v^n - v^{n-1}}{\Delta t_{n-1}} \left(\frac{\Delta t_n}{2} \right) + O(\Delta t_n \Delta t_{n-1}) + O(\Delta t_n^2), \quad (667)$$

or for $\Delta t_{n-1} = \Delta t_n = \Delta t$:

$$v^{n+1/2} = v^n + \frac{v^n - v^{n-1}}{2} + O(\Delta t^2). \quad (668)$$

In the same way the diffusive and source terms at time $t_{n+1/2}$ are evaluated based on a similar extrapolation of the velocity and temperature (for the momentum and energy equation, respectively).

Generalizing Equation (663) to three dimensions and writing the equation in conservative form (i.e. replacing $v^{n+1/2} \partial \phi / \partial x$ by $\partial v^{n+1/2} \phi / \partial x$) finally yields:

$$\begin{aligned}
(\phi^{n+1} - \phi^n) \approx & -\Delta t \left\{ \frac{\partial(v_j^{n+1/2} \phi^n)}{\partial x_j} - \left[\frac{\partial}{\partial x_j} \left(\kappa \frac{\partial \phi}{\partial x_j} \right) + Q \right]^{n+1/2} \right\} \\
& + \frac{\Delta t^2}{2} v_k^{n+1/2} \frac{\partial}{\partial x_k} \left[\frac{\partial(v_j^{n+1/2} \phi)}{\partial x_j} - \frac{\partial}{\partial x_j} \left(\kappa \frac{\partial \phi}{\partial x_j} \right) - Q \right]^n. \quad (669)
\end{aligned}$$

The last three terms can be viewed as stabilization terms. Usually, only terms up to the second order derivative are taken into account. Therefore, the stabilization term for the diffusion is usually neglected.

The corresponding weak formulation is obtained by multiplying the above equation with the shape function φ_α for a concrete node and integrating over the volume. Therefore, the CBS Method transforms a transport equation of the form

$$\frac{\partial C}{\partial t} = -(v_k C)_{,k} + D_{k,k} + F, \quad (670)$$

where C stands for the convective term, D for the diffusion term and F for the source term, into

$$\begin{aligned}
\sum_{\beta} \left[\int_V \varphi_\alpha \varphi_\beta dV \right] \Delta C_\beta = & -\Delta t \int_V \varphi_\alpha \left[\sum_{\beta} (v_k^{n+1/2} \varphi_\beta)_{,k} C_\beta^n \right] dV \\
& - \Delta t \int_V \varphi_{\alpha,k} D_k^{n+1/2} dV \\
& + \Delta t \int_V \varphi_\alpha F^{n+1/2} dV \\
& - \frac{\Delta t^2}{2} \int_V (\varphi_\alpha v_l^{n+1/2})_{,l} \left[\sum_{\beta} (v_k^{n+1/2} \varphi_\beta)_{,k} C_\beta^n \right] dV \\
& + \Delta t \int_A \varphi_\alpha D_k^{n+1/2} n_k dA \\
& + \frac{\Delta t^2}{2} \int_V (\varphi_\alpha v_l^{n+1/2})_{,l} F^n dV. \quad (671)
\end{aligned}$$

Notice that the integral over the total volume in reality is a sum of the integrals over each element. For each element the local shape functions are used in expressions such as $C = \sum_{\beta} \varphi_\beta C_\beta$.

The first, second and third term on the right hand side correspond to convection, diffusion and external forces, respectively. The fourth and sixth terms are the stabilization terms for convection and external forces, while the fifth term is the area term corresponding to diffusion. It is the result of partial integration. The stabilization terms were obtained through partial integration

too. In agreement with the CBS Method the corresponding area terms are neglected. Furthermore, third-order and higher order terms are neglected as well (particularly the stabilization terms corresponding to diffusion).

This method is now applied to the transport equations for mass, momentum and energy. Furthermore, the resulting momentum equation is split into two parts (Split scheme A in [110]), one part of which is calculated at the beginning of the iteration scheme. Subsequently, the conservation of mass equation is solved, followed by the second part of the momentum equation. To this end the correction to the momentum $\Delta V_k = \rho \Delta v_k$ in direction k is written as a sum of two corrections:

$$\Delta V_k = \Delta V_k^* + \Delta V_k^{**}. \quad (672)$$

This results in the following steps:

Step 1: Conservation of Momentum (first part)

The partial differential equation reads:

$$\frac{\partial V_i}{\partial t} = -\frac{\partial}{\partial x_k}(v_k V_i) + \frac{\partial t_{ik}}{\partial x_k} - \frac{\partial p}{\partial x_i} + \rho g_i. \quad (673)$$

Applying the CBS method to all terms except the pressure term leads to:

$$\begin{aligned} \sum_{\beta} \left[\int_V \varphi_{\alpha} \varphi_{\beta} dV \right] \Delta V_{\beta i}^* = & -\Delta t \int_V \varphi_{\alpha} \left[\sum_{\beta} (v_k^{n+1/2} \varphi_{\beta})_{,k} V_{\beta i}^n \right] dV \\ & -\Delta t \int_V \varphi_{\alpha,k} (t_{ik} + t_{ik}^R)^{n+1/2} dV \\ & +\Delta t \int_V \varphi_{\alpha} \rho g_i^{n+1/2} dV \\ & -\frac{\Delta t^2}{2} \int_V (\varphi_{\alpha} v_l^{n+1/2})_{,l} \left[\sum_{\beta} (v_k^{n+1/2} \varphi_{\beta})_{,k} V_{\beta i}^n \right] dV \\ & +\frac{\Delta t^2}{2} \int_V (\varphi_{\alpha} v_l^{n+1/2})_{,l} \rho g_i^n dV \\ & +\Delta t \int_A \varphi_{\alpha} (t_{ik} + t_{ik}^R)^{n+1/2} n_k dA. \end{aligned} \quad (674)$$

V_i is the momentum, t_{ik} is the diffusive stress and t_{ik}^R is the Reynolds stress multiplied by ρ (only for turbulent flow), all evaluated at time t . g_i is the gravity acceleration at time $t + \Delta t$. The diffusive stress satisfies

$$t_{ik} = \mu(v_{i,k} + v_{k,i} - \frac{2}{3}v_{m,m}\delta_{ik}) \quad (675)$$

whereas t_{ik}^R is defined by

$$t_{ik}^R = \mu_t(v_{i,k} + v_{k,i} - \frac{2}{3}v_{m,m}\delta_{ik}) - \frac{2}{3}\rho k\delta_{ik}. \quad (676)$$

Here, μ_t is the turbulent viscosity and k is the turbulent kinetic energy. What is lacking in equation (674) to be equivalent to the momentum transport equation is the pressure term.

Step 2: Conservation of mass

The partial differential equation reads:

$$\frac{\partial \rho}{\partial t} = -\frac{\partial V_i}{\partial x_i} \quad (677)$$

This can be approximated by:

$$\frac{\Delta \rho}{\Delta t} \approx -\frac{\partial V_i^n}{\partial x_i} - \theta_1 \frac{\partial \Delta V_i^*}{\partial x_i} - \theta_1 \frac{\partial \Delta V_i^{**}}{\partial x_i}, \quad (678)$$

where θ_1 is a parameter leading to an explicit scheme for $\theta_1 = 0$ and an implicit scheme for $\theta_1 = 1$. Now, for ΔV_i^{**} one can use the gradient of the pressure in the momentum equation (this term can be treated in a way similar to a source term):

$$\Delta V_i^{**} \approx -\Delta t \left(\frac{\partial p}{\partial x_i} \right)^{n+1/2} + \frac{\Delta t^2}{2} v_k^{n+1/2} \frac{\partial}{\partial x_k} \left(\frac{\partial p}{\partial x_i} \right)^n. \quad (679)$$

Before substituting Equation (679) into Equation (678) the stabilization term is dropped (leads to a third order derivative) and the pressure gradient at $n + 1/2$ is changed into a gradient in between n and $n + 1$ by use of a parameter θ_2 (θ_2 is equivalent to θ in Equation(654):

$$\Delta V_i^{**} \approx -\Delta t \left(\frac{\partial p}{\partial x_i} \right)^n - \theta_2 \Delta t \frac{\partial \Delta p}{\partial x_i}. \quad (680)$$

For $\theta_2 = 0$ one obtains an explicit scheme (used for compressible media), for $\theta_2 = 1$ an implicit scheme (used for incompressible media). Now one obtains for Equation (678):

$$\frac{\Delta \rho}{\Delta t} \approx -\frac{\partial V_i^n}{\partial x_i} - \theta_1 \frac{\partial \Delta V_i^*}{\partial x_i} + \theta_1 \Delta t \left[\frac{\partial^2 p}{\partial x_i \partial x_i} \right]^n + \theta_2 \frac{\partial^2 \Delta p}{\partial x_i \partial x_i}. \quad (681)$$

Applying Galerkin and partial integration to all terms on the right, this leads to:

$$\begin{aligned}
& \sum_{\beta} \left[\int_V \varphi_{\alpha} \varphi_{\beta} dV \right] \Delta \rho_{\beta} + \theta_1 \theta_2 (\Delta t)^2 \sum_{\beta} \left[\int_V \varphi_{\alpha, i} \varphi_{\beta, i} dV \right] \Delta p_{\beta} \\
&= \Delta t \int_V \varphi_{\alpha, i} \left[\sum_{\beta} \varphi_{\beta} V_{\beta i}^n \right] dV \\
&+ \theta_1 \Delta t \int_V \varphi_{\alpha, i} \left[\sum_{\beta} \varphi_{\beta} \Delta V_{\beta i}^* \right] dV \\
&- \theta_1 (\Delta t)^2 \int_V \varphi_{\alpha, i} \left[\sum_{\beta} \varphi_{\beta, i} p_{\beta}^n \right] dV \\
&- \Delta t \int_A \varphi_{\alpha} V_i^n n_i dA. \tag{682}
\end{aligned}$$

In agreement with [107] the following approximation was made:

$$\Delta t \int_A \varphi_{\alpha} [V_i^n + \theta_1 (\Delta V_i^* + \Delta V_i^{**})] n_i dA \approx \Delta t \int_A \varphi_{\alpha} V_i^n n_i dA, \tag{683}$$

leading to the last term in equation (682). The velocity in the mass conservation equation is calculated at time $t + \theta_1 \Delta t$, whereas the pressure in the momentum transport equation is expressed at time $t + \theta_2 \Delta t$ ($0 \leq \theta_1, \theta_2 \leq 1$). If $\theta_2 = 0$ the scheme is called explicit, else it is semi-implicit (in the latter case it is not fully implicit, since the diffusion term in the momentum equation is still expressed at time t). For compressible fluids (gas) an explicit scheme is taken. This means that the second term on the left hand side of equation (682) disappears and the only unknowns are $\Delta \rho_{\beta}$. For incompressible fluids the density is constant and consequently the first term is zero: the unknowns are now the pressure terms Δp_{β} .

An additional difference between compressible and incompressible fluids is that the left hand side of equation (682) for incompressible fluids (liquids) is usually not lumped: a regular sparse linear equation solver is used. For compressible fluids it is lumped, leading to a diagonal matrix. Lumping is also applied to all other equations (momentum, energy..), irrespective whether the fluid is a liquid or not.

Step 3: Conservation of Momentum (second part)

This equation takes care of the pressure term in the momentum equation, which was not covered by step 1. Now, the terms are evaluated at $n + \theta_2$:

$$\Delta V_i^{**} \approx -\Delta t \left(\frac{\partial p}{\partial x_i} \right)^n - \theta_2 \Delta t \frac{\partial \Delta p}{\partial x_i} + (1 - \theta_2) \Delta t^2 v_k^{n+1/2} \frac{\partial}{\partial x_k} \left(\frac{\partial p}{\partial x_i} \right)^n. \tag{684}$$

In weak form this leads to (applying partial integration to the stabilization term):

$$\begin{aligned} \sum_{\beta} \left[\int_V \varphi_{\alpha} \varphi_{\beta} dV \right] \Delta V_{\beta i}^{**} &= - \Delta t \int_V \varphi_{\alpha} \left[\sum_{\beta} \varphi_{\beta, i} p_{\beta} \right] dV \\ &\quad - \theta_2 \Delta t \int_V \varphi_{\alpha} \left[\sum_{\beta} \varphi_{\beta, i} \Delta p_{\beta} \right] dV \\ &\quad - (1 - \theta_2) \Delta t^2 \int_V (\varphi_{\alpha} v_k)_{,k} \left[\sum_{\beta} \varphi_{\beta, i} p_{\beta} \right] dV. \end{aligned} \quad (685)$$

Notice that for compressible fluids the second term on the right hand side disappears ($\theta_2 = 0$). Consequently, Δp is not needed for gases. This is good news, since only $\Delta \rho$ is known at this point (conservation of mass).

Step 4: Conservation of Energy

The governing differential equation runs:

$$\frac{\partial \rho \varepsilon_t}{\partial t} = -[v_k(\rho \varepsilon_t + p)]_{,k} + [t_{km} v_m + \kappa T_{,k}]_{,k} + [\rho f_k v_k + \rho h^{\theta}], \quad (686)$$

where ε_t is the total internal energy per unit of volume, κ is the conduction coefficient, f_k are the external forces and h^{θ} represents volumetric heat sources. ε_t satisfies

$$\varepsilon_t = \varepsilon + (v_i v_i)/2. \quad (687)$$

The energy equation in the above form can be directly obtained from Equation (36). Indeed, the right hand side in both equations is identical. The left hand side of Equation (36) can be written as:

$$\rho \frac{D\varepsilon_t}{Dt} = \frac{D(\rho \varepsilon_t)}{Dt} + \varepsilon_t \rho v_{k,k} = \frac{\partial \rho \varepsilon_t}{\partial t} + (\rho \varepsilon_t)_{,k} v_k + \varepsilon_t \rho v_{k,k} = \frac{\partial \rho \varepsilon_t}{\partial t} + (\rho \varepsilon_t v_k)_{,k} \quad (688)$$

in which the conservation of mass was used in the form

$$\frac{D\rho}{Dt} = \frac{\partial \rho}{\partial t} + \rho_{,k} v_k = -\rho v_{k,k}. \quad (689)$$

Straightforward application of the CBS method yields

$$\begin{aligned}
\sum_{\beta} \left[\int_V \varphi_{\alpha} \varphi_{\beta} dV \right] (\Delta \rho \varepsilon_t)_{\beta} = & - \Delta t \int_V \varphi_{\alpha} \left[\sum_{\beta} (v_k^{n+1/2} \varphi_{\beta})_{,k} (\rho \varepsilon_t + p)_{\beta}^n \right] dV \\
& - \Delta t \int_V \varphi_{\alpha,k} (t_{km} v_m + \kappa T_{,k})^{n+1/2} dV \\
& + \Delta t \int_V \varphi_{\alpha} [\rho f_k v_k + \rho h^{\theta}]^{n+1/2} dV \\
& - \frac{\Delta t^2}{2} \int_V (\varphi_{\alpha} v_l^{n+1/2})_{,l} \left[\sum_{\beta} (v_k^{n+1/2} \varphi_{\beta})_{,k} (\rho \varepsilon_t + p)_{\beta}^n \right] dV \\
& + \frac{\Delta t^2}{2} \int_V (\varphi_{\alpha} v_l^{n+1/2})_{,l} [\rho f_k v_k + \rho h^{\theta}]^n dV \\
& + \Delta t \int_A \varphi_{\alpha} (t_{km} v_m + \kappa T_{,k})^{n+1/2} n_k dA. \quad (690)
\end{aligned}$$

If a heat flux boundary condition \mathbf{q} is specified the term $\kappa \nabla T$ is replaced by \mathbf{q} . Furthermore, for turbulent flows t_{km} is replaced by $t_{km} + t_{km}^R$ and κ by $\kappa + c_p \mu_t / \text{Pr}_t$, where Pr_t is the turbulent Prandtl number (for air $\text{Pr}_t = 0.9$). For liquids the energy equation is uncoupled from the other equations, unless the temperature leads to motion due to differences in the density (buoyancy). For gases, however, there is a strong coupling with the other equations through the equation of state:

$$p = \rho r T, \quad (691)$$

where r is the specific gas constant.

Step 5: Turbulence

The turbulence implementation closely follows the equations in [57]. There are basically two extra variables: the turbulent kinetic energy k and the turbulence frequency ω . The governing differential equations read

$$\frac{\partial \rho k}{\partial t} = -[v_k(\rho k)]_{,k} + [(\mu + \sigma_k \rho \nu_t)k]_{,k} + (t_{ij}^R u_{i,j} - \beta^* \rho \omega k) \quad (692)$$

and

$$\frac{\partial \rho \omega}{\partial t} = -[v_k(\rho \omega)]_{,k} + [(\mu + \sigma_{\omega} \rho \nu_t)\omega]_{,k} + \left(\frac{\gamma}{\nu_t} t_{ij}^R u_{i,j} - \beta \rho \omega^2 + \frac{2}{\omega} (1 - F_1) \rho \sigma_{\omega 2} k_{,j} \omega_{,j} \right). \quad (693)$$

For the meaning of the constants the reader is referred to Menter [57]. The turbulence equations are in a standard form clearly showing the convective,

diffusive and source terms. Consequently, application of the CBS scheme is straightforward:

$$\begin{aligned}
\sum_{\beta} \left[\int_V \varphi_{\alpha} \varphi_{\beta} dV \right] (\Delta \rho k)_{\beta} &= -\Delta t \int_V \varphi_{\alpha} \left[\sum_{\beta} (v_k^{n+1/2} \varphi_{\beta})_{,k} (\rho k)_{\beta}^n \right] dV \\
&\quad - \Delta t \int_V \varphi_{\alpha,k} (\mu + \sigma_k \rho \nu_t) k_{,k}^{n+1/2} dV \\
&\quad + \Delta t \int_V \varphi_{\alpha} [t_{ij}^R u_{i,j} - \beta^* \rho \omega k]^{n+1/2} dV \\
&\quad - \frac{\Delta t^2}{2} \int_V (\varphi_{\alpha} v_l^{n+1/2})_{,l} \left[\sum_{\beta} (v_k^{n+1/2} \varphi_{\beta})_{,k} (\rho k)_{\beta}^n \right] dV \\
&\quad + \frac{\Delta t^2}{2} \int_V (\varphi_{\alpha} v_l^{n+1/2})_{,l} [t_{ij}^R u_{i,j} - \beta^* \rho \omega k]^n dV \\
&\quad + \Delta t \int_A \varphi_{\alpha} (\mu + \sigma_k \rho \nu_t) k_{,k}^{n+1/2} n_k dA. \tag{694}
\end{aligned}$$

$$\begin{aligned}
\sum_{\beta} \left[\int_V \varphi_{\alpha} \varphi_{\beta} dV \right] (\Delta \rho \omega)_{\beta} &= -\Delta t \int_V \varphi_{\alpha} \left[\sum_{\beta} (v_k^{n+1/2} \varphi_{\beta})_{,k} (\rho \omega)_{\beta}^n \right] dV \\
&\quad - \Delta t \int_V \varphi_{\alpha,k} (\mu + \sigma_{\omega} \rho \nu_t) \omega_{,k}^{n+1/2} dV \\
&\quad + \Delta t \int_V \varphi_{\alpha} \left[\frac{\gamma}{\nu_t} t_{ij}^R u_{i,j} - \beta \rho \omega^2 \right. \\
&\quad \left. + \frac{2}{\omega} (1 - F_1) \rho \sigma_{\omega 2} k_{,j} \omega_{,j} \right]^{n+1/2} dV \\
&\quad - \frac{\Delta t^2}{2} \int_V (\varphi_{\alpha} v_l^{n+1/2})_{,l} \left[\sum_{\beta} (v_k^{n+1/2} \varphi_{\beta})_{,k} (\rho \omega)_{\beta}^n \right] dV \\
&\quad + \frac{\Delta t^2}{2} \int_V (\varphi_{\alpha} v_l^{n+1/2})_{,l} \left[\frac{\gamma}{\nu_t} t_{ij}^R u_{i,j} - \beta \rho \omega^2 \right. \\
&\quad \left. + \frac{2}{\omega} (1 - F_1) \rho \sigma_{\omega 2} k_{,j} \omega_{,j} \right]^n dV \\
&\quad + \Delta t \int_A \varphi_{\alpha} (\mu + \sigma_{\omega} \rho \nu_t) \omega_{,k}^{n+1/2} n_k dA. \tag{695}
\end{aligned}$$

The above equations were slightly modified according to [98] in order to avoid a non-physical decay of the turbulence variables at the freestream boundary conditions. To this end the terms $-\beta^* \rho \omega k$ and $-\beta \rho \omega^2$ were replaced by $-\beta^* \rho \omega k + \beta^* \rho \omega_{\text{free}} k_{\text{free}}$ and $-\beta \rho \omega^2 + \beta \rho \omega_{\text{free}}^2$, respectively, where the subscript “free” denotes the freestream values.

Turbulent equations require the definition of the nodal set SOLIDSURFACE containing all nodes belonging to a solid surface and the nodal set FREESTREAMSURFACE containing all nodes belonging to free stream conditions such as inlet and outlet. For each of these surfaces CalculiX assigns specific boundary conditions to the turbulence parameters k and ω according to the publication by Menter.

Note that the conservative variables ρk and $\rho \omega$ should always be positive. Therefore, when the calculated change of these variables in each increment is added to their previous values only if the sum of both is positive, else the change is set to zero for that increment.

Notice that the unknowns in the systems of equations in all steps are the conservative variables V_i , ρ (or p for liquids) and $\rho \varepsilon_t$. The physical variables the user usually knows and for which boundary conditions exist are v_i , p and T . So at the start of the calculation the initial physical values are converted into conservative variables, and within each iteration the newly calculated conservative variables are converted into physical ones, in order to be able to apply the boundary conditions.

The conversion of conservative variables into physical ones can be obtained using the following equations for gases:

$$T = \frac{1}{\rho(c_p(T) - r)} \left[\rho \varepsilon_t - \frac{V_i V_i}{2\rho} \right], \quad (696)$$

$$v_i = V_i / \rho, \quad (697)$$

and $p = \rho r T$. For liquids ρ is a function of the temperature T and the first equation has to be replaced by

$$T = \frac{1}{\rho(T)c_p(T)} \left[\rho(T)\varepsilon_t - \frac{V_i V_i}{2\rho(T)} \right], \quad (698)$$

since $c_v = c_p$. T in all equations above is the static temperature on an absolute scale. For gases the total temperature and Mach number can be calculated by:

$$T_t = T + V_i V_i / (2c_p) \quad (699)$$

and

$$M = \sqrt{\frac{v_i v_i}{\gamma r T}} \quad (700)$$

where $\gamma = c_p / c_v$. Notice that the equations for the static temperature are nonlinear equations which have to be solved in an iterative way, e.g. by the Newton-Raphson procedure.

The semi-implicit procedure for fluids and the explicit procedure for liquids are conditionally stable. For each node i a maximum time increment Δt_i can be determined. For the semi-implicit procedure it obeys:

$$\Delta t_i = \min \left\{ \frac{h_i}{\sqrt{v_i v_i}}, \frac{\rho_i h_i^2}{2\mu(T_i)}, \frac{\rho_i h_i^2 Pr_i(T_i)}{2\mu_i(T_i)} \right\}, \quad (701)$$

where

$$Pr_i = \frac{\mu(T_i) c_p(T_i)}{\kappa(T_i)} \quad (702)$$

is the Prandtl number, and for the explicit procedure it reads

$$\Delta t_i = \frac{h_i}{c_i + \sqrt{v_i v_i}}, \quad (703)$$

where

$$c_i = \sqrt{\frac{c_p(T_i) r T_i}{c_p(T_i) - r}} \quad (704)$$

is the speed of sound. In the above equations h_i is the smallest distance from node i to all neighboring nodes. The overall value of Δt is the minimum of all nodal Δt_i 's.

Feasible elements are all linear volumetric elements (F3D4, F3D6 and F3D8).

For gases a shock capturing technique has been implemented following [110]. This is essentially a smoothing procedure. To this end a field Sa_i is determined for each node i as follows:

$$Sa_i = \frac{|\sum_j (p_i - p_j)|}{\sum_j |p_i - p_j|}, \quad (705)$$

where the sum is over all neighboring nodes and p is the static pressure. It can be verified that $Sa_i = 1$ for a local maximum and $Sa_i = 0$ if the pressure varies linearly. So Sa_i is a measure for discontinuous pressure changes. The smoothing procedure is such that the smoothed field \bar{x} is derived from the field x by

$$\bar{x}_i = x_i + \frac{\Delta t C_e Sa_i}{\Delta t_i} [M_L]_{ii}^{-1} ([M]_{ij} - [M_L]_{ij}) x_j. \quad (706)$$

$[M]$ is the left hand side matrix for the variable involved, $[M_L]$ is the lumped matrix (i.e. the matrix $[M]$ where all values in each row are summed and put on the diagonal, all off-diagonal terms are zero) and C_e is a parameter between 0 and 2. The bigger C_e , the stronger the smoothing. This procedure was elaborated on in [110]. After the regular calculation of ρv_i , ρ and $\rho \varepsilon_t$, the temperature T and the pressure p are calculated, the field Sa is determined and all conservative variables are smoothed. This leads to new values after which the boundary conditions for the velocity, the static pressure and static temperature are enforced again. If no convergence is reached, a new iteration is started.

It is important to note that for CFD calculations adiabatic boundary conditions have to be specified explicitly by using a *DFLUX card with zero heat flux. This is different from solid mechanics applications, where the absence of

a *DFLUX or *DLOAD card automatically implies zero distributed heat flux and zero pressure, respectively.

Finally, it is worth noting that the construction of the right hand side of the systems of equations to solve has been parallelized (multithreading). Therefore you need the lpthread library at linking time. By setting the OMP_NUM_THREADS environment variable you can specify how many CPUs you would like to use (see Section 2).

6.9.20 Shallow water calculations

Calculations for incompressible fluids with a free surface are quite important in marine and oceanographic applications. The challenging part here is to predict the location of the free surface. A special subcategory are the problems in which the depth of the fluid is small compared to the other dimensions. In that case the general equations can be reduced to the so-called shallow water equations. These equations have a very similar behavior as the Navier-Stokes equations for compressible fluids, treated in the previous section. Linearization of these equations leads to the linear shallow water equations treated in Section 6.9.10.

Starting point for the derivation of the shallow water equations are the conservation of mass and momentum for incompressible fluids:

$$v_{i,i} = 0 \quad (707)$$

and

$$\frac{\partial v_j}{\partial t} + \frac{\partial}{\partial x_i}(v_i v_j) + \frac{1}{\rho} \frac{\partial p}{\partial x_j} - \frac{1}{\rho} \frac{\partial t_{ij}}{\partial x_i} - f_j = 0. \quad (708)$$

Now, the depth-direction of the fluid is assumed to coincide with the x_3 -direction. The momentum equation in the x_3 -direction now reads:

$$\frac{Dv_3}{Dt} + \frac{1}{\rho} \frac{\partial p}{\partial x_3} - \frac{1}{\rho} \frac{\partial t_{i3}}{\partial x_i} - f_3 = 0. \quad (709)$$

The velocity in depth direction (first term) is assumed to be negligible as well as the viscous stress components t_{i3} . Furthermore, the volumetric force density is assumed to reduce to the gravity g . Consequently, one obtains:

$$\frac{1}{\rho} \frac{\partial p}{\partial x_3} + g = 0. \quad (710)$$

Now, the depth is supposed to be composed of two contributions: a portion H extending from $x_3 = -H$ ($H > 0$) up to $x_3 = 0$, and a portion η extending from $x_3 = 0$ up to $x_3 = \eta$ ($-\infty < \eta < \infty$), so that the depth h amounts to $h = H + \eta$ (Figure ...). Integrating the above equation and applying the boundary condition $p = p_a$ for $x_3 = \eta$, where p_a is the atmospheric pressure, one obtains:

$$p = \rho g(\eta - x_3) + p_a, \quad (711)$$

expressing the the pressure increases linearly from the surface into the depth direction.

The conservation of mass equation can be integrated in z-direction as follows:

$$\int_{-H}^{\eta} \frac{\partial v_1}{\partial x_1} dx_3 + \int_{-H}^{\eta} \frac{\partial v_2}{\partial x_2} dx_3 + \int_{-H}^{\eta} \frac{\partial v_3}{\partial x_3} dx_3 = 0. \quad (712)$$

Applying the Leibniz rule to the first two equations and direct integration to the last term leads to:

$$\begin{aligned} & \frac{\partial}{\partial x_1} \left(\int_{-H}^{\eta} v_1 dx_3 \right) - v_1(\eta) \frac{\partial \eta}{\partial x_1} - v_1(-H) \frac{\partial H}{\partial x_1} \\ & + \frac{\partial}{\partial x_2} \left(\int_{-H}^{\eta} v_2 dx_3 \right) - v_2(\eta) \frac{\partial \eta}{\partial x_2} - v_2(-H) \frac{\partial H}{\partial x_2} \\ & + v_3(\eta) - v_3(-H) = 0. \end{aligned} \quad (713)$$

The velocity at the bottom is zero, i.e. $v_1(-H) = v_2(-H) = v_3(-H) = 0$. Furthermore, a mean velocity is now defined by:

$$\bar{v}_i := \frac{1}{h} \int_{-H}^{\eta} v_i dx_3, \quad i = 1, 2. \quad (714)$$

This leads to:

$$\begin{aligned} & \frac{\partial}{\partial x_1} (\bar{v}_1 h) - v_1(\eta) \frac{\partial \eta}{\partial x_1} \\ & + \frac{\partial}{\partial x_2} (\bar{v}_2 h) - v_2(\eta) \frac{\partial \eta}{\partial x_2} \\ & + v_3(\eta) = 0. \end{aligned} \quad (715)$$

Now, the vertical velocity at the free surface can be written as:

$$v_3(\eta) := \frac{D\eta}{dt} = \frac{\partial \eta}{\partial t} + \frac{\partial \eta}{\partial x_1} v_1(\eta) + \frac{\partial \eta}{\partial x_2} v_2(\eta), \quad (716)$$

leading to:

$$\frac{\partial}{\partial x_1} (\bar{v}_1 h) + \frac{\partial}{\partial x_2} (\bar{v}_2 h) + \frac{\partial h}{\partial t} = 0, \quad (717)$$

since $\partial H / \partial t = 0$. With $\bar{v}_3 = 0$ one can also write:

$$\frac{\partial}{\partial x_i} (\bar{v}_i h) + \frac{\partial h}{\partial t} = 0. \quad (718)$$

This is identical to Equation 677 (conservation of mass for a compressible fluid) in which v_i is replaced by \bar{v}_i and ρ by h .

Integrating the momentum equation, i.e. Equation (708) in x_1 and x_2 direction across the depth leads to:

$$\begin{aligned}
& \frac{\partial}{\partial t}(\bar{u}_i h) - v_i(\eta) \frac{\partial \eta}{\partial t} - v_i(-H) \frac{\partial H}{\partial t} + \sum_{j=1}^2 \frac{\partial}{\partial x_j} \int_{-H}^{\eta} v_i v_j dx_3 \\
& - \sum_{j=1}^2 v_i(\eta) v_j(\eta) \frac{\partial \eta}{\partial x_j} - \sum_{j=1}^2 v_i(-H) v_j(-H) \frac{\partial H}{\partial x_j} + v_i(\eta) v_3(\eta) \\
& - v_i(-H) v_3(-H) + \frac{1}{\rho} \int_{-H}^{\eta} \frac{\partial p}{\partial x_i} - \frac{1}{\rho} \sum_{j=1}^2 \int_{-H}^{\eta} \frac{\partial t_{ij}}{\partial x_j} - \frac{1}{\rho} t_{i3}(\eta) \\
& + \frac{1}{\rho} t_{i3}(-H) - h \bar{f}_i = 0, \quad i = 1, 2
\end{aligned} \tag{719}$$

Since the velocity at the bottom is zero, the third, sixth and eighth term vanish. Due to the definition of the vertical velocity at the free surface, Equation (716) the second, fifth and seventh term also disappear. Due to Equation (711) the ninth term amounts to:

$$\frac{1}{\rho} \int_{-H}^{\eta} \frac{\partial p}{\partial x_i} = gh \frac{\partial \eta}{\partial x_i} + \frac{h}{\rho} \frac{\partial p_a}{\partial x_i}. \tag{720}$$

The fourth term is approximated by:

$$\begin{aligned}
\sum_{j=1}^2 \frac{\partial}{\partial x_j} \int_{-H}^{\eta} v_i v_j dx_3 &= \sum_{j=1}^2 \frac{\partial}{\partial x_j} \left(h \bar{v}_i \bar{v}_j + \int_{-H}^{\eta} \langle v \rangle_i \langle v \rangle_j \right) dx_3 \\
&\approx \sum_{j=1}^2 \frac{\partial}{\partial x_j} (h \bar{v}_i \bar{v}_j) dx_3,
\end{aligned} \tag{721}$$

and the tenth term is neglected. This leads to:

$$\begin{aligned}
\frac{\partial}{\partial t} (h \bar{u}_i) + \sum_{j=1}^2 \frac{\partial}{\partial x_j} h \bar{v}_i \bar{v}_j &= -gh \frac{\partial \eta}{\partial x_i} - \frac{h}{\rho} \frac{\partial p_a}{\partial x_i} + \frac{1}{\rho} t_{i3}^s \\
&\quad - \frac{1}{\rho} t_{i3}^b + h \bar{f}_i, \quad i = 1, 2
\end{aligned} \tag{722}$$

Now, $h \partial \eta / \partial x_i$ can also be written as:

$$h \frac{\partial \eta}{\partial x_i} = \frac{\partial}{\partial x_i} \left(\frac{h^2 - H^2}{2} \right) - (h - H) \frac{\partial H}{\partial x_i}, \tag{723}$$

leading to:

$$\begin{aligned} \frac{\partial}{\partial t}(h\bar{u}_i) + \sum_{j=1}^2 \frac{\partial}{\partial x_j} h\bar{v}_i\bar{v}_j = & -\frac{\partial \bar{p}}{\partial x_i} + g(h-H) \frac{\partial H}{\partial x_i} - \frac{h}{\rho} \frac{\partial p_a}{\partial x_i} \\ & + \frac{1}{\rho} t_{i3}^s - \frac{1}{\rho} t_{i3}^b + h\bar{f}_i, \quad i = 1, 2 \end{aligned} \quad (724)$$

were an artificial pressure \bar{p} has been defined by:

$$\bar{p} := \frac{g(h^2 - H^2)}{2}. \quad (725)$$

Since there is no variation in depth direction and setting $t_{33}^s = t_{33}^b = f_3 = 0$ this also amounts to:

$$\begin{aligned} \frac{\partial}{\partial t}(h\bar{u}_i) + \frac{\partial}{\partial x_j} h\bar{v}_i\bar{v}_j = & -\frac{\partial \bar{p}}{\partial x_i} + g(h-H) \frac{\partial H}{\partial x_i} - \frac{h}{\rho} \frac{\partial p_a}{\partial x_i} \\ & + \frac{1}{\rho} t_{i3}^s - \frac{1}{\rho} t_{i3}^b + h\bar{f}_i, \quad i = 1, 3. \end{aligned} \quad (726)$$

This amounts to the conservation of momentum equation (673) for a compressible fluid with the density ρ replaced by h , v_i replaced by \bar{v}_i , p replaced by \bar{p} , t_{ik} neglected and ρg_i replaced by

$$g(h-H) \frac{\partial H}{\partial x_i} - \frac{h}{\rho} \frac{\partial p_a}{\partial x_i} + \frac{1}{\rho} t_{i3}^s - \frac{1}{\rho} t_{i3}^b + h\bar{f}_i. \quad (727)$$

The friction stress at the bottom is frequently modeled by a hydraulic resistance type formula such as

$$t_{i3}^b = \frac{f}{8} \rho \|\bar{\mathbf{v}}\| \bar{v}_i. \quad (728)$$

The energy equation can be integrated in a similar way. It can be used if some fluid at a higher temperature is released into the flow and one would like to study the spread of the heat. The equation for incompressible flow runs:

$$\frac{\partial \varepsilon_t}{\partial t} + \frac{\partial}{\partial x_i} (v_i \varepsilon_t) = \frac{1}{\rho} \frac{\partial}{\partial x_i} \left(k \frac{\partial T}{\partial x_i} \right) - \frac{1}{\rho} \frac{\partial v_i p}{\partial x_i} + \frac{1}{\rho} \frac{\partial}{\partial x_i} (t_{ij} v_j) + f_i v_i + h^\theta \quad (729)$$

Integrating from $-H$ to η yields:

$$\begin{aligned}
& \frac{\partial}{\partial t} \int_{-H}^{\eta} \varepsilon_t dx_3 - \frac{\partial \eta}{\partial t} \varepsilon_t(\eta) - \frac{\partial H}{\partial t} \varepsilon_t(-H) \\
& + \sum_{i=1}^2 \frac{\partial}{\partial x_i} \int_{-H}^{\eta} v_i \varepsilon_t dx_3 - \sum_{i=1}^2 \frac{\partial \eta}{\partial x_i} (v_i \varepsilon_t)|_{\eta} - \sum_{i=1}^2 \frac{\partial H}{\partial x_i} (v_i \varepsilon_t)|_{-H} \\
& + (v_3 \varepsilon_t)|_{\eta} - (v_3 \varepsilon_t)|_{-H} = \sum_{i=1}^2 \frac{1}{\rho} \int_{-H}^{\eta} \frac{\partial}{\partial x_i} \left(k \frac{\partial T}{\partial x_i} \right) dx_3 \\
& - \frac{1}{\rho} (q^s + q^b) - \sum_{i=1}^3 \frac{1}{\rho} \int_{-H}^{\eta} v_i \frac{\partial p}{\partial x_i} dx_3 + \sum_{i=1}^2 \frac{1}{\rho} \int_{-H}^{\eta} \frac{\partial}{\partial x_i} (t_{ij} v_j) dx_3 \\
& + \left. \frac{t_{3j} v_j}{\rho} \right|_{\eta} - \left. \frac{t_{3j} v_j}{\rho} \right|_{-H} + \int_{-H}^{\eta} f_i v_i dx_3 + h \bar{h}^{\theta}. \tag{730}
\end{aligned}$$

Terms 3, 6 and 8 on the left hand side and term 6 on the right hand side are zero (no velocity at the bottom and no change in time of the bottom level). Terms 2, 5 and 7 on the left hand side disappear due to Equation (716). The integral in the first term on left hand side is replaced by definition by $\bar{\varepsilon}_t h$ and the integral in the fourth term is approximated by $\bar{v}_i \bar{\varepsilon}_t h$. The variables q^s and q^b in the second term on the right hand side are the heat flux flowing out of the fluid at the surface and the bottom, respectively.

Substituting the expression for the pressure, i.e. Equation (711) into the third term on the right hand side yields (the summation in that term really only extends from 1 to 2 since v_3 is negligible):

$$\sum_{i=1}^3 \frac{1}{\rho} \int_{-H}^{\eta} v_i \frac{\partial p}{\partial x_i} dx_3 = \sum_{i=1}^2 \bar{v}_i \frac{\partial \bar{p}}{\partial x_i} - \sum_{i=1}^2 \bar{v}_i g (h - H) \frac{\partial H}{\partial x_i} + \frac{h}{\rho} \sum_{i=1}^2 \bar{v}_i \frac{\partial p_a}{\partial x_i}. \tag{731}$$

The first and the fourth term on the right hand side is neglected and the eighth term is approximated by $\bar{f}_i \bar{v}_i h$. This finally yields:

$$\begin{aligned}
\frac{\partial}{\partial t} (h \bar{\varepsilon}_t) + \frac{\partial}{\partial x_i} [(h \bar{\varepsilon}_t + \bar{p}) \bar{v}_i] & \approx - \frac{1}{\rho} (q^s + q^b) + \bar{v}_i g (h - H) \frac{\partial H}{\partial x_i} - \frac{h}{\rho} \frac{\partial p_a}{\partial x_i} \bar{v}_i \\
& + \left. \frac{t_{3j} v_j}{\rho} \right|_{\eta} + h \bar{f}_i \bar{v}_i + h \bar{h}^{\theta}. \tag{732}
\end{aligned}$$

This is equivalent to the energy equation for compressible fluids with ρ replaced by h and appropriate source terms. The neglect of the stress and conduction terms (except in x_3 -direction) can be obtained by setting $\mu = \lambda = 0$. No specific gas constant has to be defined. The parameter COMPRESSIBLE on the *CFD card has to be replaced by the SHALLOW WATER parameter. The pressure initial and boundary conditions have to be replaced by conditions for $\bar{p} = g(h^2 - H^2)/2$. If H corresponds to the fluid surface in rest, the initial conditions usually reduce to $\bar{p} = 0$.

6.9.21 Substructure Generation

This procedure can be used to create the stiffness matrix of a substructure (sometimes also called a superelement) and store it in a file. A substructure consists of selected degrees of freedom of a model. It can be used in a subsequent linear analysis (this option is not available in CalculiX). In such an analysis, only the selected degrees of freedom are addressable, e.g. to apply loads or boundary conditions. The other degrees of freedom have been removed, thereby substantially reducing the size of the stiffness matrix. The retained degrees of freedom kind of constitute a new element (which explains the term superelement).

The stiffness matrix is obtained by successively applying a unit displacement to one of the retained nodes in one global direction while setting all other displacement values in the retained nodes to zero. This yields one column in the stiffness matrix of the superelement. Notice that in order to obtain the correct stiffness matrix only the elements belonging to the superelement should be retained in the input deck. Any other elements will influence the stiffness matrix and lead to a wrong matrix.

The substructure generation is triggered by the procedure card `*SUBSTRUCTURE GENERATE`. The degrees of freedom which should be retained can be defined by using the `*RETAINED NODAL DOFS` card. No transformation is allowed, consequently, the degrees of freedom apply to the global Cartesian system. Finally, the storage of the stiffness matrix is governed by the `*SUBSTRUCTURE MATRIX OUTPUT` card, specifying the name of the file without extension. The extension `.mtx` is default. The stiffness matrix can be stored in a `USER DEFINED` format or in a `MATRIX` format.

If the storage is in `USER DEFINED` format (`OUTPUT FILE=USER DEFINED` on the `*SUBSTRUCTURE MATRIX OUTPUT` card) the output in the `.mtx` file constitutes the input one needs to use the superelement in ABAQUS. It consists of:

- a `*USER ELEMENT` card specifying the number of degrees of freedom involved in the substructure (misleadingly defined as “nodes”).
- a list of the nodes. Each node is listed as many times as the number of its degrees of freedom in the substructure.
- for each retained degree of freedom its global direction. The format for the first degree of freedom of the substructure is just the global direction. For the subsequent degrees of freedom it consists of the number of the degree of freedom followed by the global direction
- a `*MATRIX,TYPE=STIFFNESS` card followed by the upper triangle (including the diagonal) of the stiffness matrix, column by column, and comma separated.

If the storage is in `MATRIX` format (`OUTPUT FILE=MATRIX` on the `*SUBSTRUCTURE MATRIX OUTPUT` card) the resulting file can be used in a `*MATRIX ASSEMBLE` card for further usage in CalculiX.

6.9.22 Electromagnetism

In CalculiX, certain types of electromagnetic calculations are possible. These include:

- electrostatic calculations: these can be performed as a special case of thermal calculations, cf. Section 6.9.13.
- magnetostatic calculations. Due to the absence of time derivatives the interaction between electric and magnetic fields drops out and the magnetic equations can be considered on their own.
- magnetic induction calculations. These are calculations without fixed electric charges and in which the displacement current can be neglected. The major industrial application for this type of calculation is inductive heating.

In this section only the last two applications are treated. The governing Maxwell equations run like (the displacement current term was dropped in Equation (736)):

$$\nabla \cdot \mathbf{D} = \rho \quad (733)$$

$$\nabla \times \mathbf{E} = -\frac{\partial \mathbf{B}}{\partial t} \quad (734)$$

$$\nabla \cdot \mathbf{B} = 0 \quad (735)$$

$$\nabla \times \mathbf{H} = \mathbf{j} \quad (736)$$

where \mathbf{E} is the electric field, \mathbf{D} is the electric displacement field, \mathbf{B} is the magnetic field, \mathbf{H} is the magnetic intensity, \mathbf{j} is the electric current density and ρ is the electric charge density. These fields are connected by the following constitutive equations:

$$\mathbf{D} = \epsilon \mathbf{E} \quad (737)$$

$$\mathbf{B} = \mu \mathbf{H} \quad (738)$$

and

$$\mathbf{j} = \sigma \mathbf{E}. \quad (739)$$

Here, ϵ is the permittivity, μ is the magnetic permeability and σ is the electrical conductivity. For the present applications ϵ and \mathbf{D} are not needed and Equation (733) can be discarded. It will be assumed that these relationships are linear and isotropic, the material parameters, however, can be temperature

Table 17: Frequently used units electromagnetic applications.

symbol	meaning	unit
I	current	A
E	electric field	$\frac{V}{m} = \frac{kg \cdot m}{A \cdot s^3}$
D	electric displacement field	$\frac{C}{m^2} = \frac{A \cdot s}{m^2}$
B	magnetic field	$T = \frac{kg}{A \cdot s^2}$
H	magnetic intensity	$\frac{A}{m}$
j	current density	$\frac{A}{m^2}$
ϵ	permittivity	$\frac{F}{m} = \frac{A^2 \cdot s^4}{kg \cdot m^3}$
μ	magnetic permeability	$\frac{kg \cdot m}{A^2 \cdot s^2}$
σ	electrical conductivity	$\frac{S}{m} = \frac{A^2 \cdot s^3}{kg \cdot m^3}$
P	magnetic scalar potential	A
V	electric scalar potential	$V = \frac{kg \cdot m^2}{A \cdot s^3}$
A	magnetic vector potential	$\frac{kg \cdot m}{A \cdot s^2}$

dependent. So no hysteresis is considered, which basically means that only paramagnetic and diamagnetic materials are considered. So far, no ferromagnetic materials are allowed.

Due to electromagnetism, an additional basic unit is needed, the Ampère (A). All other quantities can be written using the SI-units A, m, s, kg and K, however, frequently derived units are used. An overview of these units is given in Table 17 (V=Volt, C=Coulomb, T=Tesla, F=Farad, S=Siemens).

In what follows the references [86] and [43] have been used. In inductive heating applications the domain of interest consists of the objects to be heated (= workpiece), the surrounding air and the coils providing the current leading to the induction. It will be assumed that the coils can be considered separately as a driving force without feedback from the system. This requires the coils to be equipped with a regulating system counteracting any external influence trying

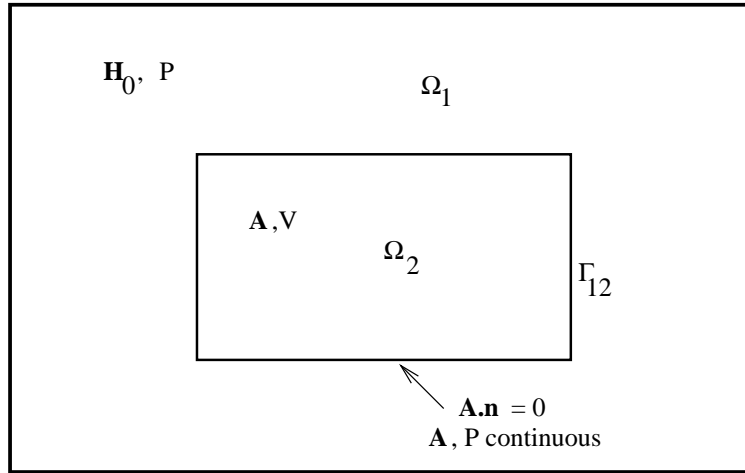

Figure 150: Electromagnetic setup for simply connected bodies

to modify the current as intended by the user.

Let us first try to understand what happens physically. In the simplest case the volume to be analyzed consists of a simply connected body surrounded by air, Figure 150. A body is simply connected if any fictitious closed loop within the body can be reduced to a point without leaving the body. For instance, a sphere is simply connected, a ring is not. The coil providing the current is located within the air. Turning on the current leads to a magnetic intensity field through Equation (736) and a magnetic field through Equation (738) everywhere, in the air and in the body. If the current is not changing in time, this constitutes the solution to the problem.

If the current is changing in time, so is the magnetic field, and through Equation (734) one obtains an electric field everywhere. This electric field generates a current by Equation (739) (called Eddy current) in any part which is electrically conductive, i.e. generally in the body, but not in the air. This current generates a magnetic intensity field by virtue of Equation (736), in a direction which is opposite to the original magnetic intensity field. Thus, the Eddy currents oppose the generation of the magnetic field in the body. Practically, this means that the magnetic field in the body is not built up at once. Rather, it is built up gradually, in the same way in which the temperature in a body due to heat transfer can only change gradually. As a matter of fact, both phenomena are described by first order differential equations in time. The Ohm-losses of the Eddy currents are the source of the heat generation used in industrial heat induction applications.

From these considerations one realizes that in the body (domain 2, cf. Figure 150; notice that domain 1 and 2 are interchanged compared to [86]) both the

that there are no current conducting coils in domain 3. The remaining air is domain 1 described by the scalar magnetic potential P .

In the different domains, different equations have to be solved. In domain 1 the electric field is not important, since there is no conductance. Therefore, it is sufficient to calculate the magnetic field, and only Equations (735) and (736) have to be satisfied. Using the ansatz in Equation (740), Equation (736) is automatically satisfied, since it is satisfied by \mathbf{T}_0 and the curl of the gradient vanishes. The only equation left is (735). One arrives at the equation

$$\nabla \cdot \mu(\mathbf{T}_0 - \nabla P) = 0. \quad (744)$$

In domain 2, Equations (734), (735) and (736) have to be satisfied, using the approach of Equations (741) and (742). Taking the curl of Equation (742) yields Equation (734). Taking the divergence of Equation (741) yields Equation (735). Substituting Equations (741) and (742) into Equation (736) leads to:

$$\nabla \times \frac{1}{\mu}(\nabla \times \mathbf{A}) + \sigma \frac{\partial \mathbf{A}}{\partial t} + \sigma \nabla V = 0. \quad (745)$$

The magnetic vector potential \mathbf{A} is not uniquely defined by Equation (741). The divergence of \mathbf{A} can still be freely defined. Here, we take the Coulomb gauge, which amounts to setting

$$\nabla \cdot \mathbf{A} = 0. \quad (746)$$

Notice that the fulfillment of Equation (736) automatically satisfies the conservation of charge, which runs in domain 2 as

$$\nabla \cdot \mathbf{j} = 0, \quad (747)$$

since there is no concentrated charge. Thus, for a simply connected body we arrive at the Equations (744) (domain 1), (745) (domain 2) and (746) (domain 2). In practice, Equations (745) and (746) are frequently combined to yield

$$\nabla \times \frac{1}{\mu}(\nabla \times \mathbf{A}) - \nabla \frac{1}{\mu} \nabla \cdot \mathbf{A} + \sigma \frac{\partial \mathbf{A}}{\partial t} + \sigma \nabla V = 0. \quad (748)$$

This, however, is not any more equivalent to the solution of Equation (736) and consequently the satisfaction of Equation (747) has now to be requested explicitly:

$$\nabla \cdot \sigma \left(\frac{\partial \mathbf{A}}{\partial t} + \nabla V \right) = 0. \quad (749)$$

Consequently, the equations to be solved are now Equations (748) (domain 2), (749) (domain 2), and (744) (domain 1).

In domain 3, only Equations (735) and (736) with $\mathbf{j} = 0$ have to be satisfied (the coils are supposed to be in domain 1). Using the ansatz from Equation (741), Equation (735) is automatically satisfied and Equation (736) now amounts to

$$\nabla \times \frac{1}{\mu}(\nabla \times \mathbf{A}) - \nabla \frac{1}{\mu} \nabla \cdot \mathbf{A} = 0. \quad (750)$$

The boundary conditions on the interface amount to:

- continuity of the normal component of \mathbf{B}
- continuity of the tangential component of \mathbf{H} , and
- no current flow orthogonal to the boundary, or (\mathbf{n}_i is the normal on domain i , pointing away from the domain):

$$\mathbf{B}_1 \cdot \mathbf{n}_1 + \mathbf{B}_2 \cdot \mathbf{n}_2 = 0, \quad (751)$$

$$\mathbf{H}_1 \times \mathbf{n}_1 + \mathbf{H}_2 \times \mathbf{n}_2 = 0 \quad (752)$$

and

$$\mathbf{j}_2 \cdot \mathbf{n}_2 = 0 \quad (753)$$

all of which have to be satisfied on Γ_{12} . In terms of the magnetic vector potential \mathbf{A} , electric scalar potential V and magnetic scalar potential P this amounts to:

$$\mu(\mathbf{T}_0 - \nabla P) \cdot \mathbf{n}_1 + (\nabla \times \mathbf{A}) \cdot \mathbf{n}_2 = 0, \quad (754)$$

$$(\mathbf{T}_0 - \nabla P) \times \mathbf{n}_1 + \frac{1}{\mu_1}(\nabla \times \mathbf{A}) \times \mathbf{n}_2 = 0 \quad (755)$$

and

$$\left(\frac{\partial \mathbf{A}}{\partial t} + \nabla V\right)_2 \cdot \mathbf{n}_2 = 0 \quad (756)$$

on Γ_{12} . For uniqueness, the electric potential has to be fixed in one node and the normal component of \mathbf{A} has to vanish along Γ_{12} [86]:

$$\mathbf{A} \cdot \mathbf{n}_2 = 0. \quad (757)$$

To obtain the weak formulation of the above equations they are multiplied with trial functions and integrated. The trial functions will be denoted by $\delta \mathbf{A}$, δV and δP . Starting with Equation(748) one obtains after multiplication with $\delta \mathbf{A}$ and taking the vector identities

$$\nabla \cdot (\mathbf{a} \times \mathbf{b}) = (\nabla \times \mathbf{a}) \cdot \mathbf{b} - \mathbf{a} \cdot (\nabla \times \mathbf{b}) \quad (758)$$

$$\nabla \cdot (\alpha \mathbf{a}) = \nabla \alpha \cdot \mathbf{a} + \alpha \nabla \cdot \mathbf{a} \quad (759)$$

into account (set $\mathbf{b} = (\nabla \times \mathbf{A})/\mu$ in the first vector identity):

$$\begin{aligned} & \frac{1}{\mu}(\nabla \times \delta \mathbf{A}) \cdot (\nabla \times \mathbf{A}) - \nabla \cdot (\delta \mathbf{A} \times \frac{1}{\mu} \nabla \times \mathbf{A}) + \frac{1}{\mu}(\nabla \cdot \mathbf{A})\nabla \cdot (\delta \mathbf{A}) \\ & - \nabla \cdot [\frac{1}{\mu}(\nabla \cdot \mathbf{A})\delta \mathbf{A}] + \delta \mathbf{A} \cdot \sigma \left(\frac{\partial \mathbf{A}}{\partial t} + \nabla V \right) = 0. \end{aligned} \quad (760)$$

Integrating one obtains, using Gauss' theorem (it is assumed that Ω_2 has no free boundary, i.e. no boundary not connected to Ω_1):

$$\begin{aligned} & \int_{\Omega_2} \frac{1}{\mu}(\nabla \times \delta \mathbf{A}) \cdot (\nabla \times \mathbf{A}) d\Omega - \int_{\Gamma_{12}} \frac{1}{\mu}(\delta \mathbf{A} \times \nabla \mathbf{A}) \cdot \mathbf{n}_2 dS + \\ & \int_{\Omega_2} \frac{1}{\mu}(\nabla \cdot \mathbf{A})(\nabla \cdot \delta \mathbf{A}) d\Omega - \int_{\Gamma_{12}} \frac{1}{\mu}(\nabla \cdot \mathbf{A})\delta \mathbf{A} \cdot \mathbf{n}_2 dS + \\ & \int_{\Omega_2} \delta \mathbf{A} \cdot \sigma \left(\frac{\partial \mathbf{A}}{\partial t} + \nabla V \right) d\Omega = 0 \end{aligned} \quad (761)$$

The trial functions also have to satisfy the kinematic constraints. Therefore, $\delta \mathbf{A} \cdot \mathbf{n}_2 = 0$ and the second surface integral is zero.

Applying the vector identity

$$(\mathbf{a} \times \mathbf{b}) \cdot \mathbf{n} = \mathbf{a} \cdot (\mathbf{b} \times \mathbf{n}) \quad (762)$$

and the boundary condition from Equation (755), the integrand of the first surface integral can be written as:

$$\begin{aligned} & \frac{1}{\mu}(\delta \mathbf{A} \times \nabla \times \mathbf{A}) \cdot \mathbf{n}_2 = \\ & \frac{1}{\mu}(\delta \mathbf{A} \cdot [(\nabla \times \mathbf{A}) \times \mathbf{n}_2]) = \\ & - \delta \mathbf{A} \cdot [(\mathbf{T}_0 - \nabla P) \times \mathbf{n}_1]. \end{aligned} \quad (763)$$

Consequently, the integral now amounts to:

$$\int_{\Gamma_{12}} [-\delta \mathbf{A} \cdot (\mathbf{T}_0 \times \mathbf{n}_2) + \delta \mathbf{A} \cdot (\nabla P \times \mathbf{n}_2)] dS. \quad (764)$$

Applying the same vector identity from above one further arrives at:

$$\int_{\Gamma_{12}} [-\delta \mathbf{A} \cdot (\mathbf{T}_0 \times \mathbf{n}_2) + \mathbf{n}_2 \cdot (\delta \mathbf{A} \times \nabla P)] dS. \quad (765)$$

Finally, using the vector identity:

$$\mathbf{n}_2 \cdot (\delta \mathbf{A} \times \nabla P) = P[\mathbf{n}_2 \cdot (\nabla \times \delta \mathbf{A})] - \mathbf{n}_2 \cdot [\nabla \times (P\delta \mathbf{A})] \quad (766)$$

one obtains

$$\int_{\Gamma_{12}} \{-\delta \mathbf{A} \cdot (\mathbf{T}_0 \times \mathbf{n}_2) + P[\mathbf{n}_2 \cdot (\nabla \times \delta \mathbf{A})] - \mathbf{n}_2 \cdot [\nabla \times (P\delta \mathbf{A})]\} dS. \quad (767)$$

The last integral vanishes if the surface is closed due to Stokes' Theorem.

Now the second equation, Equation (749), is being looked at. After multiplication with δV it can be rewritten as:

$$\nabla \cdot \left[\delta V \sigma \left(\frac{\partial \mathbf{A}}{\partial t} + \nabla V \right) \right] - \nabla \delta V \cdot \sigma \left(\frac{\partial \mathbf{A}}{\partial t} + \nabla V \right) = 0. \quad (768)$$

After integration and application of Gauss' theorem one ends up with the last term only, due to the boundary condition from Equation (756).

Analogously, the third equation, Equation (744) leads to:

$$\nabla \cdot (\delta P \mu [\mathbf{T}_0 - \nabla P]) - \nabla \delta P \cdot \mu (\mathbf{T}_0 - \mu \nabla P) = 0. \quad (769)$$

After integration this leads to (on external faces of Ω_1 , i.e. faces not connected to Ω_2 or Ω_3 the condition $\mathbf{B} \cdot \mathbf{n}_1 = 0$ is applied) :

$$\int_{\Omega_1} \nabla \delta P \cdot \mu (\mathbf{T}_0 - \mu \nabla P) d\Omega - \int_{\Gamma_{12}} \delta P \mu (\mathbf{T}_0 - \nabla P) \cdot \mathbf{n}_1 dS = 0. \quad (770)$$

Applying the boundary condition from Equation (754) leads to:

$$\int_{\Omega_1} \nabla \delta P \cdot \mu (\mathbf{T}_0 - \mu \nabla P) d\Omega + \int_{\Gamma_{12}} \delta P (\nabla \times \mathbf{A}) \cdot \mathbf{n}_2 dS = 0. \quad (771)$$

So one finally obtains for the governing equations :

$$\begin{aligned} & \int_{\Omega_2} \frac{1}{\mu} (\nabla \times \delta \mathbf{A}) \cdot (\nabla \times \mathbf{A}) d\Omega + \int_{\Omega_2} \frac{1}{\mu} (\nabla \cdot \delta \mathbf{A}) (\nabla \cdot \mathbf{A}) d\Omega + \\ & \int_{\Omega_2} (\delta \mathbf{A}) \cdot \sigma \left(\frac{\partial \mathbf{A}}{\partial t} + \nabla \frac{\partial v}{\partial t} \right) d\Omega + \int_{\Gamma_{12}} P (\nabla \times \delta \mathbf{A}) \cdot \mathbf{n}_2 dS \\ & = \int_{\Gamma_{12}} \delta \mathbf{A} \cdot (\mathbf{T}_0 \times \mathbf{n}_2) dS \end{aligned} \quad (772)$$

$$\int_{\Omega_2} \nabla \delta V \cdot \sigma \left(\frac{\partial \mathbf{A}}{\partial t} + \nabla \frac{\partial v}{\partial t} \right) d\Omega = 0 \quad (773)$$

$$\begin{aligned} & - \int_{\Omega_1} \mu \nabla \delta P \cdot \nabla P d\Omega + \int_{\Gamma_{12}} (\delta P) (\nabla \times \mathbf{A}) \cdot \mathbf{n}_2 dS \\ & = \int_{\Omega_1} \mu \nabla \delta P \cdot \mathbf{T}_0 d\Omega. \end{aligned} \quad (774)$$

Using the standard shape functions one arrives at (cf. Chapter 2 in [23]):

$$\begin{aligned}
& \sum_e \sum_{i=1}^N \sum_{j=1}^N \left\{ \left[\int_{V_{0e2}} \varphi_{i,L} \frac{1}{\mu} \varphi_{j,L} \delta_{KM} dV_e \right] \delta A_{iK} A_{jM} - \right. \\
& \quad \left[\int_{V_{0e2}} \varphi_{i,M} \frac{1}{\mu} \varphi_{j,K} dV_e \right] \delta A_{iK} A_{jM} + \\
& \quad \left[\int_{V_{0e2}} \varphi_{i,K} \frac{1}{\mu} \varphi_{j,M} dV_e \right] \delta A_{iK} A_{jM} + \\
& \quad \left[\int_{V_{0e2}} \varphi_i \sigma \varphi_j dV_e \delta_{KM} \right] \delta A_{iK} \frac{DA_{jM}}{t} + \\
& \quad \left[\int_{V_{0e2}} \varphi_i \sigma \varphi_{j,K} dV_e \right] \delta A_{iK} \frac{Dv_j}{Dt} + \\
& \quad \left. \left[\int_{A_{0e12}} e_{KLM} \varphi_i \varphi_{j,L} n_{2K} dA_e \right] \delta A_{jM} P_i \right\} = \\
& - \sum_e \sum_{j=1}^N \left[\int_{A_{0e12}} e_{KLM} \varphi_j T_{0L} n_{2K} dA_e \right] \delta A_{jM} \quad (775)
\end{aligned}$$

$$\begin{aligned}
& \sum_e \sum_{i=1}^N \sum_{j=1}^N \left\{ \left[\int_{V_{0e2}} \varphi_{i,K} \sigma \varphi_i dV_e \right] \delta v_j \frac{DA_{iK}}{Dt} \right. \\
& \quad \left. \left[\int_{V_{0e2}} \varphi_{i,K} \sigma \varphi_{j,K} dV_e \right] \delta v_j \frac{Dv_j}{Dt} \right\} = 0 \quad (776)
\end{aligned}$$

$$\sum_e \sum_{i=1}^N \sum_{j=1}^N \left\{ \left[\int_{V_{0e1}} \varphi_{i,K} \mu \varphi_{j,K} dV_e \right] \delta P_i P_j \right\} \quad (777)$$

$$\left[\int_{A_{0e12}} \varphi_i e_{KLM} \varphi_{j,L} n_{2K} dA_e \right] \delta P_i A_{jM} \quad (778)$$

$$= - \sum_e \sum_i \left[\int_{V_{0e1}} \mu \varphi_{i,K} T_{0K} dV_e \right] \delta P_i. \quad (779)$$

Notice that the first two equations apply to domain 2, the last one applies to domain 1. In domain 3 only the first equation applies, in which the time dependent terms are dropped.

This leads to the following matrices:

$$[K_{AA}]_{e(iK)(jM)} = \int_{(V_{0e})_{\Omega_2}} \frac{1}{\mu} [\varphi_{i,L} \varphi_{j,L} \delta_{KM} - \varphi_{i,M} \varphi_{j,K} + \varphi_{i,K} \varphi_{j,M}] dV_e \quad (780)$$

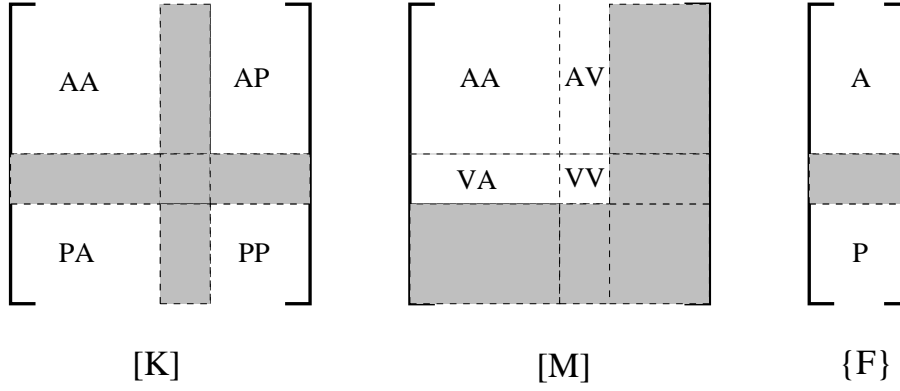

Figure 152: Nonzero parts of the governing matrices

$$[K_{AP}]_{e(jM)(i)} = \int_{(A_{0e})_{\Gamma_{12}}} e_{KLM} \varphi_i \varphi_{j,L} n_{1K} dA_e \quad (781)$$

$$[K_{PA}]_{e(i)(jM)} = \int_{(A_{0e})_{\Gamma_{12}}} e_{KLM} \varphi_i \varphi_{j,L} n_{1K} dA_e \quad (782)$$

$$[K_{PP}]_{e(i)(j)} = - \int_{(V_{0e})_{\Omega_1}} \mu \varphi_{i,K} \varphi_{j,K} dV_e \quad (783)$$

$$[M_{AA}]_{e(iK)(jM)} = \int_{(V_{0e})_{\Omega_2}} \varphi_i \sigma \varphi_j \delta_{KM} dV_e \quad (784)$$

$$[M_{Av}]_{e(iK)(j)} = \int_{(V_{0e})_{\Omega_2}} \varphi_i \sigma \varphi_{j,K} \delta_{KM} dV_e \quad (785)$$

$$[M_{vA}]_{e(j)(iK)} = \int_{(V_{0e})_{\Omega_2}} \varphi_{j,K} \sigma \varphi_i \delta_{KM} dV_e \quad (786)$$

$$[M_{vv}]_{e(i)(j)} = \int_{(V_{0e})_{\Omega_2}} \varphi_{i,K} \sigma \varphi_{j,K} \delta_{KM} dV_e \quad (787)$$

$$\{F_A\}_{e(jM)} = - \int_{(A_{0e})_{\Gamma_{12}}} e_{KLM} \varphi_j T_{0L} n_{1K} dA_e \quad (788)$$

$$\{F_P\}_{e(i)} = - \int_{(V_{0e})_{\Omega_1}} \mu \varphi_{i,K} T_{0K} dV_e \quad (789)$$

Repeated indices imply implicit summation. The $[K]$ matrices are analogous to the conductivity matrix in heat transfer analyses, the $[M]$ matrices are the counterpart of the capacity matrix. $\{F\}$ represents the force. The resulting system consists of first order ordinary differential equations in time and the

corresponding matrices look like in Figure 152. Solution of this system yields the solution for \mathbf{A} , v and P from which the magnetic field \mathbf{B} and the electric field \mathbf{E} can be determined using Equations (741,742).

The internal electromagnetic forces amount to:

$$\begin{aligned} \{F_A\}_{(iK)} &= [K_{AA}]_{e(iK)(jM)} \cdot \{A\}_{(jM)} + [K_{AP}]_{e(iK)(j)} \cdot \{P\}_{(j)} \\ &= \frac{1}{\mu} \int_{(V_{0e})_{\Omega_2}} [\varphi_{i,L} A_{K,L} - \varphi_{i,M} A_{M,K} + \varphi_{i,K} A_{M,M}] dV_e \\ &= - \int_{(A_{0e})_{\Gamma_{12}}} e_{KLM} \varphi_{i,L} P n_{1M} dA_e \end{aligned} \quad (790)$$

and

$$\begin{aligned} \{F\}_{(i)} &= [K_{PA}]_{e(i)(jM)} \cdot \{A\}_{(jM)} + [K_{PP}]_{e(i)(j)} \cdot \{P\}_{(j)} \\ &= \int_{(A_{0e})_{\Gamma_{12}}} \varphi_i e_{KLM} A_{M,L} n_{1K} dA_e \\ &= - \int_{(V_{0e})_{\Omega_1}} \mu \varphi_{i,K} P_{,K} dV_e. \end{aligned} \quad (791)$$

They have to be in equilibrium with the external forces.

What does the above theory imply for the practical modeling? The conductor containing the driving current is supposed to be modeled using shell elements. The thickness of the shell elements can vary. The current usually flows near the surface (skin effect), so the modeling with shell elements is not really a restriction. The current and potential in the conductor is calculated using the heat transfer analogy. This means that potential boundary conditions have to be defined as temperature, current boundary conditions as heat flow conditions. The driving current containing conductor is completely separate from the mesh used to calculate the magnetic and electric fields. Notice that the current in the driving electromagnetic coils is not supposed to be changed by the electromagnetic field it generates.

The volumetric domains of interest are $\Omega_1 \Omega_2$ and Ω_3 . These three domains represent the air, the conducting workpiece and that part of the air which, if filled with workpiece material, makes the workpiece simply connected. These three domains are to be meshed with volumetric elements. The meshes should not be connected, i.e., one can mesh these domains in a completely independent way. This also applies that one can choose the appropriate mesh density for each domain separately.

Based on the driving current the field \mathbf{T}_0 is determined in domain 1 with the Biot-Savart law. This part of the code is parallelized, since the Biot-Savart integration is computationally quite expensive. Because of Equation (788) \mathbf{T}_0 is also determined on the external faces of domain 2 and 3 which are in contact with domain 1.

The following boundary conditions are imposed (through MPC's):

On the external faces of domain 1 which are in contact with domain 2 or domain 3:

- Calculation of \mathbf{A} based on the external facial values in domain 2 and 3 (cf. the area integrals in $[K]$)

On the external faces of domain 2 and 3 which are in contact with domain 1:

- Calculation of P based on the external facial values in domain 1.
- Imposition of $\mathbf{A} \cdot \mathbf{n} = 0$.

On the faces between domain 2 and 3:

- Continuity of \mathbf{A}

These MPC's are generated automatically within CalculiX and have not to be taken care of by the user. Finally, the value of V has to be fixed in at least one node of domain 2. This has to be done by the user with a *BOUNDARY condition on degree of freedom 8.

The material data to be defined include:

- the electrical conductivity in the driving coils
- the magnetic permeability in the air
- the density, the thermal conductivity, the specific heat, the electrical conductivity and the magnetic permeability in the workpiece.

To this end the cards *DENSITY, *CONDUCTIVITY, *SPECIFIC HEAT, *ELECTRICAL CONDUCTIVITY, MAGNETIC PERMEABILITY can be used. In the presence of thermal radiation the *PHYSICAL CONSTANTS card is also needed.

The procedure card is *ELECTROMAGNETICS. For magnetostatic calculations the parameter MAGNETOSTATICS is to be used, for athermal electromagnetic calculations the parameter NO HEAT TRANSFER. Default is an electromagnetic calculation with heat transfer.

Available output variables are POT (the electric potential in the driving current coil) on the *NODE FILE card and ECD (electric current density in the driving current coil), EMFE (electric field in the workpiece) and EMFB (magnetic field in the air and the workpiece) on the *EL FILE card. Examples are induction.inp and induction2.inp.

6.9.23 Sensitivity

A sensitivity analysis calculates how a variable G (called the objective function) changes with some other variables s (called the design variables), i.e. DG/Ds .

If s are the coordinates of some nodes, then the objective function usually takes the form $G(s, U(s))$, i.e. it is a direct function of the coordinates and it is a direct function of the displacements, which are again a function of the coordinates. One can write (vector- and matrix-denoting parentheses have been omitted; it is assumed that the reader knows that U and F are vectors, K and M are matrices and that s and G are potentially vectors):

$$\frac{DG}{Ds} = \frac{\partial G}{\partial s} + \frac{\partial G}{\partial U} \frac{\partial U}{\partial s}. \quad (792)$$

The governing equation for static (linear and nonlinear) calculations is $F_{\text{int}}(s, U(s)) = F_{\text{ext}}(s, U(s))$, which leads to

$$\frac{\partial F_{\text{int}}}{\partial s} + \frac{\partial F_{\text{int}}}{\partial U} \frac{\partial U}{\partial s} = \frac{\partial F_{\text{ext}}}{\partial s} + \frac{\partial F_{\text{ext}}}{\partial U} \frac{\partial U}{\partial s}. \quad (793)$$

or

$$\frac{\partial U}{\partial s} = K^{-1} \left(\frac{\partial F_{\text{ext}}}{\partial s} - \frac{\partial F_{\text{int}}}{\partial s} \right), \quad (794)$$

where

$$K = \frac{\partial F_{\text{int}}}{\partial U} - \frac{\partial F_{\text{ext}}}{\partial U}. \quad (795)$$

Since for linear applications $F_{\text{int}}(s, U(s)) = K(s) \cdot U$ and $F_{\text{ext}}(s, U(s)) = F(s)$, the above equations reduce in that case to

$$\frac{\partial K}{\partial s} \cdot U + K \cdot \frac{\partial U}{\partial s} = \frac{\partial F}{\partial s}, \quad (796)$$

or

$$\frac{\partial U}{\partial s} = K^{-1} \left(\frac{\partial F}{\partial s} - \frac{\partial K}{\partial s} \cdot U \right). \quad (797)$$

Consequently one arrives at the equation:

$$\frac{DG}{Ds} = \frac{\partial G}{\partial s} + \frac{\partial G}{\partial U} K^{-1} \left(\frac{\partial F}{\partial s} - \frac{\partial K}{\partial s} \cdot U \right). \quad (798)$$

For the speed-up of the calculations it is important to perform the calculation of the term $\frac{\partial K}{\partial s} \cdot U$ on element level and to calculate the term $\frac{\partial G}{\partial U} K^{-1}$ before multiplying with the last term in brackets. Furthermore, $\frac{\partial G}{\partial U} K^{-1}$ should be calculated by solving an equation system and not by inverting K .

For special objective functions this relationship is further simplified:

- if G is the mass $\frac{\partial G}{\partial U} = 0$.

- if G is the shape energy $\frac{\partial G}{\partial U} K^{-1} = U$.
- if G are the displacements Equation (797) applies directly

For eigenfrequencies as objective function one starts from the eigenvalue equation:

$$K \cdot U_i = \lambda_i M \cdot U_i, \quad (799)$$

from which one gets:

$$\frac{\partial \lambda_i}{\partial s} M \cdot U_i = (K - \lambda_i M) \cdot \frac{\partial U_i}{\partial s} + \left(\frac{\partial K}{\partial s} - \lambda_i \frac{\partial M}{\partial s} \right) \cdot U_i. \quad (800)$$

Premultiplying with U_i^T and taking the eigenvalue equation and the normalization of the eigenvectors w.r.t. M into account leads to

$$\frac{\partial \lambda_i}{\partial s} = U_i^T \cdot \left(\frac{\partial K}{\partial s} - \lambda_i \frac{\partial M}{\partial s} \right) \cdot U_i. \quad (801)$$

Notice that this is the sensitivity of the eigenvalues, not of the eigenfrequencies (which are the square roots of the eigenvalues). This is exactly how it is implemented in CalculiX: you get in the output the sensitivity of the eigenvalues.

Subsequently, one can derive the eigenvalue equation to obtain the derivatives of the eigenvectors:

$$(K - \lambda_i M) \frac{\partial U_i}{\partial s} = - \left(\frac{\partial K}{\partial s} - \lambda_i \frac{\partial M}{\partial s} - \frac{\partial \lambda_i}{\partial s} M \right) \cdot U_i. \quad (802)$$

If s is the orientation in some or all of the elements, the term $\frac{\partial G}{\partial s}$ is in addition zero in the above equations.

In CalculiX, G is defined with the keyword *DESIGN RESPONSE, s is defined with the keyword DESIGNVARIABLES and a sensitivity analysis is introduced with the procedure card *SENSITIVITY.

If the parameter NLGEOM is not used on the *SENSITIVITY card, the calculation of $\frac{\partial K}{\partial s}$ does not contain the large deformation and stress stiffness, else it does. Similarly, without NLGEOM $\frac{\partial G}{\partial s}$ is calculated based on the linear strains, else the quadratic terms are taken into account.

If the design response is the mass, the shape energy or the displacements a *STATIC step must have been performed. The displacements U and the stiffness matrix K from this step are taken for K and U in Equation (798) (in the presence of a subsequent sensitivity step K is stored automatically in a file with the name jobname.stm). If the static step was calculated with NLGEOM, so should the sensitivity step in order to be consistent. So the procedure cards should run like:

```
*STEP
*STATIC
...
```

```
*STEP
*SENSITIVITY
...
```

or

```
*STEP,NLGEOM
*STATIC
...
*STEP,NLGEOM
*SENSITIVITY
...
```

The NLGEOM parameter is kept if the *SENSITIVITY and *STATIC step are in the same input deck (so then NLGEOM does not have to be repeated on the *SENSITIVITY step).

If the objective functions are the eigenfrequencies (which include the eigenmodes), a *FREQUENCY step must have been performed with STORAGE=YES. This frequency step may be a perturbation step, in which case it is preceded by a static step. The displacements U , the stiffness matrix K and the mass matrix M for equations (801) and (802) are taken from the frequency step. If the frequency step is performed as a perturbation step, the sensitivity step should be performed with NLGEOM, else it is not necessary. So the procedure cards should run like:

```
*STEP
*FREQUENCY,STORAGE=YES
...
*STEP
*SENSITIVITY
...
```

or

```
*STEP
*STATIC
...
*STEP,PERTURBATION
*FREQUENCY,STORAGE=YES
...
*STEP,NLGEOM
*SENSITIVITY
...
```

or

```
*STEP,NLGEOM
```

```

*STATIC
...
*STEP,PERTURBATION
*FREQUENCY,STORAGE=YES
...
*STEP,NLGEOM
*SENSITIVITY
...

```

(a perturbation frequency step only makes sense with a preceding static step).

The output of a sensitivity calculation is stored as follows (frd-output only if the SEN output request was specified underneath a *NODE FILE card):

For TYPE=COORDINATE design variables the results of the target functions MASS, STRAIN ENERGY, EIGENFREQUENCY and ALL-DISP (i.e. the square root of the sum of the squares of the displacements in all objective nodes) are stored in the .frd-file and can be visualized using CalculiX GraphiX.

For TYPE=ORIENTATION design variables the eigenfrequency sensitivity is stored in the .dat file whereas the displacement sensitivity (i.e. the derivative of the displacements in all nodes w.r.t. the orientation) is stored in the .frd-file. The order of the design variables is listed in the .dat-file. All orientations defined by *ORIENTATION cards are varied, each orientation is defined by 3 independent variables. So for n *ORIENTATION cards there are 3n design variables. The sensitivity of the mass w.r.t. the orientation is zero.

Finally, it is important to know that a sensitivity analysis in CalculiX only works for true 3D-elements (no shells, beams, plane stress, etc...).

6.9.24 Feasible Direction

An optimization calculation usually consists of the minimization (or maximization) of one objective subject to one or more constraints. To that end the sensitivity of the objective is modified to take the constraint sensitivities into account leading to one combined sensitivity. This process takes place in a *FEASIBLE DIRECTION procedure. The ensuing sensitivity determines where the structure has to be thickened or thinned in order to reach a minimum of the objective function while not violating any constraint. Constraints can be taken into account by using the Gradient Projection Method or the Gradient Descent Method.

In the Gradient Projection Method the constraints are taken into account by projecting the unconstrained sensitivities on the complement of the subspace consisting of the normals on the active constraint hyperplanes. Suppose the domain is n-dimensional (n design variables) and the subspace has the dimension m (m constraints). Then the sensitivities of the constraints can be arranged as basis vectors (the normal directions on the hyperplanes) in a $n \times m$ matrix. The projection p of a vector b on the subspace satisfies the orthogonality condition:

$$N^T(b - p) = 0. \quad (803)$$

Since p belongs to the subspace it can be written as a linear combination of the basis vectors $p = Nx$, where x is a $m \times 1$ vector of coefficients. Consequently:

$$N^T Nx = N^T b, \quad (804)$$

from which x can be solved yielding:

$$p = N(N^T N)^{-1} N^T b. \quad (805)$$

The complement of the projection vector is $I - N(N^T N)^{-1} N^T$. Denoting $A = (N^T N)^{-1}$, the constrained sensitivities c are obtained from the unconstrained sensitivities b by:

$$c = (I - N A N^T) b, \quad (806)$$

or, in component notation:

$$c_i = b_i - \sum_k w_{ik}, \quad (807)$$

where

$$w_{ik} = \left(\sum_j N_{ij} A_{jk} \right) \left(\sum_l (N^T)_{kl} b_l \right) \quad (808)$$

(no summation over k in the last equation).

Active constraints are constraints which

- are fulfilled AND
- for which the Lagrange multiplier points to the non-feasible part of the space

To this end the algorithm starts with all constraints which are fulfilled and removes the constraints one-by-one for which the Lagrange multiplier, satisfying

$$\lambda = -(N^T N)^{-1} N^T \nabla g_i. \quad (809)$$

points to the feasible part of the space.

The Gradient Descent Method is an interior point method which means that the starting point for an optimization has to lie in the feasible domain. The influence of the constraints on the feasible direction is always taken into account independent of the distance to the constraint bound. This method aims to stay away from the constraint boundaries as long as possible on the way to the local optimum. The feasible direction is calculated with the following formulas (the detailed derivation can be found in [17]):

$$s_\xi = -\frac{\nabla f}{\|\nabla f\|} - \xi \frac{\nabla g}{\|\nabla g\|}. \quad (810)$$

Here, ∇f is the gradient of the objective function, ∇g is the gradient of the constraint and ξ is a value between 0 and 1 defining the weight of the constraint gradient on the descent direction. Choosing a value for ξ between 0.9 and 1.0 leads to meaningful results. By subtracting a portion of the gradient of the constraint one tends to stay away from the constraint boundary (the constraint becomes more negative). In case more than one constraint is defined, the assembly of the gradient vector of all constraint functions n is done using the logarithmic Barrier function:

$$\nabla g = \sum_{i=1}^n \frac{1}{-g_i(x)} \nabla g_i. \quad (811)$$

6.9.25 Robust Design

6.9.26 Green functions

With the *GREEN keyword card Green functions X_j can be calculated satisfying

$$[K - \omega_0^2 M] \cdot X_j = E_j, \quad (812)$$

where K is the stiffness matrix of the structure, M the mass matrix, ω_0 a scalar frequency and E_j a unit force at degree of freedom j . The degree of freedom j corresponds to a specific coordinate direction in a specific node. For $\omega_0 = 0$ the Green function is the static answer of a system to a unit force at some location in one of the global coordinate directions. Usually, these Green functions are used in subsequent calculations. The Green function procedure is a linear perturbation procedure, i.e. nonlinear behavior from a previous *STATIC step can be taken into account (through the appropriately modified stiffness matrix) using the PERTURBATION parameter on the *STEP card in the Green step.

The degrees of freedom in which a unit force is to be applied can be defined by use of the *CLOAD card (the force value specified by the user is immaterial, a unit value is taken). ω_0 is a parameter on the *CLOAD card.

If the input deck is stored in the file "problem.inp", where "problem" stands for any name, the Green functions, the stiffness matrix and the mass matrix are stored in binary form in a "problem.eig" file for further use (e.g. in a sensitivity step). Furthermore, the Green functions can be stored in the "problem.frd" file, using the standard *NODE FILE or *NODE OUTPUT card.

The sensitivity of the Green functions can be calculated in a subsequent *SENSITIVITY step in which the objective function is set to GREEN (cf. *OBJECTIVE).

Cyclic symmetry can be taken into account by use of the *CYCLIC SYMMETRY MODEL card to define the cyclic symmetry and the *SELECT CYCLIC SYMMETRY MODES

card to define the nodal diameters. This is analogous to frequency calculations with cyclic symmetry.

6.9.27 Crack propagation

In CalculiX a rather simple model to calculate cyclic crack propagation is implemented. In order to perform a crack propagation calculation the following procedure is to be followed:

- A static calculation (usually called a Low Cycle Fatigue = LCF calculation) for the uncracked structure (using volumetric elements) for one or more steps must have been performed and the results (at least stresses; if applicable, also the temperatures) must have been stored in a frd-file.
- Optionally a frequency calculation (usually called a High Cycle Fatigue = HCF calculation) for the uncracked structure has been performed and the results (usually stresses) have been stored in a frd-file.
- For the crack propagation itself a model consisting of at least all cracks to be considered meshed using S3-shell elements must be created. The orientation of all shell elements used to model one and the same crack should be consistent, i.e. when viewing the crack from one side of the crack shape all nodes should be numbered clockwise or all nodes should be numbered counterclockwise. Preferably, also the mesh of the uncracked structure should be contained (the crack propagation can be easier interpreted if the structure in which the crack propagates is also visualized) .
- The material parameters for the crack propagation law implemented in CalculiX must have been determined. Alternatively, the user may code his/her own crack propagation law in routine crackrate.f.
- The procedure *CRACK PROPAGATION must have been selected with appropriate parameters. Within the *CRACK PROPAGATION step the optional keyword card *HCF may have been selected.

In CalculiX, the following crack propagation law has been implemented:

$$\frac{da}{dN} = \left(\frac{da}{dN} \right)_{ref} \left(\frac{\Delta K}{\Delta K_{ref}} \right)^m \frac{f_{th} f_R}{f_c}, \quad (813)$$

where

$$\begin{aligned} f_{th} &= 1 - \exp \left[\epsilon \left(1 - \frac{\Delta K}{\Delta K_{th}} \right) \right], & \Delta K > \Delta K_{th} \\ f_{th} &= 0, & \Delta K \leq \Delta K_{th} \end{aligned} \quad (814)$$

accounts for the threshold range,

$$\begin{aligned}
 f_c &= 1 - \exp \left[\delta \left(\frac{K_{max}}{K_c} - 1 \right) \right], \quad K_{max} < K_c \\
 f_c &= 0 \quad K_{max} \geq K_c
 \end{aligned} \tag{815}$$

for the critical cut-off and

$$f_R = \left[\frac{1}{(1-R)^{1-w}} \right]^m \tag{816}$$

for the $R := K_{min}/K_{max}$ influence. The material constants have to be entered by using a *USER MATERIAL card with the following 8 constants per temperature data point (in that order): $\left(\frac{da}{dN}\right)_{ref} [L/cycle]$, $\Delta K_{ref} [F/L^{3/2}]$, $m[-]$, $\epsilon[-]$, $\Delta K_{th} [F/L^{3/2}]$, $\delta[-]$, $K_c [F/L^{3/2}]$ and $w[-]$, were $[F]$ is the unit of force and $[L]$ of length. Notice that the first part of the law corresponds to the Paris law. Indeed the classical Paris constant C can be obtained from:

$$\left(\frac{da}{dN}\right)_{ref} \left(\frac{1}{\Delta K_{ref}}\right)^m = C. \tag{817}$$

Vice versa, ΔK_{ref} can be obtained from C using the above equation once $(da/dN)_{ref}$ has been chosen. Notice that $(da/dN)_{ref}$ is the rate for which $\Delta K = \Delta K_{ref}$ (just considering the Paris range). For a user material, a maximum of 8 constants can be defined per line (cf. *USER MATERIAL). Therefore, after entering the 8 crack propagation constants, the corresponding temperature has to be entered on a new line.

The crack propagation calculation consists of a number of increments during which the crack propagates a certain amount. For each increment in a LCF calculation the following steps are performed:

- The actual shape of the cracks is analyzed, the crack fronts are determined and the stresses and temperatures (if applicable, else zero) at the crack front nodes are interpolated from the stress and temperature field in the uncracked structure.
- The stress tensor at the front nodes is projected on the local tangent plane yielding a normal component (local y-direction), a shear component orthogonal to the crack front (local x-direction) and one parallel to the crack front (local z-direction), leading to the K-factors K_I , K_{II} and K_{III} using the formulas:

$$K_I = F_I \sigma_{yy} \sqrt{\pi a} \tag{818}$$

$$K_{II} = F_{II} \sigma_{xy} \sqrt{\pi a} \tag{819}$$

$$K_{III} = F_{III} \sigma_{zy} \sqrt{\pi a} \quad (820)$$

where F_I , F_{II} and F_{III} are shape factors taking the form

$$F_I = F_{II} = F_{III} = 2/\pi \quad (821)$$

for subsurface cracks,

$$F_I = F_{II} = F_{III} = 2/\pi(1.04 + 1.1s^2), \quad -1 \leq s \leq 1 \quad (822)$$

for surface cracks spanning an angle $\geq \pi$ and

$$F_I = F_{II} = F_{III} = 1.12(1 - 0.02s^2), \quad -1 \leq s \leq 1 \quad (823)$$

for surface cracks spanning an angle of 0 (i.e. a one-sided crack in a two-dimensional plate). For an angle in between 0 and π the shape factors are linearly interpolated in between the latter two formulas. In the above formulas s is a local coordinate along the crack front, taking the values -1 and 1 at the free surface and 0 in the middle of the front. If the user prefers to use more detailed shape factors, user routine `crackshape.f` can be recoded.

- The crack length a in the above formulas is determined in two different ways, depending on the value of the parameter `LENGTH` on the `*CRACK PROPAGATION` card:
 - for `LENGTH=CUMULATIVE` the crack length is obtained by incrementally adding the crack propagation increments to the initial crack length. The initial length is determined using the `LENGTH=INTERSECTION` method.
 - for `LENGTH=INTERSECTION` a plane locally orthogonal to the crack front is constructed and subsequently a second intersection of this plane with the crack front is sought. The distance in between these intersection points is the crack length (except for a subsurface crack for which this length is divided by two). Notice that for intersection purposes the crack front for a surface crack is artificially closed by the intersection curve of the crack shape with the free surface in between the intersection points of the crack front.

Subsequently, the crack length is smoothed along the crack front according to:

$$a_j = \frac{\sum_{i=1}^N \left(1 - \frac{d_{ij}}{R}\right) a_i}{\sum_{i=1}^N \left(1 - \frac{d_{ij}}{R}\right)}, \quad (824)$$

where the sum is over the N closest nodes, d_{ij} is the Euclidean incremental distance between node i and j , and R is the distance between node j and the farthest of these nodes. N is a fixed fraction of the total number of nodes along the front, e.g. 90 %.

- From the stress factors an equivalent K-factor and deflection angle φ is calculated using a light modification of the formulas by Richard [80] in order to cope with negative K_I values as well:

$$K_{eq} = \text{sgn}(K_I)(|K_I| + \sqrt{K_I^2 + 5.3361K_{II}^2 + 4K_{III}^2})/2 \quad (825)$$

and

$$\varphi = -\frac{70\pi}{180} \left(\frac{|K_{II}|}{K_I + |K_{II}| + |K_{III}|} \right) \left(2 - \frac{|K_{II}|}{K_I + |K_{II}| + |K_{III}|} \right) \frac{K_{II}}{|K_{II}|} \quad (826)$$

for $K_I \geq 0$ and $\varphi = 0$ else. Subsequently, K_{eq} and φ are smoothed in the same way as the crack length. Finally, if any of the deflection angles exceeds the maximum defined by the user (second entry underneath the *CRACK PROPAGATION card) all values along the front are scaled appropriately.

Notice that at each crack front location as many K_{eq} and φ values are calculated as there are steps in the static calculation of the uncracked structure.

- The crack propagation increment for this increment is determined. It is the minimum of:
 - The user defined value (first entry underneath the *CRACK PROPAGATION card)
 - one fifth of the minimum crack front curvature
 - one fifth of the smallest crack length
- The crack propagation rate at every crack front location is determined. If there is only one step it results from the direct application of the crack propagation law with $\Delta K = K_{eq}$. For several steps the maximum minus the minimum of K_{eq} is taken. Notice that the crack rate routine is documented as a user subroutine: for missions consisting of several steps the user can define his/her own procedure for more complex procedures such as cycle extraction. The maximum value of da/dN across all crack front locations determines the number of cycles in this increment.
- For each crack front node the location of the propagated node is determined. This node lies in a plane locally orthogonal to the tangent vector along the front. To this end a local coordinate system is created (the same as for the calculation of K_I , K_{II} and K_{III}) consisting of:

- The local tangent vector \mathbf{t} .
 - The local normal vector obtained by the mean of the normal vectors on the shell elements to which the nodal front position belongs. This vector is subsequently projected into the plane normal to \mathbf{t} and normalized to obtain a vector \mathbf{n} .
 - a vector in the propagation direction $\mathbf{a} = \mathbf{t} \times \mathbf{n}$. This assumes that the tangent vector was such that the corkscrew rule points into direction \mathbf{n} when running along the crack front in direction \mathbf{t} .
- Then, new nodes are created in between the propagated nodes such that they are equidistant. The target distance in between these nodes is the mean distance in between the nodes along the initial crack front.
 - Finally, new shell elements are generated covering the crack propagation increment and the results (K-values, crack length etc.) are stored in frd-format for visualization. Then, a new increment can start. The number of increments is governed by the INC parameter on the *STEP card.

For a combined LCF-HCF calculation, triggered by the *HCF keyword in the *CRACK PROPAGATION procedure the picture is slightly more complicated. On the *HCF card the user defines a scaling factor and a step from the static calculation on which the HCF loading is to be applied. This is usually the static loading at which the modal excitation occurs. At this step a HCF cycle is considered consisting of the LCF+HCF and the LCF-HCF loading. The effect is as follows:

- If this cycle leads to propagation and HCF propagation is not allowed (MAX CYCLE= 0 on the *HCF card; this is default) the program stops with an appropriate error message.
- If it leads to propagation and HCF propagation is allowed (MAX CYCLE > 0 on the *HCF card) the number of cycles is determined to reach the desired crack propagation in this increment and the next increment is started. No LCF propagation is considered in this increment.
- If it does not lead to HCF propagation, LCF propagation is considered for the static loading in which the LCF loading of the step to which HCF applies is replaced by LCF+HCF loading. The propagation is calculated as usual.

The output of a *CRACK PROPAGATION step is selected by using the parameter KEQ on the *NODE FILE card. Then, a data set is created in the frd-file consisting of the following information (most of this information can be changed in user subroutine crackrate.f):

- The dominant step. This is the step with the largest K_{eq} (over all steps). If the dominant step is a HCF induced step, step numbers -1 and -2 are used to denominate the LCF-HCF step and the LCF+HCF step, respectively.

- DeltaKEQ: the value of ΔK_{eq} for the main cycle. In the present implementation this corresponds to the largest value of K_{eq} (over all steps).
- KEQMIN: the minimal value of K_{eq} (over all steps).
- KEQMAX: the largest value of K_{eq} (over all steps).
- K1WORST: the largest value of $|K_I|$ multiplied by its sign (over all steps).
- K2WORST: the largest value of $|K_{II}|$ multiplied by its sign (over all steps).
- K3WORST: the largest value of $|K_{III}|$ multiplied by its sign (over all steps).
- PHI: the deflection angle φ .
- R: the R-value of the main cycle. In the present implementation this is zero.
- DADN: the crack propagation rate.
- KTH: not used.
- INC: the increment number. This is the same for all nodes along one and the same crack front.
- CYCLES: the number of cycles since the start of the calculation. This number is common to all crack front nodes.
- CRLENGTH: crack length.
- DOM_SLIP: not used

Since the jobname.frd file is created from scratch in every *CRACK PROPAGATION step (this is because every *CRACK PROPAGATION step changes the number of nodes and elements in the model due to the growing crack) it does not make sense to have more than one such step in an input deck. In fact, any other step is senseless and ideally the *CRACK PROPAGATION step should be the only step in the deck. If the user defines more than one *CRACK PROPAGATION step in his/her input deck, the jobname.frd file will only contain the output requested, if any, from the last *CRACK PROPAGATION step. This rule also applies to restart calculations.

6.10 Convergence criteria

6.10.1 Thermomechanical iterations

To find the solution at the end of a given increment a set of nonlinear equations has to be solved. In order to do so, the Newton-Raphson method is used, i.e. the set of equations is locally linearized and solved. If the solution does not satisfy the original nonlinear equations, the latter are again linearized at

the new solution. This procedure is repeated until the solution satisfies the original nonlinear equations within a certain margin. Suppose iteration i has been performed and convergence is to be checked. Let us introduce the following quantities:

- \bar{q}_i^α : the average flux for field α at the end of iteration i . It is defined by:

$$\bar{q}_i^\alpha = \frac{\sum_e \sum_{n_e} \sum_{k_n} |q_i^\alpha|}{\sum_e \sum_{n_e} k_n^\alpha} \quad (827)$$

where e represents all elements, n_e all nodes belonging to a given element, k_n all degrees of freedom for field α belonging to a given node and q_i^α is the flux for a given degree of freedom of field α in a given node belonging to a given element at the end of iteration i . Right now, there are two kind of fluxes in CalculiX: the force for mechanical calculations and the concentrated heat flux for thermal calculations.

- \tilde{q}_i^α : the iteration-average of the average flux for field α of all iterations in the present increment up to but not including iteration i .
- $r_{i,max}^\alpha$: the largest residual flux (in absolute value) of field α at the end of iteration i . For its calculation each degree of freedom is considered independently from all others:

$$r_{i,max}^\alpha = \max_{DOF} |\delta q_i^\alpha|, \quad (828)$$

where δ denotes the change due to iteration i .

- $\Delta u_{i,max}^\alpha$: the largest change in solution (in absolute value) of field α in the present increment, i.e. the solution at the end of iteration i of the present increment minus the solution at the start of the increment :

$$\Delta u_{i,max}^\alpha = \max_e \max_{n_e} \max_{k_n} |\Delta u_i^\alpha|, \quad (829)$$

where Δ denotes the change due to the present increment. In mechanical calculations the solution is the displacement, in thermal calculations it is the temperature.

- $c_{i,max}^\alpha$: the largest change in solution (in absolute value) of field α in iteration i :

$$c_{i,max}^\alpha = \max_e \max_{n_e} \max_{k_n} |\delta u_i^\alpha|. \quad (830)$$

Now, two constants c_1 and c_2 are introduced: c_1 is used to check convergence of the flux, c_2 serves to check convergence of the solution. Their values depend on whether zero flux conditions prevail or not. Zero flux is defined by

$$\bar{q}_i^\alpha \leq \epsilon^\alpha \tilde{q}_i^\alpha. \quad (831)$$

The following rules apply:

- if ($\bar{q}_i^\alpha > \epsilon^\alpha \tilde{q}_i^\alpha$) (no zero flux):
 - if ($i \leq I_p[9]$) $c_1 = R_n^\alpha[0.005]$, $c_2 = C_n^\alpha[0.02]$.
 - else $c_1 = R_p^\alpha[0.02]$, $c_2 = C_n^\alpha[0.02]$.
- else (zero flux) $c_1 = \epsilon^\alpha[10^{-5}]$, $c_2 = C_\epsilon^\alpha[0.001]$

The values in square brackets are the default values. They can be changed by using the keyword card *CONTROLS. Now, convergence is obtained if

$$r_{i,max}^\alpha \leq c_1 \tilde{q}_i^\alpha \quad (832)$$

AND if, for thermal or thermomechanical calculations (*HEAT TRANSFER, *COUPLED TEMPERATURE-DISPLACEMENT or *UNCOUPLED TEMPERATURE-DISPLACEMENT), the temperature change does not exceed DELTMX,

AND at least one of the following conditions is satisfied:

- $c_{i,max}^\alpha \leq c_2 \Delta u_{i,max}^\alpha$

-

$$\frac{r_{i,max}^\alpha c_{i,max}^\alpha}{\min\{r_{i-1,max}^\alpha, r_{i-2,max}^\alpha\}} < c_2 \Delta u_{i,max}^\alpha. \quad (833)$$

The left hand side is an estimate of the largest solution correction in the next iteration. This condition only applies if no gas temperatures are to be calculated (no forced convection).

- $r_{i,max}^\alpha \leq R_l^\alpha[10^{-8}] \tilde{q}_i^\alpha$. If this condition is satisfied, the increment is assumed to be linear and no solution convergence check is performed. This condition only applies if no gas temperatures are to be calculated (no forced convection).
- $\bar{q}_i^\alpha \leq \epsilon^\alpha[10^{-5}] \tilde{q}_i^\alpha$ (zero flux conditions). This condition only applies if no gas temperatures are to be calculated (no forced convection).
- $c_{i,max}^\alpha < 10^{-8}$.

If convergence is reached, and the size of the increments is not fixed by the user (no parameter DIRECT on the *STATIC, *DYNAMIC or *HEAT TRANSFER card) the size of the next increment is changed under certain circumstances:

- if ($i > I_L[10]$): $d\theta = d\theta D_B[0.75]$, where $d\theta$ is the increment size relative to the step size (convergence was rather slow and the increment size is decreased).

- if ($i \leq I_G[4]$) AND the same applies for the previous increment: $d\theta = d\theta D_D[1.5]$ (convergence is fast and the increment size is increased).

If no convergence is reached in iteration i , the following actions are taken:

- if, for thermomechanical calculations, the temperature change exceeds DELTMX, the size of the increment is multiplied by $\frac{\text{DELTMX}}{\text{temperature change}} D_A [0.85]$.
- if $i > I_C[16]$, too many iterations are needed to reach convergence and any further effort is abandoned: CalculiX stops with an error message.
- if $i \geq I_0[4]$ AND $|r_{i,max}^\alpha| > 10^{-20}$ AND $|c_{i,max}^\alpha| > 10^{-20}$ AND $r_{i-1,max}^\alpha > r_{i-2,max}^\alpha$ AND $r_{i,max}^\alpha > r_{i-2,max}^\alpha$ AND $r_{i,max}^\alpha > c_1 \tilde{q}_i^\alpha$ then:
 - if the parameter DIRECT is active, the solution is considered to be divergent and CalculiX stops with an error message.
 - else, the size of the increment is adapted according to $d\theta = d\theta D_F[0.25]$ and the iteration of the increment is restarted.
- if $i \geq I_R[8]$, the number of iterations x is estimated needed to reach convergence. x roughly satisfies:

$$r_{i,max}^\alpha \left(\frac{r_{i,max}^\alpha}{r_{i-1,max}^\alpha} \right)^x = R_n^\alpha \tilde{q}_i^\alpha \quad (834)$$

from which x can be determined. Now, if

$$i + \frac{\ln \left(R_n^\alpha \frac{\tilde{q}_i^\alpha}{r_{i,max}^\alpha} \right)}{\ln \left(\frac{r_{i,max}^\alpha}{r_{i-1,max}^\alpha} \right)} > I_C[16] \quad (835)$$

(which means that the estimated number of iterations needed to reach convergence exceeds I_C) OR $i = I_C$, the increment size is adapted according to $d\theta = d\theta D_C[0.5]$ and the iteration of the increment is restarted unless the parameter DIRECT was selected. In the latter case the increment is not restarted and the iterations continue.

- if none of the above applies iteration continues.

6.10.2 Contact

In the presence of contact the convergence conditions in the previous section are slightly modified. Let us first repeat the general convergence check strategy (coded in checkconvergence.c):

- If, at the end of an iteration, convergence is detected then:

- a new increment is started (unless the step is finished)
- it is checked whether the size of this increment has to be decreased w.r.t. the present increment size (slow convergence) or can be increased (fast convergence)
- else (no convergence detected)
 - it is checked whether the number of allowable iterations has been reached, if so the program stops
 - it is checked whether divergence occurred in the following order:
 - * due to non-convergence in a material user subroutine
 - * the force residual is larger than in the previous iteration AND larger than in the iteration before the previous iteration (only done after I_0 iterations). Let us call this check the major divergence check.
 - * due to the violation of a user-defined limit (e.g. temperature change limit, viscous strain limit)
 - if divergence is detected then
 - * if the increment size is fixed by the user the program stops
 - * else a new increment is started with a smaller size (unless the size is smaller than a user-defined quantity, in which case the program stops)
 - if no divergence is detected then a check is performed for too slow convergence. If this is the case then
 - * if the increment size is fixed by the user the program stops
 - * else a new increment is started with a smaller size (unless the size is smaller than a user-defined quantity, in which case the program stops)
 - if no divergence is detected and the convergence is not too slow the next iteration is started.

In the case penalty contact was defined an additional parameter `iflagact` is defined expressing whether the number of contact elements changed significantly between the present and the previous iteration. In the latter case `iflagact=1`, else it takes the value zero (default). Whether a change is significantly or not is governed by the value of the parameter `delcon`, which the user can define underneath a `*CONTROLS,PARAMETERS=CONTACT` card (default is 0.001, i.e. 0.1 %).

Now, in the case of node-to-face penalty contact the standard convergence check algorithm is modified as follows:

- If `iflagact=1` at the end of the present iteration the counter for I_0 and I_R is reset to zero and the value of I_C is incremented by 1.

- Mechanical convergence requires iflagact to be zero.

In the case of face-to-face penalty contact the criteria are modified as follows:

- Mechanical convergence requires iflagact to be zero.
- If convergence occurred the check whether the next increment must be decreased is not done
- If no convergence occurred then
 - the check whether the number of allowable iterations has been reached is not done
 - the major divergence check (see above) is only done if one of the following conditions is satisfied:
 - * the present force residual exceeds 1.e9
 - * iflagact is zero (no significant change in contact elements). If, in this case, the major divergence check points to divergence and the solution condition $c_{i,max}^\alpha \leq c_2 \Delta u_{i,max}^\alpha$ is satisfied the aleatoric flag is set to 1. Physically, this means that the force residuals are increasing although the displacement solution does not change much, i.e. a local minimum has been reached. In order to leave this minimum a percentage of the contacts (default: 10 %; can be changed with the *CONTROLS,PARAMETERS=CONTACT card) is removed in an aleatoric way in order to stir the complete structure.
 - * the number of contact elements is oscillating since the last two iterations (e.g. the number of contact elements increased in the present iteration but decreased in the previous one or vice versa) and there is no significant change in the sum of the residual force in the present and previous iteration (compared to the sum of the residual force in the previous iteration and the one before the previous iteration). Physically this means that solution is alternating between two states.
 - if divergence is detected not only the time increment is decreased, also the spring stiffness in case of linear pressure-overclosure and the stick slope are reduced by a factor of 100 (this number can be changed with the *CONTROLS,PARAMETERS=CONTACT card). This factor (variable “kscale” in the code) is reset to one at the next convergence detection in which case the iteration is continued until renewed successful convergence for kscale=1.
 - the too slow convergence check is replaced by a check whether the number of iterations has reached the value of 60 (this number can be changed with the *CONTROLS,PARAMETERS=CONTACT card). In that case the spring stiffness in case of linear pressure-overclosure and the stick slope are reduced by a factor of 100 (this number can be

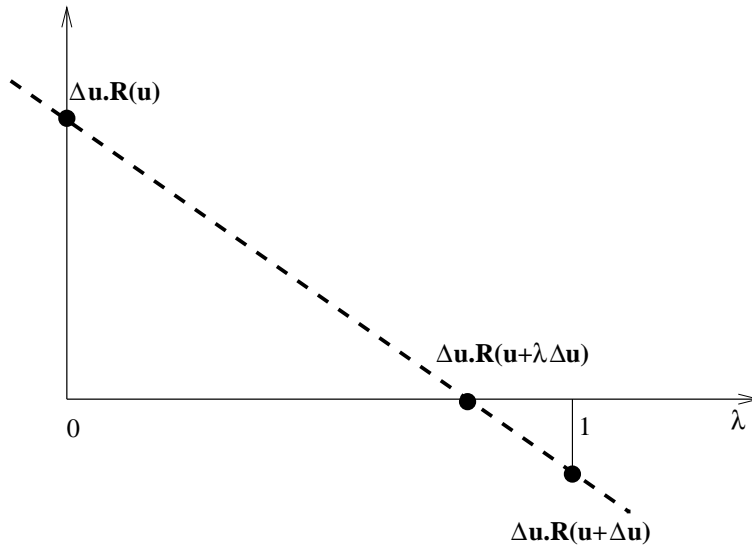

Figure 153: Principle of the line search method

changed with the *CONTROLS,PARAMETERS=CONTACT card). This factor (variable “kscale” in the code) is reset to one at the next convergence detection in which case the iteration is continued until renewed successful convergence for kscale=1). The time increment is NOT decreased, unless this is already the second cutback or higher.

6.10.3 Line search

In the case of static calculations with face-to-face penalty contact the displacement increment $\Delta \mathbf{u}$ in each iteration is scaled with a scalar λ in order to get better convergence. λ is determined such that the residual (i.e. external force minus internal force) of the scaled solution $\mathbf{u} + \lambda \Delta \mathbf{u}$ is orthogonal to the displacement increment:

$$\Delta \mathbf{u} \cdot \mathbf{R}(\mathbf{u} + \lambda \Delta \mathbf{u}) = 0. \quad (836)$$

Now, the residual for $\lambda = 0$ is known from the previous increment, and the residual for $\lambda = 1$ is known from the present increment. In between a linear relationship is assumed (cf. Figure 153), which yields the value of λ without extra calculations. With the *CONTROLS card the user can specify a value for λ_{\min} (default: 0.25) and λ_{\max} (default: 1.01).

6.10.4 Network iterations

For network iterations two kinds of convergence criteria are applied: the residuals and the change in the solution must be both small enough.

For the mass and energy flow residuals \tilde{q}_i^α and $r_{i,max}^\alpha$ are calculated as specified in Equations (827) and (828) with $k_n = 1$ and q_i^α equal to the mass flow (unit of mass/unit of time) and the energy flow (unit of energy/unit of time). For the element equation \tilde{q}_i^α is taken to be 1 (the element equation is dimensionless) and $r_{i,max}^\alpha$ is calculated based on the element equation residuals. The residual check amounts to

$$r_{i,max}^\alpha \leq c_{1*} \tilde{q}_i^\alpha \quad (837)$$

where c_{1*} takes the value c_{1t} , c_{1f} and c_{1p} for the energy balance, mass balance and element equation, respectively. In addition, an absolute check can be performed in the form

$$r_{i,max}^\alpha \leq a_{1*} \quad (838)$$

where a_{1*} takes the value a_{1t} , a_{1f} and a_{1p} for the energy balance, mass balance and element equation, respectively. Default is to deactivate the absolute check (the coefficients a_{1*} are set to 10^{20}).

In the same way the maximum change in solution in network iteration i $c_{i,max}^\alpha$ is compared with the maximum change in the solution since the start of the network iterations, i.e. the solution at the end of iteration i minus the solution at the beginning of the increment (before network iteration 1). This is done separately for the temperature, the mass flow, the pressure and the geometry. It amounts to the equation:

$$c_{i,max}^\alpha \leq c_{2*} \Delta u_{i,max}^\alpha, \quad (839)$$

where c_{2*} takes the value c_{2t} , c_{2f} , c_{2p} and c_{2a} for the temperature, the mass flow, the pressure and the geometry, respectively. In addition, an absolute check can be performed in the form

$$c_{i,max}^\alpha \leq a_{2*}, \quad (840)$$

where a_{2*} takes the value a_{2t} , a_{2f} and a_{2p} for the temperature, the mass flow, the pressure and the geometry. Default is to deactivate the absolute check (the coefficients a_{2*} are set to 10^{20}).

The parameters c_{1t} , c_{1f} , c_{1p} , c_2 , c_{2f} , c_{2p} , c_{2a} and a_{1t} , a_{1f} , a_{1p} , a_2 , a_{2f} , a_{2p} , a_{2a} can be changed using the *CONTROLS,PARAMETERS=NETWORK card.

Both criteria are important. A convergent solution with divergent residuals points to a local minimum, convergent residuals with a divergent solution point to a singular equation system (i.e. infinitely many solutions).

6.10.5 Implicit dynamics

In CalculiX, implicit dynamics is implemented using the α -method [23]. The method is unconditionally stable and second order accurate. The parameter $\alpha \in [-1/3, 0]$ represents high frequency damping. The lower the value, the

more high frequency dissipation is introduced. This is frequently desired in order to reduce noise. However, it also leads to energy loss.

An analysis has shown that the usual static convergence criteria have to be supplemented by energy criteria in order to obtain good results. To this end, the relative energy balance is used defined by:

$$\hat{r}_e = \frac{\Delta\mathcal{E}(t_n) + \Delta\mathcal{K}(t_n) + \Delta\mathcal{E}_c(t_n) - W_{\text{ext}}|_{t_0}^{t_n} - W_{\text{damp}}|_{t_0}^{t_n}}{\max_{t \in [t_0, t_n]} (|\Delta\mathcal{E}(t)|, |\mathcal{K}(t)|, |W_{\text{ext}}(t)|)}, \quad (841)$$

where

- t_0 is the time at the beginning of the present step
- t_n is the actual step time
- Δ denotes the difference of a quantity between the actual time and the time at the beginning of the step
- \mathcal{E} is the internal energy
- \mathcal{K} is the kinetic energy
- \mathcal{E}_c is the contact spring energy
- $W_{\text{ext}}|_{t_0}^{t_n}$ is the external work done since the start of the present step
- $W_{\text{damp}}|_{t_0}^{t_n}$ is the work done by damping since the start of the present step (always negative)
- in the denominator the choice of the kinetic energy versus the CHANGE of the internal energy is on purpose.

At the start of the step the relative energy balance is zero. During the step it usually decreases (becomes negative) and increases in size. Limiting the relative energy decay at the end of the step to ϵ , during the step the following minimum energy decay function is proposed:

$$\hat{r}_e^{\min} = -\frac{\epsilon}{2}(1 + \sqrt{\theta}), \quad (842)$$

where θ is the relative step time, $0 \leq \theta \leq 1$. The following algorithm is now used:

If

$$\hat{r}_e \leq -\frac{\epsilon}{2}(1 + \sqrt{\theta}), \quad (843)$$

the increment size is decreased. Else if

$$\hat{r}_e \leq -0.9\frac{\epsilon}{2}(1 + \sqrt{\theta}), \quad (844)$$

the increment size is kept. Else it is increased.

In dynamic calculations contact is frequently an important issue. As soon as more than one body is modeled they may and generally will come into contact. In CalculiX penalty contact is implemented by the use of springs, either in a node-to-face version or in a face-to-face version (face-to-face mortar contact is only available for static procedures). A detailed analysis of contact phenomena in dynamic calculations [71] has revealed that there are three instances at which energy may be lost: at the time of impact, during persistent contact and at the time of rebound.

At the time of impact a relative energy decrease has been observed, whereas at the time of rebound a relative energy increase occurs. The reason for this is the finite time increment during which impact or rebound takes place. During closed contact the contact forces do not perform any work (they are equal and opposite and are subject to a common motion). However, in the increment during which impact or rebound occurs, they do perform work in the part of the increment during which the gap is not closed. The more precise the time of impact coincides with the beginning or end of an increment, the smaller the error. Therefore, the following convergence criteria are proposed:

At impact the relative energy decrease (after impact minus before impact) should not exceed 0.008, i.e.

$$\Delta \hat{r}_{\text{rel}} \Big|_{\text{before impact}}^{\text{after impact}} \geq -0.008, \quad (845)$$

else the increment size is decreased by a factor of 4.

At rebound the relative energy increase between the time of rebound and the time of impact should not exceed 0.0025, i.e.

$$\Delta \hat{r}_{\text{rel}} \Big|_{\text{impact}}^{\text{rebound}} \leq -0.0025, \quad (846)$$

else the increment size is decreased by a factor of 2.

In between impact and rebound (persistent contact) both the impact criterion as well as the rebound criterion has to be satisfied. Furthermore it has been observed that during contact frequently vibrations are generated corresponding to the eigenfrequency of the contact springs. Due to the high frequency damping characteristics of the α -method this contributes additionally to a decay of the relative energy. To avoid this, the time increment should ideally exceed the period of these oscillations substantially,

$$\frac{10T_e}{T_{\text{step}}} \leq d\theta \leq \frac{100T_e}{T_{\text{step}}} \quad (847)$$

is aimed at, where T_e is the period of the oscillations, T_{step} is the duration of the step and $d\theta$ is the relative increment size.

6.11 Loading

All loading, except residual stresses, must be specified within a step. Its magnitude can be modified by a time dependent amplitude history using the *AMPLITUDE

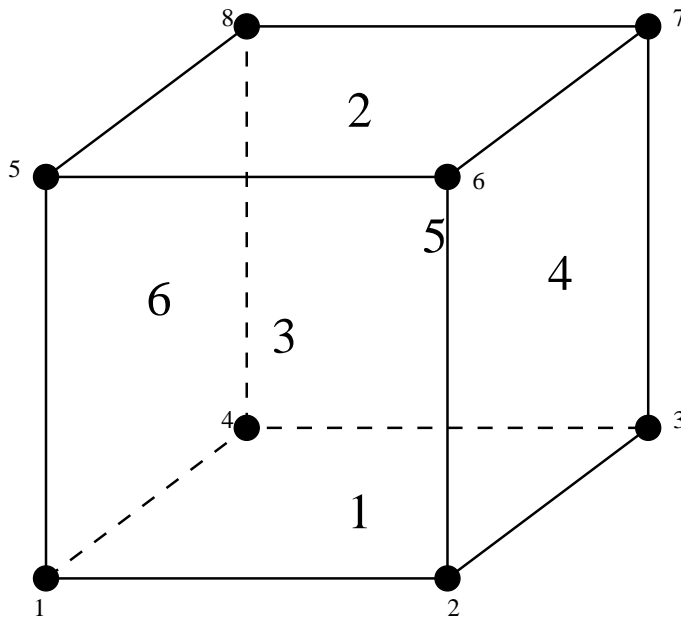

Figure 154: Face numbering for hexahedral elements

keyword. This makes sense for nonlinear static, nonlinear dynamic, modal dynamic and steady state dynamics procedures only. Default loading history is a ramp function for *STATIC procedures and step loading for *DYNAMIC and *MODAL DYNAMIC procedures.

6.11.1 Point loads

Point loads are applied to the nodes of the mesh by means of the *CLOAD keyword. Applying a point load at a node in a direction for which a point load was specified in a previous step replaces this point load, otherwise it is added. The parameter OP=NEW on the *CLOAD card removes all previous point loads. It takes only effect for the first *CLOAD card in a step. A buckling step always removes all previous loads.

6.11.2 Facial distributed loading

Distributed loading is triggered by the *DLOAD card. Facial distributed loads are entered as pressure loads on the element faces, which are for that purpose numbered according to Figures 154, 155 and 156.

Thus, for hexahedral elements the faces are numbered as follows:

- Face 1: 1-2-3-4
- Face 2: 5-8-7-6

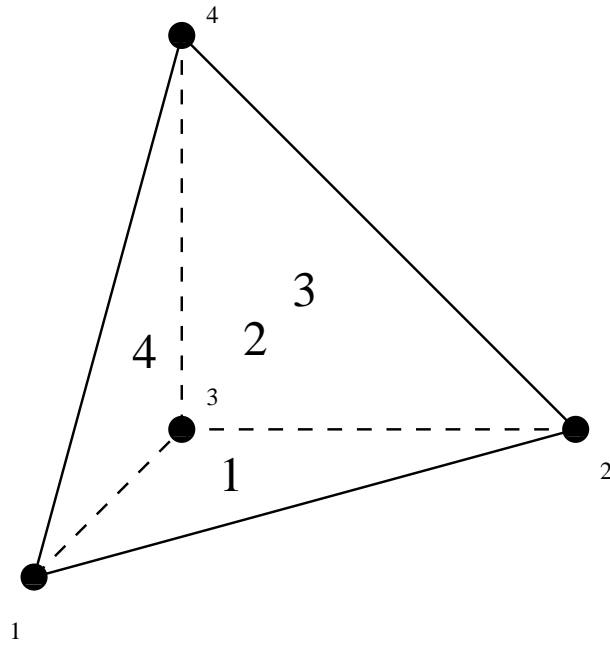

Figure 155: Face numbering for tetrahedral elements

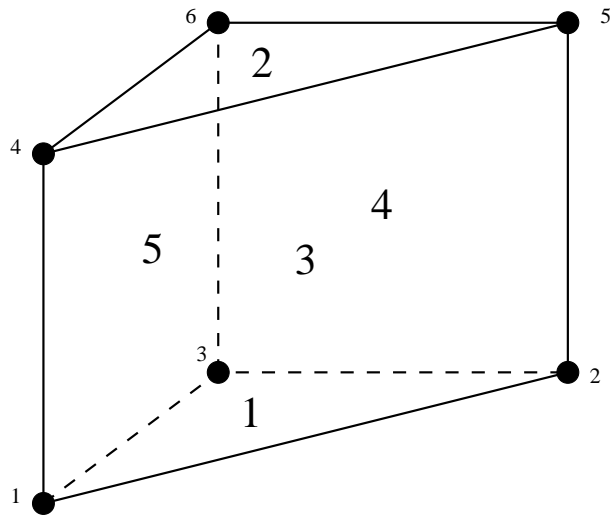

Figure 156: Face numbering for wedge elements

- Face 3: 1-5-6-2
- Face 4: 2-6-7-3
- Face 5: 3-7-8-4
- Face 6: 4-8-5-1

for tetrahedral elements:

- Face 1: 1-2-3
- Face 2: 1-4-2
- Face 3: 2-4-3
- Face 4: 3-4-1

for wedge elements:

- Face 1: 1-2-3
- Face 2: 4-5-6
- Face 3: 1-2-5-4
- Face 4: 2-3-6-5
- Face 5: 3-1-4-6

for quadrilateral plane stress, plane strain and axisymmetric elements:

- Face 1: 1-2
- Face 2: 2-3
- Face 3: 3-4
- Face 4: 4-1

for triangular plane stress, plane strain and axisymmetric elements:

- Face 1: 1-2
- Face 2: 2-3
- Face 3: 3-1

for beam elements:

- Face 1: pressure in 1-direction
- Face 2: pressure in 2-direction

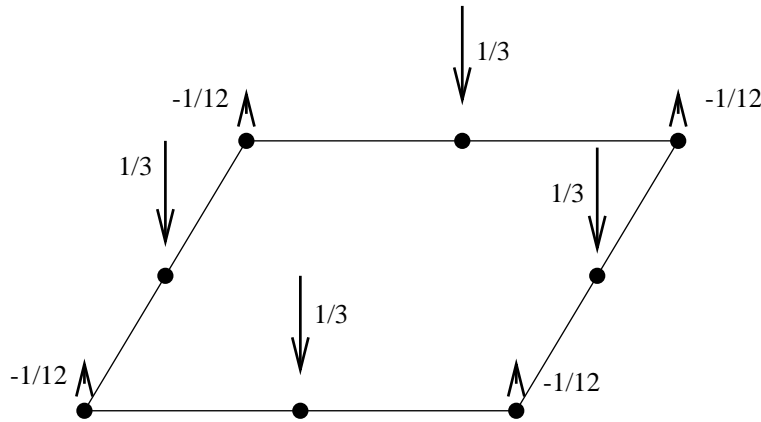

Figure 157: Equivalent nodal forces for a face of a C3D20(R) element

For shell elements no face number is needed since there is only one kind of loading: pressure in the direction of the normal on the shell.

Applying a pressure to a face for which a pressure was specified in a previous step replaces this pressure. The parameter `OP=NEW` on the `*DLOAD` card removes all previous distributed loads. It only takes effect for the first `*DLOAD` card in a step. A buckling step always removes all previous loads.

In a large deformation analysis the pressure is applied to the deformed face of the element. Thus, if you pull a rod with a constant pressure, the total force will decrease due to the decrease of the cross-sectional area of the rod. This effect may or may not be intended. If not, the pressure can be replaced by nodal forces. Figures 157 and 158 show the equivalent forces for a unit pressure applied to a face of a C3D20(R) and C3D10 element. Notice that the force is zero (C3D10) or has the opposite sign (C3D20(R)) for quadratic elements. For the linear C3D8(R) elements, the force takes the value $1/4$ in each node of the face.

6.11.3 Centrifugal distributed loading

Centrifugal loading is selected by the `*DLOAD` card, together with the `CENTRIF` label. Centrifugal loading is characterized by its magnitude (defined as the rotational speed square ω^2) and two points on the rotation axes. To obtain the force per unit volume the centrifugal loading is multiplied by the density. Consequently, the material density is required. The parameter `OP=NEW` on the `*DLOAD` card removes all previous distributed loads. It only takes effect for the first `*DLOAD` card in a step. A buckling step always removes all previous loads.

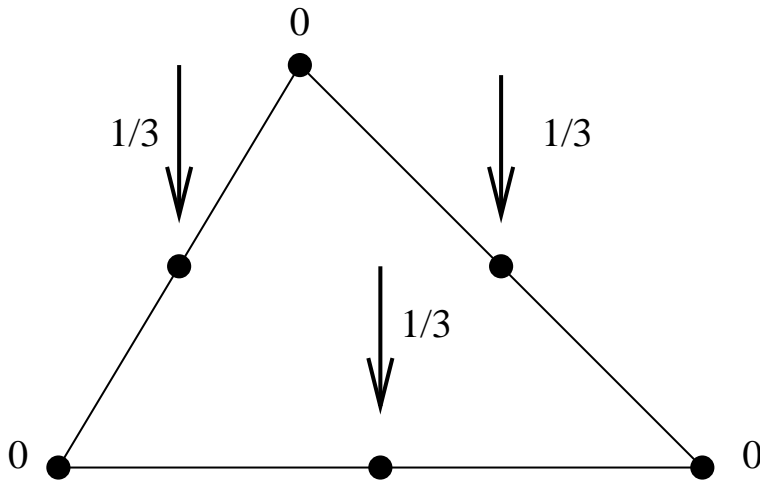

Figure 158: Equivalent nodal forces for a face of a C3D10 element

6.11.4 Gravity distributed loading

Gravity loading with known gravity vector is selected by the *DLOAD card, together with the GRAV label. It is characterized by the vector representing the acceleration. The material density is required. Several gravity load cards can appear in one and the same step, provided the element set and/or the direction of the load varies (else, the previous gravity load is replaced). The parameter OP=NEW on the *DLOAD card removes all previous distributed loads. It only takes effect for the first *DLOAD card in a step. A buckling step always removes all previous loads.

General gravity loading, for which the gravity vector is calculated by the momentaneous mass distribution is selected by the *DLOAD card, together with the NEWTON label. For this type of loading to make sense all elements must be assigned a NEWTON type label loading, since only these elements are taken into account for the mass distribution calculation. This type of loading requires the material density (*DENSITY) and the universal gravitational constant (*PHYSICAL CONSTANTS). It is typically used for the calculation of orbits and automatically triggers a nonlinear calculation. Consequently, it can only be used in the *STATIC, *VISCO, *DYNAMIC or *COUPLED TEMPERATURE-DISPLACEMENT step and not in a *FREQUENCY, *BUCKLE, *MODAL DYNAMIC or *STEADY STATE DYNAMICS step. It's use in a *HEAT TRANSFER step is possible, but does not make sense since mechanical loading is not taken into account in a pure heat transfer analysis.

6.11.5 Forces obtained by selecting RF

This section has been included because the output when selecting RF on a *NODE PRINT, *NODE FILE or *NODE OUTPUT card is not always what

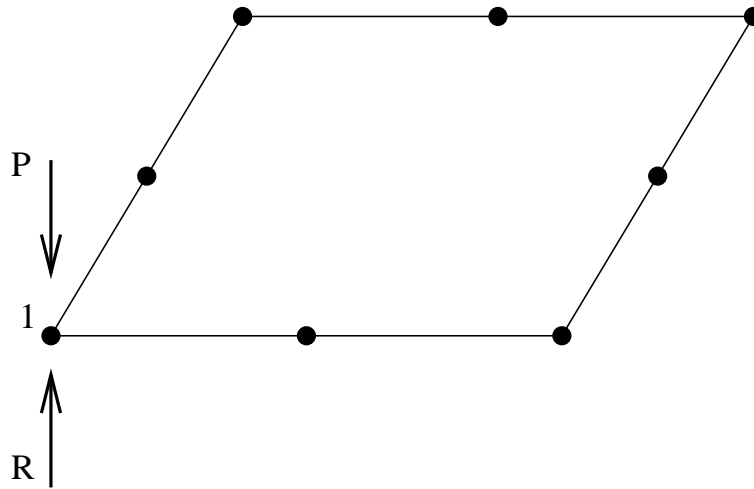

Figure 159: Point load in a node belonging to a 8-noded face

the user expects. With RF you get the sum of all external forces in a node. The external forces can be viewed as the sum of the loading forces and the reaction forces. Let us have a look at a couple of examples:

Figure 159 represents the upper surface of a plate of size $1 \times 1 \times 0.1$, modeled by just one C3D20R element. Only the upper face of the element is shown. Suppose the user has fixed all nodes belonging to this face in loading direction. In node 1 an external point loading is applied of size P . Since this node is fixed in loading direction, a reaction force of size $R=P$ will arise. The size of the total force, i.e. the point loading plus the reaction force is zero. This is what the user will get if RF is selected for this node.

Figure 160 shows the same face, but now the upper surface is loaded by a pressure of size 1. Again, only one C3D20R element is used and the equivalent point forces for the pressure load are as shown. We assume that all nodes on the border of the plate are fixed in loading direction (in this case this means all nodes, since all nodes are lying on the border). Therefore, in each node a reaction force will arise equal to the loading force. Again, the total force in each node is zero, which is the value the user will get by selecting RF on the *NODE PRINT, *NODE FILE or *NODE OUTPUT card.

Now, the plate is meshed with 4 quadratic elements. Figure 161 shows a view from above. All borders of the plate are fixed and the numbers at the nodes represent the nodal forces corresponding to the uniform pressure of size 1. Suppose the user would like to know the sum of the external forces at the border nodes (e.g. by selecting RF on a *NODE PRINT card with parameter TOTALS=ONLY). The external forces are the sum of the reaction forces and the loading forces. The total reaction force is -1. The loading forces at the border nodes are the non-circled ones in Figure 161, summing up to $5/12$. Consequently the sum of the external forces at the border nodes is $-7/12$.

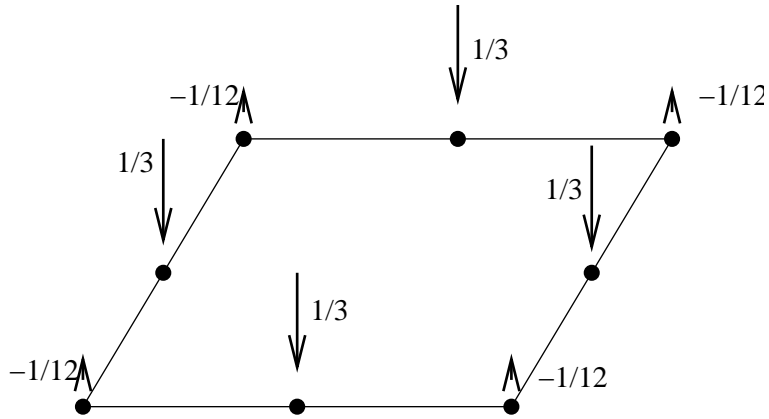

Figure 160: Equivalent forces of a uniform pressure on a plate (1 element)

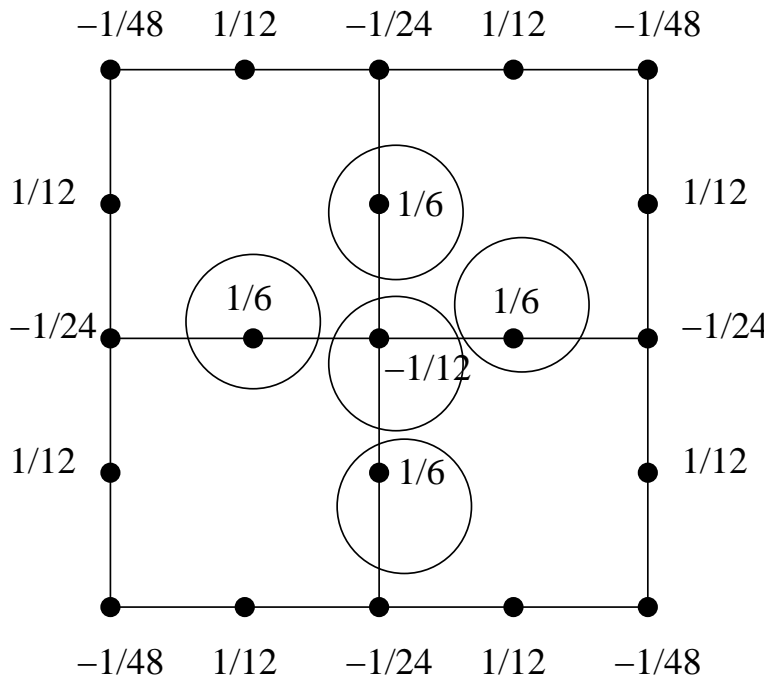

Figure 161: Equivalent forces of a uniform pressure on a plate (4 elements)

By selecting an even finer mesh the sum of the external forces at the border nodes will approach -1.

Summarizing, selecting RF gives you the sum of the reaction forces and the loading forces. This is equal to the reaction forces only if the elements belonging to the selected nodes are not loaded by a *DLOAD card, and the nodes themselves are not loaded by a *CLOAD card.

6.11.6 Temperature loading in a mechanical analysis

Temperature loading is triggered by the keyword *TEMPERATURE. Specification of initial temperatures (*INITIAL CONDITIONS, TYPE=TEMPERATURE) and expansion coefficients (*EXPANSION) is required. The temperature is specified at the nodes. Redefined temperatures replace existing ones.

6.11.7 Initial(residual) stresses

In each integration point of an element a residual stress tensor can be specified by the keyword *INITIAL CONDITIONS, TYPE=STRESS. The residual stress should be defined before the first *STEP card.

6.11.8 Concentrated heat flux

Concentrated heat flux can be defined in nodes by using the *CFLUX card. The units are those of power, flux entering the body is positive, flux leaving the body is negative.

6.11.9 Distributed heat flux

Distributed heat flux can be defined on element sides by using the *DFLUX card. The units are those of power per unit of area, flux entering the body is positive, flux leaving the body is negative. Nonuniform flux can be defined by using the subroutine dflux.f.

In the absence of a *DFLUX card for a given element face, no distributed heat flux will be applied to this face. This seems reasonable, however, this only applies to solid structures. Due to the iterative way in which fluid dynamics calculations are performed an external element face in a CFD calculation exhibits no heat flux only if a *DFLUX card was defined for this surface with a heat flux value of zero.

6.11.10 Convective heat flux

Convective heat flux is a flux depending on the temperature difference between the body and the adjacent fluid (liquid or gas) and is triggered by the *FILM card. It takes the form

$$q = h(T - T_0) \quad (848)$$

where q is the a flux normal to the surface, h is the film coefficient, T is the body temperature and T_0 is the environment fluid temperature (also called sink temperature). Generally, the sink temperature is known. If it is not, it is an unknown in the system. Physically, the convection along the surface can be forced or free. Forced convection means that the mass flow rate of the adjacent fluid (gas or liquid) is known and its temperature is the result of heat exchange between body and fluid. This case can be simulated by CalculiX by defining network elements and using the *BOUNDARY card for the first degree of freedom in the midside node of the element. Free convection, for which the mass flow rate is a n unknown too and a result of temperature differences, cannot be simulated.

6.11.11 Radiative heat flux

Radiative heat flux is a flux depending on the temperature of the body and is triggered by the *RADIATE card. No external medium is needed. If other bodies are present, an interaction takes place. This is called cavity radiation. Usually, it is not possible to model all bodies in the environment. Then, a homogeneous environmental body temperature can be defined. In that case, the radiative flux takes the form

$$q = \epsilon\sigma(\theta^4 - \theta_0^4) \quad (849)$$

where q is a flux normal to the surface, ϵ is the emissivity, $\sigma = 5.67 \times 10^{-8} \text{ W/m}^2\text{K}^4$ is the Stefan-Boltzmann constant, θ is the absolute body temperature (Kelvin) and θ_0 is the absolute environment temperature (also called sink temperature). The emissivity takes values between 0 and 1. A zero value applied to a body with no absorption nor emission and 100 % reflection. A value of 1 applies to a black body. The radiation is assumed to be diffuse (independent of the direction of emission) and gray (independent of the emitted wave length).

If other bodies are present, the radiative interaction is taken into account and viewfactors are calculated if the user selects the appropriate load label.

6.12 Error estimators

6.12.1 Zienkiewicz-Zhu error estimator

The Zienkiewicz-Zhu error estimator [111], [112] tries to estimate the error made by the finite element discretization. To do so, it calculates for each node an improved stress and defines the error as the difference between this stress and the one calculated by the standard finite element procedure.

The stress obtained in the nodes using the standard finite element procedure is an extrapolation of the stresses at the integration points [23]. Indeed, the basic unknowns in mechanical calculations are the displacements. Differentiating the displacements yields the strains, which can be converted into stresses by means of the appropriate material law. Due to the numerical integration used to obtain the stiffness coefficients, the strains and stresses are most accurate

at the integration points. The standard finite element procedure extrapolates these integration point values to the nodes. The way this extrapolation is done depends on the kind of element [23]. Usually, a node belongs to more than one element. The standard procedure averages the stress values obtained from each element to which the node belongs.

To determine a more accurate stress value at the nodes, the Zienkiewicz-Zhu procedure starts from the stresses at the reduced integration points. This applies to quadratic elements only, since only for these elements a reduced integration procedure exists (for element types different from C3D20R the ordinary integration points are taken instead). The reduced integration points are superconvergent points, i.e. points at which the stress is an order of magnitude more accurate than in any other point within the element [7]. To improve the stress at a node an element patch is defined, usually consisting of all elements to which the nodes belongs. However, at boundaries and for tetrahedral elements this patch can contain other elements too. Now, a polynomial function is defined consisting of the monomials used for the shape function of the elements at stake. Again, to improve the accuracy, other monomials may be considered as well. The coefficients of the polynomial are defined such that the polynomial matches the stress as well as possible in the reduced integration points of the patch (in a least squares sense). Finally, an improved stress in the node is obtained by evaluating this polynomial. This is done for all stress components separately. For more details on the implementation in CalculiX the user is referred to [60].

In CalculiX one can obtain the improved CalculiX-Zhu stress by selecting ZZS underneath the *EL FILE keyword card. It is available for tetrahedral and hexahedral elements. In a node belonging to tetrahedral, hexahedral and any other type of elements, only the hexahedral elements are used to defined the improved stress, if the node does not belong to hexahedral elements the tetrahedral elements are used, if any.

6.12.2 Gradient error estimator

A different error estimator is based on the difference between the maximum and minimum of an elementwise-selected principal stress at the integration points in the elements belonging to one and the same node. It is triggered by selecting ERR underneath the *EL FILE keyword card.

The elementwise-selected principal stress is either the smallest or the largest principal stress (first or third). It is the largest principal stress if the maximum over all integration points in the element of the absolute value of the largest principal stress is larger than the maximum over all integration points in the element of the absolute value of the smallest principal stress. Else, it is the smallest principal stress.

A node usually belongs to several elements. The stresses are available (and most accurate) at the integration points of these elements. If the largest difference between the elementwise-selected principal stress at all integration points within an element is small, the stresses vary little across the element and the

element size is deemed adequate to yield an accurate stress prediction. From the absolute value of the largest difference a relative element value is calculated. The relative element value is the absolute value divided by the absolute value of the largest elementwise-selected principal stress within the element.

To obtain the relative value at the nodes the maximum is taken of the relative element value across all elements belonging to the node. In a strict sense this is not an error estimator, it is just a measure for the variation of the elementwise-selected principal stress across all elements belonging to the node.

By applying this concept to a large number of examples for which the stress error was known a heuristic relationship was deduced. It allows for a given element type to determine the error in the elementwise-selected principal stress in a node (called STR in the frd file; it is obtained by selecting ERR underneath the *EL FILE or *ELEMENT OUTPUT card) from the relative measure just defined (describing the relative change of the elementwise-selected principal stress in the adjacent elements). If a node belongs to several element types the worst value is taken. The STR-value is in %.

For heat transfer a similar error estimator was coded for the heat flux. It is triggered by selecting HER underneath the *EL FILE keyword card. It represents the variation of the size of the heat flux vector across all elements belonging to one and the same node. For thermal problems too heuristic relationships connecting the largest temperature gradient in the adjacent element to a node and the temperature error in the node have been established. The temperature error is called TEM in the frd file and is in %. It is obtained by selecting HER underneath the *EL FILE or *ELEMENT OUTPUT card.

6.13 Output variables

Output is provided with the commands *NODE FILE and *EL FILE in the .frd file (ASCII), with the commands *NODE OUTPUT and *ELEMENT OUTPUT in the .frd file (binary) and with the commands *NODE PRINT and *EL PRINT in the .dat file (ASCII). Binary .frd files are much shorter and can be faster read by CalculiX GraphiX. Nodal variables (selected by the *NODE FILE, *NODE OUTPUT and *NODE PRINT keywords) are always stored at the nodes. Element variables (selected by the *EL FILE, *ELEMENT OUTPUT and *ELEMENT PRINT keywords) are stored at the integration points in the .dat file and at the nodes in the .frd file. Notice that element variables are more accurate at the integration points. The values at the nodes are extrapolated values and consequently less accurate. For example, the von Mises stress and the equivalent plastic strain at the integration points have to lie on the stress-strain curve defined by the user underneath the *PLASTIC card, the extrapolated values at the nodes do not have to.

In fluid networks interpolation is used to calculate the nodal values at nodes in which they are not defined. Indeed, due to the structure of a network element the total temperature, the static temperature and the total pressure are determined at the end nodes, whereas the mass flow is calculated at the middle nodes. Therefore, to guarantee a continuous representation in the .frd file the

values of the total temperature, the static temperature and the total pressure at the middle nodes are interpolated from their end node values and the end node values of the mass flow are determined from the neighboring mid-node values. This is not done for .dat file values (missing values are in that case zero).

A major different between the FILE and PRINT requests is that the PRINT requests HAVE TO be accompanied by a set name. Consequently, the output can be limited to a few nodes or elements. The output in the .frd file can but does not have to be restricted to subsets. If no node set is selected by using the NSET parameter (both for nodal and element values, since output in the .frd file is always at the nodes) output is for the complete model.

The following output variables are available:

Table 18: List of output variables.

variable	meaning	type	.frd fi
CDIS	relative contact displacements	nodal	CONTA
PEEQ	equivalent plastic strain	int.point	CONTA
CELS	contact energy	nodal	PE
CF	total contact force	surface	CEL
CFN	total normal contact force	surface	
CFS	total shear contact force	surface	
CNUM	total number of contact elements	model	
COORD	coordinates	int.point	
CP	pressure coefficient in a compressible 3D fluid	nodal	CP3D
CSTR	contact stress	nodal	CONTA
DEPF	fluid depth in 3D shallow water calculations	nodal	CONTA
DEPT	fluid depth (in direction of the gravity vector) in a channel network	nodal	DISP
DTF	fluid time increment in 3D fluids	nodal	DEPT
DRAG	stress on surface	surface	DTIM
E	Lagrange strain	int.point	TOSTR
EBHE	heating power due to induction	elem	TOSTR
ECD	electric current density	int.point	CUR
ELKE	kinetic energy	element	
ELSE	internal energy	element	
EMAS	mass and mass moments of inertia	element	
EMFB	magnetic field	int.point	EMF
EMFE	electric field	int.point	EMF
ENER	internal energy density	int.point	ENE
ERR	error estimator for the worst principal stress	int.point	ERRC
EVOL	volume	element	ERRO
FLUX	flux through surface	surface	

Table 18: (continued)

variable	meaning	type	.frd file	.dat f
HCRI HER	critical depth in a channel network error estimator for the temperature	nodal int.point	HCRIT HERROR HERRORI	
HFL HFLF	heat flux in a structure heat flux in a 3D fluid	int.point int.point	FLUX FLUX	x x
KEQ	stress intensity factor	nodal	CT3D-MIS	
MACH MAXE	Mach number in a compressible 3D fluid worst principal strain in cyclic symmetric frequency calculations	nodal int.point	M3DF MSTRAIN	x
MAXS	worst principal stress in cyclic symmetric frequency calculations	int.point	MSTRESS	
MAXU	worst displacement orthogonal to a given vector in cyclic symmetric frequency calculations	nodal	MDISP	
ME	mechanical strain	int.point	MESTRAIN MESTRAII	x x
MF	mass flow in a network	nodal	MAFLOW	x
NT	structural temperature total temperature in a network	nodal	NDTEMP	x
PCON	amplitude and phase of the relative contact displacements and contact stresses	nodal	PCONTAC	
PEEQ PHS	equivalent plastic strain magnitude and phase of stress	int.point int.point	PE PSTRESS	x
PN	network pressure (generic term for any of the above)	nodal		x
PNT	magnitude and phase of temperature	nodal	PNDTEMP	
POT	electric potential	nodal	ELPOT	
PRF	magnitude and phase of external forces	nodal	PFORC	
PS	static pressure in a liquid network	nodal	STPRES	x
PSF	static pressure in a 3D fluid	nodal	PS3DF	x
PT	total pressure in a gas network	nodal	TOPRES	
PTF	total pressure in a 3D fluid	nodal	PT3DF	x
PU	magnitude and phase of displacement	nodal	PDISP	
RF	total force	nodal	FORC FORCI	x x
RFL	total flux	nodal	RFL	x

Table 18: (continued)

variable	meaning	type	.frd fi
S	Cauchy stress (structure)	int.point	STRE STRES
SDV	internal variables	int.point	SDV
SEN	sensitivity	nodal	SEN
SF	total stress (3D fluid)	int.point	STRE
SMID	Cauchy stress (shells)	int.point	STRM
SNEG	Cauchy stress (shells)	int.point	STRN
SOAREA	section area	surface	
SOF	section forces	surface	
SOM	section moments	surface	
SPOS	Cauchy stress (shells)	int.point	STRP
SVF	viscous stress (3D fluid)	int.point	VSTR
THE	thermal strain	nodal	THSTR
TS	static temperature in a network	nodal	STTEM
TSF	static temperature in a 3D fluid	nodal	TS3D
TT	total temperature in a gas network	nodal	TOTE
TTF	total temperature in a 3D fluid	nodal	TT3D
TURB	turbulence variables in a 3D fluid	nodal	TURB3
U	displacement	nodal	DISP DISP
V	velocity of a structure	nodal	VEL
VF	velocity in a 3D fluid	nodal	V3D
ZZS	Zienkiewicz-Zhu stress	int.point	ZZST ZZST

7 Input deck format

This section describes the input of CalculiX.

The jobname is defined by the argument after the `-i` flag on the command line. When starting CalculiX, it will look for an input file with the name `jobname.inp`. Thus, if you called the executable “CalculiX” and the input deck is “beam.inp” then the program call looks like

```
CalculiX -i beam
```

The `-i` flag can be dropped provided the jobname follows immediately after the CalculiX call.

CalculiX will generate an output file with the name `jobname.dat` and an output file with the name `jobname.frd`. The latter can be viewed with `cgx`.

If the step is a `*FREQUENCY` step or a `*HEAT TRANSFER,FREQUENCY` step and the parameter `STORAGE=YES` is activated, CalculiX will generate a

binary file containing the eigenfrequencies, the eigenmodes, the stiffness and the mass matrix with the name jobname.eig. If the step is a *MODAL DYNAMIC or *STEADY STATE DYNAMICS step, CalculiX will look for a file with that name. If any of the files it needs does not exist, an error message is generated and CalculiX will stop.

The input deck basically consists of a set of keywords, followed by data required by the keyword on lines underneath the keyword. The keywords can be accompanied by parameters on the same line, separated by a comma. If the parameters require a value, an equality sign must connect parameter and value. Blanks in the input have no significance and can be inserted as you like. The keywords and any other alphanumeric information can be written in upper case, lower case, or any mixture. The input deck is case insensitive: internally, all alphanumeric characters are changed into upper case. The data do not follow a fixed format and are to be separated by a comma. A line can only contain as many data as dictated by the keyword definition. The maximum length for user-defined names, e.g. for materials or sets, is 80 characters, unless specified otherwise. The structure of an input deck consists of geometric, topological and material data before the first step definition, and loading data (mechanical, thermal, or prescribed displacements) in one or more subsequent steps. The user must make sure that all data are given in consistent units (the units do not appear in the calculation).

A keyword can be of type step or model definition. Model Definition cards must be used before the first *STEP card. Step keywords can only be used within a step. Among the model definition keywords, the material ones occupy a special place: they define the properties of a material and should be grouped together following a *MATERIAL card.

Node and element sets can share the same name. Internally, the names are switched to upper case and a 'N' is appended after the name of a node set and a 'E' after the name of an element set. Therefore, set names printed in error or warning messages will be discovered to be written in upper case and to have a 'N' or 'E' appended.

Keyword cards in alphabetical order:

7.1 *AMPLITUDE

Keyword type: step or model definition

This option may be used to specify an amplitude history versus time. The amplitude history should be given in pairs, each pair consisting of a value of the reference time and the corresponding value of the amplitude or by user subroutine uamplitude.f.

There are four optional parameters TIME, USER, SHIFTX and SHIFTY and one required parameter NAME. If the parameter TIME=TOTAL TIME is used the reference time is the total time since the start of the calculation, else it is the local step time. Use as many pairs as needed, maximum four per line.

The parameter USER indicates that the amplitude history versus time was implemented in user subroutine uamplitude.f. No pair data is required.

With the parameters SHIFTX and SHIFTY the reference time and the amplitude of the (time,amplitude) pairs can be shifted by a fixed amount.

The parameter NAME, specifying a name for the amplitude so that it can be used in loading definitions (*BOUNDARY, *CLOAD, *DLOAD and *TEMPERATURE) is required (maximum 80 characters).

In each step, the local step time starts at zero. Its upper limit is given by the time period of the step. This time period is specified on the *STATIC, *DYNAMIC or *MODAL DYNAMIC keyword card. The default step time period is 1.

In *STEADY STATE DYNAMICS steps the time is replaced by frequency, i.e. the *AMPLITUDE is interpreted as amplitude versus frequency (in cycles/time).

The total time is the time accumulated until the beginning of the actual step augmented by the local step time. In *STEADY STATE DYNAMICS procedures total time coincides with frequency (in cycles/time).

The loading values specified in the loading definitions (*BOUNDARY, *CLOAD, *DLOAD and *TEMPERATURE) are reference values. If an amplitude is selected in a loading definition, the actual load value is obtained by multiplying the reference value with the amplitude for the actual (local step or total) time. If no amplitude is specified, the actual load value depends on the procedure: for a *STATIC procedure, ramp loading is assumed connecting the load value at the end of the previous step (0 if there was none) to the reference value at the end of the present step in a linear way. For *DYNAMIC and *MODAL DYNAMIC procedures, step loading is assumed, i.e. the actual load equals the reference load for all time instances within the step. Reference loads which are not changed in a new step remain active, their amplitude description, however, becomes void, unless the TIME=TOTAL TIME parameter is activated. Beware that at the end of a step, all reference values for which an amplitude was specified are replaced by their actual values at that time.

Notice that no different amplitude definitions are allowed on different degrees of freedom in one and the same node if a non-global coordinate system applied to that node. For instance, if you define a cylindrical coordinate system for a node, the amplitude for a force in radial direction has to be the same as for the tangential and axial direction.

First line:

- *AMPLITUDE
- Enter the required parameter.

Following line, using as many entries as needed (unless the parameter USER was selected):

- Time.
- Amplitude.

- Time.
- Amplitude.
- Time.
- Amplitude.
- Time.
- Amplitude.

Repeat this line if more than eight entries (four data points) are needed.

Example:

```
*AMPLITUDE,NAME=A1
0.,0.,10.,1.
```

defines an amplitude function with name A1 taking the value 0. at t=0. and the value 1. at t=10. The time used is the local step time.

Example files: beamdy1, beamnldy.

7.2 *BASE MOTION

Keyword type: step

This option is used to prescribe nonzero displacements and/or accelerations in *MODAL DYNAMIC and *STEADY STATE DYNAMICS calculations. The parameters DOF and AMPLITUDE are required, the parameter TYPE is optional.

The prescribed boundary condition applies to the degree of freedom DOF in all nodes in which a homogeneous *BOUNDARY condition has been defined for this degree of freedom. If using *BASE MOTION it is good practice to define these *BOUNDARY conditions BEFORE the step in which *BASE MOTION is used, else the effect may be unpredictable. The parameter DOF can only take the values in the range from 1 to 3. With the parameter AMPLITUDE the user specifies the amplitude defining the value of the boundary condition. This amplitude must have been defined using the *AMPLITUDE card.

The TYPE parameter can take the string DISPLACEMENT or ACCELERATION. Default is ACCELERATION. Acceleration boundary conditions can only be used for harmonic steady state dynamics calculations, displacements can be used for any modal dynamic or steady state dynamic calculation. Since only three degrees of freedom are at the user's disposal, defining more than three *base motion cards does not make sense.

The *BASE MOTION card is more restrictive than the *BOUNDARY card in the sense that the same amplitude applies to a specific degree of freedom in all nodes in which a homogeneous boundary condition for exactly this degree of

freedom has been defined. It is, however, less restrictive in the sense that for steady state dynamics calculations also accelerations can be applied.

First line and only line:

- *BASE MOTION
- Enter any needed parameters and their value.

Example:

```
*BASE MOTION,DOF=2,AMPLITUDE=A1
```

specifies a base motion with amplitude A1 for the second degree of freedom for all nodes in which a homogeneous boundary condition was defined for precisely this degree of freedom.

Example files: beamdy10bm.

7.3 *BEAM SECTION

Keyword type: model definition

This option is used to assign material properties to beam element sets. The parameters ELSET, MATERIAL and SECTION are required, the parameters ORIENTATION, OFFSET1, OFFSET2 and NODAL THICKNESS are optional. The parameter ELSET defines the shell element set to which the material specified by the parameter MATERIAL applies. The parameter ORIENTATION allows to assign local axes to the element set. If activated, the material properties are applied to the local axis. This is only relevant for non isotropic material behavior.

The parameter SECTION defines the cross section of the beam and takes the value RECT for a rectangular cross section, CIRC for an elliptical cross section, PIPE for a pipe cross section, BOX for a box cross section and GENERAL for a section defined by its area and moments of inertia. A rectangular cross section is defined by its thickness in two perpendicular directions, an elliptical cross section is defined by the length of its principal axes. These directions are defined by specifying direction 1 on the third line of the present keyword card. A pipe cross section is defined by its outer radius (first parameter) and its thickness (second parameter). A box cross section is defined by the parameters a, b, t_1, t_2, t_3 and t_4 (cf. Figure 81, a is in the local 1-direction, b is in the local 2-direction (perpendicular to the local 1-direction), t_1 is the thickness in the positive local 1-direction and so on).

Notice that, internally, PIPE and BOX cross sections are expanded into beams with a rectangular cross section (this is also the way in which the beam is stored in the .frd-file and is visualized in the postprocessor. The actual cross section is taken into account by appropriate placement of the integration points). This rectangular cross section is the smallest section completely covering the

PIPE or BOX section. For instance, for a pipe section the expanded section is square with side length equal to the outer diameter. For the expansion the local direction 1 and 2 are used, therefore, special care should be taken to define direction 1 on the second line underneath the *BEAM SECTION card. The default for direction 1 is (0,0,-1).

The GENERAL section can only be used for user element type U1 and is defined by the cross section A , the moments of inertia I_{11} , I_{12} and I_{22} and the Timoshenko shear coefficient k . The PIPE, BOX and GENERAL cross section are described in detail in Section 6.3.

The OFFSET1 and OFFSET2 parameters indicate where the axis of the beam is in relation to the reference line defined by the line representation given by the user. The index 1 and 2 refer to the local axes of the beam which are perpendicular to the local tangent. To use the offset parameters direction the local directions must be defined. This is done by defining local direction 1 on the third line of the present keyword card. The unit of the offset is the thickness of the beam in the direction of the offset. Thus, OFFSET1=0 means that in 1-direction the reference line is the axis of the shell, OFFSET2=0.5 means that in 2-direction the reference line is the top surface of the beam. The offset can take any real value and allows to construct beam of nearly arbitrary cross section and the definition of composite beams.

The parameter NODAL THICKNESS indicates that the thickness for ALL nodes in the element set are defined with an extra *NODAL THICKNESS card and that any thicknesses defined on the *BEAM SECTION card are irrelevant.

First line:

- *BEAM SECTION
- Enter any needed parameters.

Second line:

- thickness in 1-direction
- thickness in 2-direction

Third line:

- global x-coordinate of a unit vector in 1-direction (default:0)
- global y-coordinate of a unit vector in 1-direction (default:0)
- global z-coordinate of a unit vector in 1-direction (default:-1)

Example:

```
*BEAM SECTION,MATERIAL=EL,ELSET=Ea11,OFFSET1=-0.5,SECTION=RECT
3.,1.
1.,0.,0.
```

assigns material EL to all elements in (element) set Eall. The reference line is in 1-direction on the back surface, in 2-direction on the central surface. The thickness in 1-direction is 3 unit lengths, in 2-direction 1 unit length. The 1-direction is the global x-axis.

Example files: beamcom, beammix, shellbeam, swing, simplebeampipe1,simplebeampipe2,simplebeam

7.4 *BOUNDARY

Keyword type: step or model definition

This option is used to prescribe boundary conditions. This includes:

- temperature, displacements and rotations for structures
- total temperature, mass flow and total pressure for gas networks
- temperature, mass flow and static pressure for liquid networks
- temperature, mass flow and fluid depth for channels

For liquids and structures the total and static temperature virtually coincide, therefore both are represented by the term temperature.

The following degrees of freedom are being used:

- for structures:
 - 1: translation in the local x-direction
 - 2: translation in the local y-direction
 - 3: translation in the local z-direction
 - 4: rotation about the local x-axis (only for nodes belonging to beams or shells)
 - 5: rotation about the local y-axis (only for nodes belonging to beams or shells)
 - 6: rotation about the local z-axis (only for nodes belonging to beams or shells)
 - 11: temperature
- for gas networks:
 - 1: mass flow
 - 2: total pressure
 - 11: total temperature
- for liquid networks:
 - 1: mass flow
 - 2: static pressure

- 11: temperature
- for liquid channels:
 - 1: mass flow
 - 2: fluid depth
 - 11: temperature

If no *TRANSFORM card applied to the node at stake, the local directions coincide with the global ones. Notice that a *TRANSFORM card is not allowed for nodes in which boundary conditions are applied to rotations.

Optional parameters are OP, AMPLITUDE, TIME DELAY, LOAD CASE, USER, MASS FLOW, FIXED, SUBMODEL, STEP and DATA SET. OP can take the value NEW or MOD. OP=MOD is default and implies that previously prescribed displacements remain active in subsequent steps. Specifying a displacement in the same node and direction for which a displacement was defined in a previous step replaces this value. OP=NEW implies that previously prescribed displacements are removed. If multiple *BOUNDARY cards are present in a step this parameter takes effect for the first *BOUNDARY card only.

The AMPLITUDE parameter allows for the specification of an amplitude by which the boundary values are scaled (mainly used for nonlinear static and dynamic calculations). This only makes sense for nonzero boundary values. Thus, in that case the values entered on the *BOUNDARY card are interpreted as reference values to be multiplied with the (time dependent) amplitude value to obtain the actual value. At the end of the step the reference value is replaced by the actual value at that time. In subsequent steps this value is kept constant unless it is explicitly redefined or the amplitude is defined using TIME=TOTAL TIME in which case the amplitude keeps its validity.

The TIME DELAY parameter modifies the AMPLITUDE parameter. As such, TIME DELAY must be preceded by an AMPLITUDE name. TIME DELAY is a time shift by which the AMPLITUDE definition it refers to is moved in positive time direction. For instance, a TIME DELAY of 10 means that for time t the amplitude is taken which applies to time $t-10$. The TIME DELAY parameter must only appear once on one and the same keyword card.

The LOAD CASE parameter is only active in *STEADY STATE DYNAMICS calculations. LOAD CASE = 1 means that the loading is real or in-phase. LOAD CASE = 2 indicates that the load is imaginary or equivalently phase-shifted by 90° . Default is LOAD CASE = 1.

If the USER parameter is selected the boundary values are determined by calling the user subroutine uboun.f, which must be provided by the user. This applies to all nodes listed beneath the *BOUNDARY keyword. Any boundary values specified behind the degrees of freedom are not taken into account. If the USER parameter is selected, the AMPLITUDE parameter has no effect and should not be used.

The MASS FLOW parameter specifies that the *BOUNDARY keyword is used to define mass flow rates in convective problems. A mass flow rate can

only be applied to the first degree of freedom of the midside node of network elements.

Next, the `FIXED` parameter freezes the deformation from the previous step, or, if there is no previous step, sets it to zero.

Finally, the `SUBMODEL` parameter specifies that the displacements in the nodes listed underneath will be obtained by interpolation from a global model. To this end these nodes have to be part of a `*SUBMODEL,TYPE=NODE` card. On the latter card the result file (frd file) of the global model is defined. The use of the `SUBMODEL` parameter requires the `STEP` or the `DATA SET` parameter.

In case the global calculation was a `*STATIC` calculation the `STEP` parameter specifies the step in the global model which will be used for the interpolation. If results for more than one increment within the step are stored, the last increment is taken.

In case the global calculation was a `*FREQUENCY` calculation the `DATA SET` parameter specifies the mode in the global model which will be used for the interpolation. It is the number preceding the string `MODAL` in the .frd-file and it corresponds to the dataset number if viewing the .frd-file with CalculiX GraphiX. Notice that the global frequency calculation is not allowed to contain preloading nor cyclic symmetry.

Notice that the displacements interpolated from the global model are not transformed, no matter what coordinate system is applied to the nodes in the submodel. Consequently, if the displacements of the global model are stored in a local coordinate system, this local system also applies to the submodel nodes in which these displacements are interpolated. So the submodel nodes in which the displacements of the global model are interpolated, inherit the coordinate system in which the displacements of the global model were stored. The `SUBMODEL` parameter and the `AMPLITUDE` parameter are mutually exclusive.

If more than one `*BOUNDARY` card occurs in the input deck, the following rule applies: if the `*BOUNDARY` is applied to the same node AND in the same direction as in a previous application then the previous value and previous amplitude are replaced.

A distinction is made whether the conditions are homogeneous (fixed conditions), inhomogeneous (prescribed displacements) or of the submodel type.

7.4.1 Homogeneous Conditions

Homogeneous conditions should be placed before the first `*STEP` keyword card.

First line:

- `*BOUNDARY`
- Enter any needed parameters and their value.

Following line:

- Node number or node set label
- First degree of freedom constrained
- Last degree of freedom constrained. This field may be left blank if only one degree of freedom is constrained.

Repeat this line if needed.

Example:

```
*BOUNDARY
73,1,3
```

fixes the degrees of freedom one through three (global if no transformation was defined for node 73, else local) of node 73.

Example files: achteld.

7.4.2 Inhomogeneous Conditions

Inhomogeneous conditions can be defined between a *STEP card and an *END STEP card only.

First line:

- *BOUNDARY
- Enter any needed parameters and their value.

Following line:

- Node number or node set label
- First degree of freedom constrained
- Last degree of freedom constrained. This field may be left blank if only one degree of freedom is constrained.
- Actual magnitude of the prescribed displacement

Repeat this line if needed.

Example:

```
*BOUNDARY
Nall,2,2,.1
```

assigns to degree of freedom two of all nodes belonging to node set Nall the value 0.1.

Example:

```
*BOUNDARY,MASS FLOW
73,1,1,31.7
```

applies a mass flow rate of 31.7 to node 73. To have any effect, this node must be the midside node of a network element.

Example files: achteld.

7.4.3 Submodel

Submodel conditions can be defined between a *STEP card and an *END STEP card only.

First line:

- *BOUNDARY,SUBMODEL
- use the STEP or DATA SET parameter to specify the step or mode in the global model

Following line:

- Node number or node set label
- First degree of freedom to be interpolated from the global model
- Last degree of freedom to be interpolated from the global model

Repeat this line if needed.

Example:

```
*BOUNDARY,SUBMODEL
73,1,3
```

specifies that all displacements in node 73 should be obtained by interpolation from the global model.

Example files: .

7.5 *BUCKLE

Keyword type: step

This procedure is used to determine the buckling load of a structure. The load active in the last non-perturbative *STATIC step, if any, will be taken as preload if the perturbation parameter is specified on the *STEP card. All loads previous to a perturbation step are removed at the start of the step; only the

load specified within the buckling step is scaled till buckling occurs. Right now, only the stress stiffness due to the buckling load is taken into account and not the large deformation stiffness it may cause.

Buckling leads to an eigenvalue problem whose lowest eigenvalue is the scalar the load in the buckling step has to be multiplied with to get the buckling load. Thus, generally only the lowest eigenvalue is needed. This value is also called the buckling factor and it is always stored in the .dat file.

SOLVER is the only parameter. It specifies which solver is used to determine the stress stiffness due to the buckling load and to perform a decomposition of the linear equation system. This decomposition is done only once. It is repeatedly used in the iterative procedure determining the eigenvalues (the buckling factor). The following solvers can be selected:

- the SGI solver
- PaStiX
- PARDISO
- SPOOLES [3, 4].
- TAUCS
- MATRIXSTORAGE. This is not really a solver. Rather, it is an option allowing the user to store the stiffness matrix of the base loading and stress stiffness matrix of the buckling load.

Default is the first solver which has been installed of the following list: SGI, PaStiX, PARDISO, SPOOLES and TAUCS. If none is installed, no eigenvalue analysis can be performed.

The SGI solver should by now be considered as outdated. SPOOLES is very fast, but has no out-of-core capability: the size of systems you can solve is limited by your RAM memory. With 32GB of RAM you can solve up to 1,000,000 equations. TAUCS is also good, but my experience is limited to the LL^T decomposition, which only applies to positive definite systems. It has an out-of-core capability and also offers a LU decomposition, however, I was not able to run either of them so far. PARDISO is the Intel proprietary solver and is about a factor of two faster than SPOOLES. The most recent solver we tried is the freeware solver PaStiX from INRIA. It is really fast and can use the GPU. For large problems and a high end Nvidia graphical card (32 GB of RAM) we got an acceleration of a factor between 3 and 8 compared to PARDISO. We modified PaStiX for this, therefore you have to download PaStiX from our website and compile it for your system. This can be slightly tricky, however, it is worth it!

If the MATRIXSTORAGE option is used, the stiffness matrix of the base loading and the stress stiffness matrix of the buckling load are stored in files jobname.sti and jobname.str, respectively. These are ASCII files containing the nonzero entries (occasionally, they can be zero; however, none of the entries which are not listed are nonzero). Each line consists of two integers and one

real: the row number, the column number and the corresponding value. The entries are listed column per column. In addition, a file `jobname.dof` is created. It has as many entries as there are rows and columns in the stiffness and mass matrix. Each line contains a real number of the form “a.b”. Part a is the node number and b is the global degree of freedom corresponding to selected row. Notice that the program stops after creating these files. No further steps are treated. Consequently, `*BUCKLE, SOLVER=MATRIXSTORAGE` only makes sense as the last step in a calculation. Notice that for the stress stiffness matrix of the buckling load the stresses due to this load must have been determined by performing a regular static calculation. This is done automatically in CalculiX. In case the user has specified `SOLVER=MATRIXSTORAGE` the default solver is used to solve this static calculation. If the user specifies another solver (e.g. PARDISO), this solver is used for both the static calculation and the iterative procedure for the eigenvalue problem leading to the buckling load.

First line:

- `*BUCKLE`

Second line:

- Number of buckling factors desired (usually 1).
- Accuracy desired (default: 0.01).
- # Lanczos vectors calculated in each iteration (default: $4 * \text{\#eigenvalues}$).
- Maximum # of iterations (default: 1000).

It is rarely needed to change the defaults.

The eigenvalues are automatically stored in file `jobname.dat`.

Example:

```
*BUCKLE
2
```

calculates the lowest two buckling modes and the corresponding buckling factors. For the accuracy, the number of Lanczos vectors and the number of iterations the defaults are taken.

Example files: `beam8b,beamb`.

7.6 *CFD

Keyword type: step

This procedure is used to perform a three-dimensional computational fluid dynamics (CFD) calculation.

There are six optional parameters: STEADY STATE, TIME RESET, TOTAL TIME AT START, COMPRESSIBLE, TURBULENCE MODEL and SHALLOW WATER.

The initial time increment and time step period specified underneath the *CFD card are interpreted as mechanical time increment and mechanical time step. For each mechanical time increment a CFD calculation is performed consisting of several CFD time increments. Therefore, the initial CFD time increment cannot exceed the initial mechanical time increment. CFD time increments are usually much smaller than the mechanical time increments. The CFD calculation is performed up to the end of the mechanical time increment (if the calculation is transient) or up to steady state conditions (if the CFD calculation is a steady state calculation).

The parameter STEADY STATE indicates that the calculation should be performed until steady state conditions are reached. In that case the size of the mechanical time increment has not influence on the number of CFD time increments and the only limit is the value of the parameter INCF on the *STEP card. If this parameter is absent, the calculation is assumed to be time dependent and a time accurate transient analysis is performed until the end of the mechanical time increment.

The parameter TIME RESET can be used to force the total time at the end of the present step to coincide with the total time at the end of the previous step. If there is no previous step the targeted total time is zero. If this parameter is absent the total time at the end of the present step is the total time at the end of the previous step plus the time period of the present step (2nd parameter underneath the *CFD keyword). Consequently, if the time at the end of the previous step is 10. and the present time period is 1., the total time at the end of the present step is 11. If the TIME RESET parameter is used, the total time at the beginning of the present step is 9. and at the end of the present step it will be 10. This is sometimes useful if transient coupled temperature-displacement calculations are preceded by a stationary heat transfer step to reach steady state conditions at the start of the transient coupled temperature-displacement calculations. Using the TIME RESET parameter in the stationary step (the first step in the calculation) will lead to a zero total time at the start of the subsequent instationary step.

The parameter TOTAL TIME AT START can be used to set the total time at the start of the step to a specific value.

The parameter COMPRESSIBLE specifies that the fluid is compressible. Default is incompressible.

For 3D fluid calculations the parameter TURBULENCE MODEL defines the turbulence model to be used. The user can choose among NONE (laminar calculations; this is default), K-EPSILON, K-OMEGA, BSL and SST [57].

Finally, the parameter SHALLOW WATER only applied to CFD calculations with the finite element method. It indicates that the calculation is a shallow water calculation. This corresponds to a compressible fluid calculation in which the density is replaced by the fluid depth, cf. Section 6.9.20.

First line:

- *CFD
- Enter any needed parameters and their values.
- Initial time increment. This value will be modified due to automatic incrementation, unless the parameter DIRECT was specified (default 1.).
- Time period of the step (default 1.).
- Minimum time increment allowed. Only active if DIRECT is not specified. Default is the initial time increment or 1.e-5 times the time period of the step, whichever is smaller.
- Maximum time increment allowed. Only active if DIRECT is not specified. Default is 1.e+30.
- Safety factor by which the time increment calculated based on the convective and diffusive characteristics should be divided by. This factor must exceed the default of 1.25.

Example: couette1

```
*CFD
.1,1.,,
```

defines a CFD step. The second line indicates that the initial time increment is .1 and the total step time is 1.

Example files: couette1per.

7.7 *CFLUX

Keyword type: step

This option allows concentrated heat fluxes to be applied to any node in the model which is not fixed by a single or multiple point constraint. Optional parameters are OP, AMPLITUDE, TIME DELAY, USER and ADD. OP can take the value NEW or MOD. OP=MOD is default and implies that the concentrated fluxes applied to different nodes in previous steps are kept. Specifying a flux in a node for which a flux was defined in a previous step replaces this value. A flux specified in a node for which a flux was already defined within the same step is added to this value. OP=NEW implies that all concentrated fluxes applied in previous steps are removed. If multiple *CFLUX cards are present in a step this parameter takes effect for the first *CFLUX card only.

The AMPLITUDE parameter allows for the specification of an amplitude by which the flux values are scaled (mainly used for nonlinear static and dynamic calculations). Thus, in that case the values entered on the *CFLUX card are interpreted as reference values to be multiplied with the (time dependent)

amplitude value to obtain the actual value. At the end of the step the reference value is replaced by the actual value at that time. In subsequent steps this value is kept constant unless it is explicitly redefined or the amplitude is defined using `TIME=TOTAL TIME` in which case the amplitude keeps its validity.

The `TIME DELAY` parameter modifies the `AMPLITUDE` parameter. As such, `TIME DELAY` must be preceded by an `AMPLITUDE` name. `TIME DELAY` is a time shift by which the `AMPLITUDE` definition it refers to is moved in positive time direction. For instance, a `TIME DELAY` of 10 means that for time t the amplitude is taken which applies to time $t-10$. The `TIME DELAY` parameter must only appear once on one and the same keyword card.

If the `USER` parameter is selected the concentrated flux values are determined by calling the user subroutine `cflux.f`, which must be provided by the user. This applies to all nodes listed beneath the `*CFLUX` keyword. Any flux values specified following the temperature degree of freedom are not taken into account. If the `USER` parameter is selected, the `AMPLITUDE` parameter has no effect and should not be used.

Finally, the `ADD` parameter allows the user to specify that the flux should be added to previously defined fluxes in the same node, irrespective whether these fluxes were defined in the present step or in a previous step.

The use of the `*CFLUX` card makes sense for heat transfer calculations or coupled thermo-mechanical calculations only. Heat fluxes are applied to degree of freedom 11.

If more than one `*CFLUX` card occurs within the input deck the following rules apply:

If a `*CFLUX` card is applied to the same node AND in the same direction as in a previous application, then

- if the previous application was in the same step the `*CFLUX` value is added, else it is replaced
- the new amplitude (including none) overwrites the previous amplitude

First line:

- `*CFLUX`
- Enter any needed parameters and their value.

Following line:

- Node number or node set label.
- Degree of freedom (11).
- Magnitude of the flux

Repeat this line if needed.

Example:

```
*CFLUX,OP=NEW,AMPLITUDE=A1
10,11,15.
```

removes all previous concentrated heat fluxes and applies a flux with magnitude 15. and amplitude A1 for degree of freedom 11 (this is the temperature degree of freedom) of node 10.

Example files: oneel20cf.

7.8 *CHANGE CONTACT TYPE

Keyword type: step

With this option one can change the contact type at the start of a *DYNAMIC step from “SURFACE TO SURFACE” to “NODE TO SURFACE” or “MASSLESS” (the latter only in a *DYNAMIC,EXPLICIT step). This is usually done when a dynamic calculation is performed starting from steady state obtained from a previous *STATIC step.

Indeed, in a static calculation the “SURFACE TO SURFACE” contact type or “MORTAR” contact types usually perform much better (better convergence and better results) than “NODE TO SURFACE” (“MASSLESS” is not available in a static step). In a dynamic calculation performed by integration in time the “SURFACE TO SURFACE” contact, however, is too slow and too detailed in resolution of the contact area. Here, “NODE TO SURFACE” and “MASSLESS” perform better. Therefore, the present keyword was introduced in order to change the contact formulation at the start of a dynamic step.

The option *CHANGE CONTACT TYPE can also be used if a previous static step was calculated with “NODE TO SURFACE” contact (for whatever reason) and the subsequent dynamic step is to be performed with “MASSLESS” contact.

Either the parameter TO NODE TO SURFACE or TO MASSLESS is required.

First and only line:

- *CHANGE CONTACT TYPE
- Enter TO NODE TO SURFACE or TO MASSLESS (actually, blanks in the input deck are immaterial, one might also write TONODETOSURFACE and TOMASSLESS).

Example:

```
*CHANGE CONTACT TYPE,TO MASSLESS
```

Example files: changecontacttype1, changecontacttype2.

7.9 *CHANGE FRICTION

Keyword type: step

With this option one can redefine the contact friction value within a step. There is one required parameter INTERACTION, denoting the name of the *SURFACE INTERACTION the friction of which one would like to change. This card must be followed by a *FRICTION card to become effective.

First and only line:

- *CHANGE FRICTION
- enter the required parameter INTERACTION and its parameter.

Example:

```
*CHANGE FRICTION, INTERACTION=IN1
```

indicates that the friction value of surface interaction IN1 is to be changed to the value underneath the following *FRICTION card.

Example files: friction2

7.10 *CHANGE MATERIAL

Keyword type: step

With this option one can redefine material properties within a step. There is one required parameter NAME, denoting the name of the *MATERIAL. Right now, only plastic data of an elastically isotropic material with explicitly defined isotropic or kinematic hardening data can be changed. This card must be followed by a *CHANGE PLASTIC card to have any effect.

First and only line:

- *CHANGE MATERIAL
- enter the required parameter NAME and its parameter.

Example:

```
*CHANGE MATERIAL, NAME=PL
```

indicates that the plastic data of material PL are to be changed to the values underneath the following *CHANGE PLASTIC card.

Example files: beampiso2

7.11 *CHANGE PLASTIC

Keyword type: step

With this option one can redefine plastic data of an elastically isotropic material with explicitly defined isotropic or kinematic hardening data within a step. Combined hardening or user-defined hardening data are not allowed.

There is one optional parameter HARDENING. Default is HARDENING=ISOTROPIC, the only other value is HARDENING=KINEMATIC for kinematic hardening. All constants may be temperature dependent.

For the selection of plastic output variables the reader is referred to Section 6.8.8.

First line:

- *CHANGE PLASTIC
- Enter the HARDENING parameter and its value, if needed

Following sets of lines define the isotropic hardening curve for HARDENING=ISOTROPIC and the kinematic hardening curve for HARDENING=KINEMATIC:

First line in the first set:

- Von Mises stress.
- Equivalent plastic strain.
- Temperature.

Use as many lines in the first set as needed to define the complete hardening curve for this temperature.

Use as many sets as needed to define complete temperature dependence. Notice that it is not allowed to use more plastic strain data points or temperature data points than the amount used for the first definition of the plastic behavior for this material (in the *PLASTIC card).

The raison d'être for this card is its ability to switch from purely plastic behavior to creep behavior and vice-versa. The viscoplastic for isotropic materials in CalculiX is an overstress model, i.e. creep only occurs above the yield stress. For a lot of materials this is not realistic. It is observed in blades and vanes that at high temperatures creep occurs at stresses well below the yield stress. By using the *CHANGE PLASTIC card the yield stress can be lowered to zero in a creep (*VISCO) step following an inviscid (*STATIC) plastic deformation step.

Example:

```
*CHANGE PLASTIC
0.,0.
0.,1.e10
```

defines a material with yield stress zero.

Example files: beampiso2

7.12 *CHANGE SOLID SECTION

Keyword type: step

This option is used to change material properties within a step for 3D, plane stress, plane strain or axisymmetric element sets. The parameters ELSET and MATERIAL are required, the parameter ORIENTATION is optional. The parameter ELSET defines the element set to which the material specified by the parameter MATERIAL applies. The parameter ORIENTATION allows to assign local axes to the element set. If activated, the material properties are applied to the local axis. This is only relevant for non isotropic material behavior.

It is not allowed to change the thickness, which is important for plane stress and plane strain elements. This is because these elements are expanded in three dimensional elements within the first step. So no second line is allowed.

Changing material properties may be used to activate or deactivate elements by assigning properties close to those of air to one material and the real properties to another material and switching between these.

First line:

- *CHANGE SOLID SECTION
- Enter any needed parameters.

Example:

```
*CHANGE SOLID SECTION,MATERIAL=EL,ELSET=Ea11,ORIENTATION=OR1
```

reassigns material EL with orientation OR1 to all elements in (element) set Ea11.

Example files: changesolidsection.

7.13 *CHANGE SURFACE BEHAVIOR

Keyword type: step

With this option one can redefine the contact surface behavior within a step. There is one required parameter INTERACTION, denoting the name of the *SURFACE INTERACTION the surface behavior of which one would like to change. This card must be followed by a *SURFACE BEHAVIOR card to become effective.

First and only line:

- *CHANGE SURFACE BEHAVIOR
- enter the required parameter INTERACTION and its parameter.

Example:

```
*CHANGE SURFACE BEHAVIOR,INTERACTION=IN1
```

indicates that the surface behavior value of surface interaction IN1 is to be changed to the value underneath the following *SURFACE BEHAVIOR card.

Example files: changesurfbeh

7.14 *CLEARANCE

Keyword type: model definition

With this option a clearance can be defined between the slave and master surface of a contact pair. It only applies to face-to-face contact (penalty or mortar). If this option is active, the actual clearance or overlapping based on the distance between the integration point on the slave surface and its orthogonal projection on the master surface is overwritten by the value specified here. There are three required parameters: MASTER, SLAVE and VALUE. With MASTER one specifies the master surface, with SLAVE the slave surface and with VALUE the value of the clearance. Only one value per contact pair is allowed.

First and only line:

- *CLEARANCE
- enter the required parameters and their values.

Example:

```
*CLEARANCE,MASTER=SURF1,SLAVE=SURF2,VALUE=0.1
```

indicates that the clearance between master surface SURF1 and slave surface SURF2 should be 0.1 length units. SURF1 and SURF2 must be used on one and the same *CONTACT PAIR card.

Example files:

7.15 *CLOAD

Keyword type: step

This option allows concentrated forces to be applied to any node in the model which is not fixed by a single or multiple point constraint. Optional parameters are OP, AMPLITUDE, TIME DELAY, USER, LOAD CASE, SECTOR, SUB-MODEL, STEP, DATA SET and OMEGA0. OP can take the value NEW or MOD. OP=MOD is default and implies that the concentrated loads applied to different nodes in previous steps are kept. Specifying a force in a node for which a force was defined in a previous step replaces this value. A force specified in a

node and direction for which a force was already defined within the same step is added to this value. OP=NEW implies that all concentrated loads applied in previous steps are removed. If multiple *CLOAD cards are present in a step this parameter takes effect for the first *CLOAD card only.

The AMPLITUDE parameter allows for the specification of an amplitude by which the force values are scaled (mainly used for nonlinear static and dynamic calculations). Thus, in that case the values entered on the *CLOAD card are interpreted as reference values to be multiplied with the (time dependent) amplitude value to obtain the actual value. At the end of the step the reference value is replaced by the actual value at that time. In subsequent steps this value is kept constant unless it is explicitly redefined or the amplitude is defined using TIME=TOTAL TIME in which case the amplitude keeps its validity.

The AMPLITUDE parameter applies to all loads specified by the same *CLOAD card. This means that, by using several *CLOAD cards, different amplitudes can be applied to the forces in different coordinate directions in one and the same node. An important exception to this rule are nodes in which a transformation applies (by using the *TRANSFORM card): an amplitude defined for such a node applies to ALL coordinate directions. If several are defined, the last one applies.

The TIME DELAY parameter modifies the AMPLITUDE parameter. As such, TIME DELAY must be preceded by an AMPLITUDE name. TIME DELAY is a time shift by which the AMPLITUDE definition it refers to is moved in positive time direction. For instance, a TIME DELAY of 10 means that for time t the amplitude is taken which applies to time $t-10$. The TIME DELAY parameter must only appear once on one and the same keyword card.

If the USER parameter is selected the concentrated load values are determined by calling the user subroutine cload.f, which must be provided by the user. This applies to all nodes listed beneath the *CLOAD keyword. Any load values specified following the degree of freedom are not taken into account. If the USER parameter is selected, the AMPLITUDE parameter has no effect and should not be used.

The LOAD CASE parameter is only active in *STEADY STATE DYNAMICS calculations. LOAD CASE = 1 means that the loading is real or in-phase. LOAD CASE = 2 indicates that the load is imaginary or equivalently phase-shifted by 90° . Default is LOAD CASE = 1.

The SECTOR parameter can only be used in *MODAL DYNAMIC and *STEADY STATE DYNAMICS calculations with cyclic symmetry. The datum sector (the sector which is modeled) is sector 1. The other sectors are numbered in increasing order in the rotational direction going from the slave surface to the master surface as specified by the *TIE card. Consequently, the SECTOR parameters allows to apply a point load to any node in any sector. However, the only coordinate systems allowed in a node in which a force is applied in a sector different from the datum sector are restricted to the global Cartesian system and a local cylindrical system. If the global coordinate system applies, the force defined by the user (in the global system) is simply copied to the appropriate sector without changing its direction. The user must make sure

the direction of the force is the one needed in the destination sector. If a local cylindrical system applies, this system must be identical with the one defined underneath the `*CYCLIC SYMMETRY MODEL` card. In that case, the force defined in the datum sector is rotated towards the destination sector, i.e. the radial, circumferential and axial part of the force is kept.

The `SUBMODEL` parameter specifies that the forces in the specified degrees of freedom of the nodes listed underneath will be obtained by interpolation from a global model. To this end these nodes have to be part of a `*SUBMODEL,TYPE=NODE` card. On the latter card the result file (frd file) of the global model is defined. The use of the `SUBMODEL` parameter requires the `STEP` or the `DATA SET` parameter.

In case the global calculation was a `*STATIC` calculation the `STEP` parameter specifies the step in the global model which will be used for the interpolation. If results for more than one increment within the step are stored, the last increment is taken.

In case the global calculation was a `*FREQUENCY` calculation the `DATA SET` parameter specifies the mode in the global model which will be used for the interpolation. It is the number preceding the string `MODAL` in the .frd-file and it corresponds to the dataset number if viewing the .frd-file with `CalculiX GraphiX`. Notice that the global frequency calculation is not allowed to contain preloading nor cyclic symmetry.

Notice that the forces interpolated from the global model are not transformed, no matter what coordinate system is applied to the nodes in the submodel. Consequently, if the forces of the global model are stored in a local coordinate system, this local system also applies to the submodel nodes in which these forces are interpolated. So the submodel nodes in which the forces of the global model are interpolated, inherit the coordinate system in which the forces of the global model were stored. The `SUBMODEL` parameter and the `AMPLITUDE` parameter are mutually exclusive.

Notice that the interpolation of the forces from a global model onto a submodel is only correct if the global and submodel mesh coincide. Else, force equilibrium is violated. Therefore, the option to interpolate forces on submodels only makes sense if it is preceded by a submodel calculation (the same submodel) with displacement interpolation and force output request. Summarizing, in order to create a force-driven calculation of a submodel, knowing the displacement results in the global model one would proceed as follows:

- perform a submodel calculation with displacement boundary conditions obtained by interpolation from the global model; request the output of the forces in the nodes on the boundary of the submodel in frd-format (let us call this file `submodel.frd`).
- repeat the submodel calculation but now with force boundary conditions obtained by interpolation from the previous submodel calculation (i.e. replace the global file in the submodel input deck by `submodel.frd` and the `*BOUNDARY,SUBMODEL` card by a `*CLOAD,SUBMODEL` card).

Applications of this technique include force-driven fracture mechanics calculations.

Finally, the OMEGA0 parameter (notice that the last character is the number zero, not the letter O) specifies the value of ω_0 in a *GREEN step. It is a required parameter in a *GREEN step.

If more than one *CLOAD card occurs within the input deck the following rules apply:

If a *CLOAD card is applied to the same node AND in the same direction as in a previous application, then

- if the previous application was in the same step the *CLOAD value is added, else it is replaced
- the new amplitude (including none) overwrites the previous amplitude

First line:

- *CLOAD
- Enter any needed parameters and their value.

Following line:

- Node number or node set label.
- Degree of freedom.
- Magnitude of the load

Repeat this line if needed.

Example:

```
*CLOAD,OP=NEW,AMPLITUDE=A1,TIME DELAY=20.
1000,3,10.3
```

removes all previous point load forces and applies a force with magnitude 10.3 and amplitude A1 (shifted in positive time direction by 20 time units) for degree of freedom three (global if no transformation was defined for node 1000, else local) of node 1000.

Example files: achtelp, beamdelay.

7.16 *COMPLEX FREQUENCY

Keyword type: step

This procedure card is used to determine frequencies taking into account Coriolis forces (cf. Section 6.9.3). It must be preceded by a *FREQUENCY step in which the eigenvalues and eigenmodes are calculated without Coriolis (do

not forget to use the option STORAGE=YES in the frequency step, ensuring that the eigenmodes and eigenvalues are stored in a .eig file). The frequency step does not have to be in the same input deck. There is one required parameter CORIOLIS.

Finally, the number of eigenfrequencies requested should not exceed the corresponding number in the frequency step.

First line:

- *COMPLEX FREQUENCY
- use the required parameter CORIOLIS

Second line:

- Number of eigenfrequencies desired.

Example:

```
*COMPLEX FREQUENCY, CORIOLIS
10
```

requests the calculation of the 10 lowest eigenfrequencies and corresponding eigenmodes.

Example files: rotor.

7.17 *CONDUCTIVITY

Keyword type: model definition, material

This option is used to define the conductivity coefficients of a material. There is one optional parameter TYPE. Default is TYPE=ISO, other values are TYPE=ORTHO for orthotropic materials and TYPE=ANISO for anisotropic materials. All constants may be temperature dependent. The unit of the conductivity coefficients is energy per unit of time per unit of length per unit of temperature.

First line:

- *CONDUCTIVITY
- Enter the TYPE parameter and its values, if needed

Following line for TYPE=ISO:

- κ .
- Temperature.

Repeat this line if needed to define complete temperature dependence.

Following line for TYPE=ORTHO:

- κ_{11} .
- κ_{22} .
- κ_{33} .
- Temperature.

Repeat this line if needed to define complete temperature dependence.

Following line for TYPE=ANISO:

- κ_{11} .
- κ_{22} .
- κ_{33} .
- κ_{12} .
- κ_{13} .
- κ_{23} .
- Temperature.

Repeat this line if needed to define complete temperature dependence.

Example:

```
*CONDUCTIVITY
50.,373.
100.,573.
```

tells you that the conductivity coefficient in a body made of this material is 50 at $T = 373$ and 100 at $T = 573$. Below $T = 373$ its value is set to 50, above $T = 573$ it is set to 100 and in between linear interpolation is applied.

Example files: beamhtbo, oneel20f.

7.18 *CONSTRAINT

Keyword type: step

With *CONSTRAINT one can define constraints on design responses in a feasible direction step. It can only be used for design variables of type COORDINATE. Furthermore, exactly one objective function has to be defined within the same feasible direction step (using the *OBJECTIVE keyword).

A constraint is an inequality expressing a condition on a design response function. The inequality can be of type “smaller than or equal” (LE) or “larger than or equal” (GE). The reference value for the inequality is to be specified by a relative portion of an absolute value (the latter in the units used by the user). For instance, suppose the user introduces an absolute value of 20 and

a relative value of 0.9 for a LE constraint on the mass. Then the mass is not allowed to exceed $0.9 \times 20 = 18$ mass units. If the absolute value is zero, the initial value is taken, e.g. for the mass this corresponds to the mass at the start of the calculation. If no relative value is given 1. is taken.

Right now, the following design responses are allowed:

- ALL-DISP: the square root of the sum of the square of the displacements in all nodes of the structure or of a subset if a node set is defined
- X-DISP: the square root of the sum of the square of the x-displacements in all nodes of the structure or of a subset if a node set is defined
- Y-DISP: the square root of the sum of the square of the y-displacements in all nodes of the structure or of a subset if a node set is defined
- Z-DISP: the square root of the sum of the square of the z-displacements in all nodes of the structure or of a subset if a node set is defined
- EIGENFREQUENCY: all eigenfrequencies calculated in a previous (actually, the eigenvalues, which are the square of the eigenfrequencies). *FREQUENCY step
- MASS: mass of the total structure or of a subset if an element set is defined
- STRAIN ENERGY: internal energy of the total structure or of a subset if an element set is defined
- MISESSTRESS: the maximum von Mises stress of the total structure or of a subset if a node set is defined. The maximum is approximated by the Kreisselmeier-Steinhauser function

$$f = \frac{1}{\rho} \ln \sum_i e^{\rho \frac{\sigma_i}{\bar{\sigma}}}, \quad (850)$$

where σ_i is the von Mises stress in node i, ρ and $\bar{\sigma}$ are user-defined parameters. The higher ρ the closer f is to the actual maximum (a value of 10 is recommended; the higher this value, the sharper the turns in the function). $\bar{\sigma}$ is the target stress, it should not be too far away from the actual maximum. The target stress must be positive.

- PS1STRESS: the maximum of the highest principal stress of the total structure or of a subset if a node set is defined. The maximum is approximated by the Kreisselmeier-Steinhauser function (cf. MISESSTRESS above, also here the target stress must be positive).
- PS3STRESS: the minimum of the lowest principal stress of the total structure or of a subset if a node set is defined. The minimum is approximated by the Kreisselmeier-Steinhauser function. The target stress for PS3STRESS must be negative.

- **EQUIVALENT PLASTIC STRAIN:** the maximum equivalent plastic strain of the total structure or of a subset if a node set is defined. The maximum is approximated by the Kreisselmeier-Steinhauser function. The target equivalent plastic strain must be positive.

First line:

- *CONSTRAINT.

Second line:

- the name of the design response
- LE for “smaller than or equal”, GE for “larger than or equal”
- a relative value for the constraint
- an absolute value for the constraint

Repeat this line if needed.

Example:

```
*SENSITIVITY
*DESIGN RESPONSE,NAME=DESRESP1
MASS,E1
.
.
.
*FEASIBLE DIRECTION
*CONSTRAINT
DESRESP1,LE,,3.
```

specifies that the mass of element set E1 should not exceed 3 in the user’s units.

Example files: opt1.

7.19 *CONTACT DAMPING

Keyword type: model definition

With this option a damping constant can be defined for contact elements. It is one of the optional cards one can use within a *SURFACE INTERACTION definition. Contact damping is available for implicit *DYNAMIC calculations only. For explicit *DYNAMIC calculations it has not been implemented yet.

The contact damping is applied in normal direction to the master surface of the contact pair. The resulting damping force is the product of the damping coefficient with the area times the local normal velocity difference between the

master and slave surface. With the optional parameter TANGENT FRACTION the user can define what fraction of the damping coefficient should be used in tangential direction, default is zero. For a nonzero tangential damping a tangential force results from the product of the tangential damping constant multiplied with the area times the local tangential velocity difference vector. In CalculiX, contact damping is implemented for small deformations.

First line:

- *CONTACT DAMPING
- enter the TANGENT FRACTION parameter if needed

Second line:

- Damping constant.

No temperature dependence is allowed

Example:

```
*SURFACE INTERACTION,NAME=SI1
*SURFACE BEHAVIOR,PRESSURE-OVERCLOSURE=LINEAR
1.e7
*CONTACT DAMPING
1.e-4
```

defines a contact damping with value 10^{-4} for all contact pairs using the surface interaction SI1.

Example files: contdamp1, contdamp2.

7.20 *CONTACT FILE

Keyword type: step

This option is used to print selected nodal contact variables in file jobname.frd for subsequent viewing by CalculiX GraphiX. The following variables can be selected (the label in square brackets [] is the one used in the .frd file; for frequency calculations with cyclic symmetry both a real and an imaginary part may be stored, in all other cases only the real part is stored):

- CDIS [CONTACT(real), CONTACTI(imaginary)]: Relative contact displacements (for node-to-face contact in frequency calculations with cyclic symmetry only for the base sector); entities: [COPEN],[CSLIP1],[CSLIP2].
- CSTR [CONTACT(real), CONTACTI(imaginary)]: Contact stresses (for node-to-face contact in frequency calculations with cyclic symmetry only for the base sector); entities: [CPRESS],[CSHEAR1][CSHEAR2].

- CELS [CELS]: Contact energy
- PCON [PCONTAC; entity: O=opening, SL=slip, P=pressure, SH=shear stress]: Magnitude and phase of the relative contact displacements and contact stresses in a frequency calculation with cyclic symmetry. PCON can only be requested for face-to-face penalty contact.

Since contact is modeled by nonlinear springs the contact energy corresponds to the spring energy. All variables are stored at the slave nodes.

The relative contact displacements constitute a vector with three components. The first component is the clearance (entity [COPEN]), i.e. the distance between the slave node and the master surface. Only negative values are stored; they correspond to a penetration of the slave node into the master surface. Positive values (i.e. a proper clearance) are set to zero. The second and third component (entities [CSLIP1],[CSLIP2]) represent the projection of the relative displacement between the two contact surfaces onto the master surface. To this end two local tangential unit vectors are defined on the master surface; the first is the normalized projection of a vector along the global x-axis on the master surface. If the global x-axis is nearly orthogonal to the master surface, the projection of a vector along the global z-axis is taken. The second is the vector product of a vector locally normal to the master surface with the first tangential unit vector. Now, the components of the projection of the relative displacement between the two contact surfaces onto the master surface with respect to the first and the second unit tangential vector are the second and third component of CDIS, respectively. They are only calculated if a friction coefficient has been defined underneath *FRICTION.

In the same way the contact stresses constitute a vector, the first component of which is the contact pressure (entity [CPRESS]), while the second and third component are the components of the shear stress vector exerted by the slave surface on the master surface with respect to the first and second unit tangential vector, respectively (entities [CSHEAR1], [CSHEAR2]).

The selected variables are stored for the complete model, but are only nonzero in the slave nodes of contact definitions.

The first occurrence of a *CONTACT FILE keyword card within a step wipes out all previous nodal contact variable selections for file output. If no *CONTACT FILE card is used within a step the selections of the previous step apply. If there is no previous step, no nodal contact variables will be stored.

There are four optional parameters: FREQUENCY, TIME POINTS, LAST ITERATIONS and CONTACT ELEMENTS. The parameters FREQUENCY and TIME POINTS are mutually exclusive.

FREQUENCY applies to nonlinear calculations where a step can consist of several increments. Default is FREQUENCY=1, which indicates that the results of all increments will be stored. FREQUENCY=N with N an integer indicates that the results of every Nth increment will be stored. The final results of a step are always stored. If you only want the final results, choose N very big. The value of N applies to *OUTPUT,*ELEMENT OUTPUT, *EL FILE,

*ELPRINT, *NODE OUTPUT, *NODE FILE, *NODE PRINT, *SECTION PRINT, *CONTACT OUTPUT, *CONTACT FILE and *CONTACT PRINT. If the FREQUENCY parameter is used for more than one of these keywords with conflicting values of N, the last value applies to all. A frequency parameter stays active across several steps until it is overwritten by another FREQUENCY value or the TIME POINTS parameter.

With the parameter TIME POINTS a time point sequence can be referenced, defined by a *TIME POINTS keyword. In that case, output will be provided for all time points of the sequence within the step and additionally at the end of the step. No other output will be stored and the FREQUENCY parameter is not taken into account. Within a step only one time point sequence can be active. If more than one is specified, the last one defined on any of the keyword cards *EL FILE, *ELPRINT, *NODE FILE, *NODE PRINT, *SECTION PRINT, *CONTACT FILE and *CONTACT PRINT will be active. The TIME POINTS option should not be used together with the DIRECT option on the procedure card. The TIME POINTS parameters stays active across several steps until it is replaced by another TIME POINTS value or the FREQUENCY parameter.

The parameter LAST ITERATIONS leads to the storage of the displacements in all iterations of the last increment in a file with name ResultsForLastIterations.frd (can be opened with CalculiX GraphiX). This is useful for debugging purposes in case of divergence. No such file is created if this parameter is absent.

Finally, the parameter CONTACT ELEMENTS stores the contact elements which have been generated in each iteration in a file with the name jobname.cel. When opening the frd file with CalculiX GraphiX these files can be read with the command “read jobname.cel inp” and visualized by plotting the elements in the sets $contactelements_st\alpha_in\beta_at\gamma_it\delta$, where α is the step number, β the increment number, γ the attempt number and δ the iteration number.

Notice that CDIS and CSTR results are stored together, i.e. specifying CDIS will automatically store CSTR too and vice versa.

First line:

- *CONTACT FILE
- Enter any needed parameters and their values.

Second line:

- Identifying keys for the variables to be printed, separated by commas.

Example:

```
*CONTACT FILE, TIME POINTS=T1
CDIS, CSTR
```

requests the storage of the relative contact displacements and contact stresses in the .frd file for all time points defined by the T1 time points sequence.

Example files: cubef2f2.

7.21 *CONTACT OUTPUT

Keyword type: step

This option is used to print selected nodal contact variables in file job-name.frd for subsequent viewing by CalculiX GraphiX. The options and its use are identical with the *CONTACT FILE keyword, however, the resulting .frd file is a mixture of binary and ASCII (the .frd file generated by using *CONTACT FILE is completely ASCII). This has the advantage that the file is smaller and can be faster read by cgx.

If FILE and OUTPUT cards are mixed within one and the same step the last such card will determine whether the .frd file is completely in ASCII or a mixture of binary and ASCII.

Example:

```
*CONTACT OUTPUT,TIME POINTS=T1
CDIS,CSTR
```

requests the storage of the relative contact displacements and contact stresses in the .frd file for all time points defined by the T1 time points sequence.

Example files: .

7.22 *CONTACT PAIR

Keyword type: model definition

This option is used to express that two surfaces can make contact. There are two required parameters: INTERACTION and TYPE, and two optional parameters: SMALL SLIDING and ADJUST. The dependent surface is called the slave surface, the independent surface is the master surface. Surfaces are defined using the *SURFACE keyword card. The dependent surface can be defined as a nodal surface (option TYPE=NODE on the *SURFACE keyword) or as an element face surface (default for the *SURFACE card), whereas the independent surface has to be defined as an element face surface. If you are using quadratic elements, or if you select face-to-face contact, however, the slave (= dependent) surface has to be defined based on element faces too and not on nodes.

If the master surface is made up of edges of axisymmetric elements make sure that none of the edges contains nodes on the axis of symmetry. Indeed, such edges are expanded into collapsed quadrilaterals the normals on which cannot be determined in the usual way.

The INTERACTION parameter takes the name of the surface interaction (keyword *SURFACE INTERACTION) which applies to the contact pair. The surface interaction defines the nature of the contact (hard versus soft contact..)

The TYPE parameter can take the value NODE TO SURFACE, SURFACE TO SURFACE, MORTAR, LINMORTAR, PGLINMORTAR or MASSLESS. NODE TO SURFACE triggers node-to-face penalty contact, SURFACE TO SURFACE face-to-face penalty contact. MORTAR triggers the mortar method with standard dual shape functions for the Lagrange multipliers, LINMORTAR the mortar method with linear dual shape functions and PGLINMORTAR the Petrov-Galerkin method in which the usual shape functions are used to describe the variation of the Lagrange multiplier. For details the reader is referred to Section 6.7.7 and [91]-[94]. If the reader wants to apply mortar contact, it is suggested to start with MORTAR contact and to use LINMORTAR or PGLINMORTAR only if MORTAR fails. Finally, MASSLESS triggers the massless contact explicit dynamics procedure. Notice that although several *CONTACT PAIR cards can be used within one and the same input deck, all must be of the same type. It is not allowed to mix NODE TO SURFACE, SURFACE TO SURFACE MORTAR, LINMORTAR, PGLINMORTAR and MASSLESS contact within one and the same input deck.

The SMALL SLIDING parameter only applies to node-to-face penalty contact. If it is not active, the contact is large sliding. This means that the pairing between the nodes belonging to the dependent surface and faces of the independent surface is performed anew in every iteration. If the SMALL SLIDING parameter is active, the pairing is done once at the start of every increment and kept during the complete increment. SMALL SLIDING usually converges better than LARGE SLIDING, since changes in the pairing can deteriorate the convergence rate. For face-to-face contact (SURFACE TO SURFACE, MORTAR, LINMORTAR or PGLINMORTAR) small sliding is active by default.

The ADJUST parameter allows the user to move selected slave nodes at the start of the calculation (i.e. at the start of the first step) such that they make contact with the master surface. This is a change of coordinates, i.e. the geometry of the structure at the start of the calculation is changed. This can be helpful if due to inaccuracies in the modeling a slave node which should lie on the master surface at the start of the calculation actually does not. Especially in static calculations this can lead to a failure to detect contact in the first increment and large displacements (i.e. acceleration due to a failure to establish equilibrium). These large displacements may jeopardize convergence in any subsequent iteration. The ADJUST parameter can be used with a node set as argument or with a nonnegative real number. If a node set is selected, all nodes in the set are adjusted at the start of the calculation. If a real number is specified, all nodes for which the clearance is smaller or equal to this number are adjusted. Penetration is interpreted as a negative clearance and consequently all penetrating nodes are always adjusted, no matter how small the adjustment size (which must be nonnegative). Notice that large adjustments can lead to deteriorated element quality. The adjustments are done along a vector through the slave node and locally orthogonal to the master surface.

First line:

- *CONTACT PAIR
- enter the required parameter INTERACTION and any optional parameters.

Following line:

- Name of the slave surface (can be nodal or element face based).
- Name of the master surface (must be based on element faces).

Repeat this line if needed.

Example:

```
*CONTACT PAIR,INTERACTION=IN1,ADJUST=0.01
dep,ind
```

defines a contact pair consisting of the surface dep as dependent surface and the element face surface ind as independent surface. The name of the surface interaction is IN1. All slave nodes for which the clearance is smaller than or equal to 0.01 will be moved onto the master surface.

Example files: contact1, contact2.

7.23 *CONTACT PRINT

Keyword type: step

This option is used to print selected nodal and/or integration point and/or surface variables in file jobname.dat. The following variables can be selected:

- Relative contact displacements (key=CDIS)
- Contact stresses (key=CSTR)
- Contact spring energy (key=CELS)
- Total number of contact elements (key=CNUM)
- Total force on a slave surface (key=CF)
- Total normal force on a slave surface (key=CFN)
- Total shear force on a slave surface (key=CFS)

Contact quantities CDIS, CSTR and CELS are stored for all active slave nodes in the model for node-to-face penalty contact and for all active integration points in the slave face for face-to-face penalty contact. The relative contact displacements and the stresses consist of one component normal to the master surface and two components tangential to it. Positive values of the normal components represent the normal material overlap and the pressure, respectively. For the direction of the tangential unit vectors used to calculate the relative tangential displacement and shear stresses the user is referred to *CONTACT FILE. The energy is a scalar quantity.

The contact quantity CNUM is one scalar listing the total number of contact elements in the model.

The quantities CF, CFN and CFS represent the total force, total normal force and total shear force acting on the slave surface, respectively, for a selected face-to-face penalty contact pair. In addition, moments of these forces about the global origin, the location of the center of gravity and the area of the contact area and the moment about the center of gravity are printed.

There are five parameters, FREQUENCY, TIME POINTS, TOTALS, SLAVE and MASTER. FREQUENCY and TIME POINTS are mutually exclusive.

The parameter FREQUENCY is optional, and applies to nonlinear calculations where a step can consist of several increments. Default is FREQUENCY=1, which indicates that the results of all increments will be stored. FREQUENCY=N with N an integer indicates that the results of every Nth increment will be stored. The final results of a step are always stored. If you only want the final results, choose N very big. The value of N applies to *OUTPUT, *ELEMENT OUTPUT, *EL FILE, *ELPRINT, *NODE OUTPUT, *NODE FILE, *NODE PRINT, *SECTION PRINT, *CONTACT OUTPUT, *CONTACT FILE and *CONTACT PRINT. If the FREQUENCY parameter is used for more than one of these keywords with conflicting values of N, the last value applies to all. A frequency parameter stays active across several steps until it is overwritten by another FREQUENCY value or the TIME POINTS parameter.

With the parameter TIME POINTS a time point sequence can be referenced, defined by a *TIME POINTS keyword. In that case, output will be provided for all time points of the sequence within the step and additionally at the end of the step. No other output will be stored and the FREQUENCY parameter is not taken into account. Within a step only one time point sequence can be active. If more than one is specified, the last one defined on any of the keyword cards *NODE FILE, *EL FILE, *NODE PRINT, *EL PRINT or *FACE PRINT will be active. The TIME POINTS option should not be used together with the DIRECT option on the procedure card. The TIME POINTS parameters stays active across several steps until it is replaced by another TIME POINTS value or the FREQUENCY parameter.

The first occurrence of a *CONTACT PRINT keyword card within a step wipes out all previous contact variable selections for print output. If no *CONTACT PRINT card is used within a step the selections of the previous step apply, if any.

The parameter TOTALS only applies to the energy. If TOTALS=YES the

sum of the contact spring energy for all contact definitions is printed in addition to their value for each active slave node (node-to-face contact) or active slave face integration point (face-to-face penalty contact) separately. If TOTALS=ONLY is selected the sum is printed but the individual contributions are not. If TOTALS=NO (default) the individual contributions are printed, but their sum is not.

If the model contains axisymmetric elements the spring energy applies to a segment of 2°. So for the total spring energy this value has to be multiplied by 180.

The parameters SLAVE and MASTER are used to define a contact pair. They are only needed for the output variables CF, CFN and CFS. They have to correspond to the face based master of slave surface of an existing contact pair.

First line:

- *CONTACT PRINT

Second line:

- Identifying keys for the variables to be printed, separated by commas.

Example:

```
*CONTACT PRINT
CDIS
```

requests the storage of the relative displacements in all slave nodes in the .dat file.

Example files: beampkin, beamrb, contact5.

7.24 *CONTROLS

Keyword type: step

This option is used to change the iteration control parameters. It should only be used by those users who know what they are doing and are expert in the field. A detailed description of the convergence criteria is given in Section 6.10. There are two, mutually exclusive parameter: PARAMETERS and RESET. The RESET parameter resets the control parameters to their defaults. The parameter PARAMETERS is used to change the defaults. It can take the value TIME INCREMENTATION, FIELD, LINE SEARCH, NETWORK, CFD or CONTACT. If the TIME INCREMENTATION value is selected, the number of iterations before certain actions are taken (e.g. the number of divergent iterations before the increment is reattempted) can be changed and effect of these actions (e.g. the increment size is divided by two). The FIELD parameter can be used to change the convergence criteria themselves.

LINE SEARCH can be used to change the line search parameters (only for face-to-face penalty contact). The line search parameter scales the correction to

the solution calculated by the Newton-Raphson algorithm such that the residual force is orthogonal to the correction. This requires the solution of a nonlinear equation, and consequently an iterative procedure. In CalculiX this procedure is approximated by a linear connection between:

- the scalar product of the residual force from the last iteration with the solution correction in the present iteration (corresponds to a line search parameter of zero) and
- the scalar product of the residual force in the present iteration with the solution correction in the present iteration (corresponds to a line search parameter of one).

For details of the line search algorithm the reader is referred to [109].

With the NETWORK parameter the convergence criteria for network iterations can be changed. The parameters c_{1t} , c_{1f} and c_{1p} express the fraction of the mean energy balance, mass balance and element balance the energy balance residual, the mass balance residual and the element balance residual is not allowed to exceed, respectively. The parameters c_{2t} , c_{2f} , c_{2p} and c_{2a} is the fraction of the change in temperature, mass flow, pressure and geometry since the beginning of the increment the temperature, mass flow, pressure and geometry change in the actual network iteration is not allowed to exceed, respectively. The same applies to the parameters a_{1t} , a_{1f} , a_{1p} , a_{2t} , a_{2f} , a_{2p} and a_{2a} , except that they are absolute values and not fractions, e.g. the mean energy balance residual should not exceed a_{1t} etc. Therefore they have appropriate units.

With the CFD parameter the maximum number of iterations in certain fluid loops can be influenced. A fluid calculation within CalculiX is triggered at the start of a new mechanical increment. This increment is subdivided into fluid increments based on the physical fluid properties. For each fluid increment iterations are performed. Usually, iterations are performed until convergence of the fluid increment or until the maximum allowed number of iterations is reached. This is the first parameter *iitt* (“transient”). In fluid calculations the unknowns in the equation systems are the quantities (velocity..) at the element centers. The values at the face centers and the gradients are calculated based on these element center quantities. In case the mesh is not orthogonal, iterations have to be performed. The number of these iterations is expressed by *iitg* (“geometry”) and *iitp* (taking non-orthogonality into account in the pressure correction equation, “pressure”). This is the second and third parameter. For a perfectly rectangular grid these values can be set to zero. Finally, the parameter *jit* specifies how many coupled pressure-temperature iterations have to be performed. For incompressible flow the default value of 1 should not be changed. For inviscid compressible flow this value may have to be increased up to 4, whereas for viscid compressible flow this value has rarely to be changed.

Finally, the CONTACT parameter is used to change defaults in the face-to-face penalty contact convergence algorithm (cf. Section 6.10.2). This relates to

- the maximum relative difference in number of contact elements to allow for convergence (delcon). The corresponding absolute difference, which may not be exceeded is defined as the number of contact elements in the previous iteration times delcon.
- the fraction of contact elements which is removed in an aleatoric way before repeting an increment in case of a local mimimum in the solution (alea)
- the integer factor by which the normal spring stiffness (in case of linear pressure-overclosure) and stick slope are reduced in case of divergence or too slow convergence (kscalemax)
- the maximum number of iterions per increment (itf2f).

First line:

- *CONTROLS
- Enter the PARAMETERS parameter and its value, or the RESET parameter.

There are no subsequent lines if the parameter RESET is selected.

Following lines if PARAMETERS=TIME INCREMENTATION is selected:

Second line:

- I_0 iteration after which a check is made whether the residuals increase in two consecutive iterations (default: 4). If so, the increment is reattempted with D_f times its size.
- I_R iteration after which a logarithmic convergence check is performed in each iteration (default: 8). If more than I_C iterations are needed, the increment is reattempted with D_C its size.
- I_P iteration after which the residual tolerance R_p^α is used instead of R_n^α (default: 9).
- I_C maximum number of iterations allowed (default: 16).
- I_L number of iterations after which the size of the subsequent increment will be reduced (default: 10).
- I_G maximum number of iterations allowed in two consecutive increments for the size of the next increment to be increased (default: 4).
- I_S Currently not used.
- I_A Maximum number of cutbacks per increment (default: 5). A cutback is a reattempted increment.
- I_J Currently not used.

- I_T Currently not used.

Third line:

- D_f Cutback factor if the solution seems to diverge(default: 0.25).
- D_C Cutback factor if the logarithmic extrapolation predicts too many iterations (default: 0.5).
- D_B Cutback factor for the next increment if more than I_L iterations were needed in the current increment (default: 0.75).
- D_A Cutback factor if the temperature change in two subsequent increments exceeds DELTMX (default: 0.85).
- D_S Currently not used.
- D_H Currently not used.
- D_D Factor by which the next increment will be increased if less than I_G iterations are needed in two consecutive increments (default: 1.5).
- W_G Currently not used.

Following line if PARAMETERS=FIELD is selected:

Second line:

- R_n^α Convergence criterion for the ratio of the largest residual to the average force (default: 0.005). The average force is defined as the average over all increments in the present step of the instantaneous force. The instantaneous force in an increment is defined as the mean of the absolute value of the nodal force components within all elements.
- C_n^α Convergence criterion for the ratio of the largest solution correction to the largest incremental solution value (default: 0.01).
- q_0^α Initial value at the start of a new step of the time average force (default: the time average force from the previous steps or 0.01 for the first step).
- q_u^α user-defined average force. If defined, the calculation of the average force is replaced by this value.
- R_p^α Alternative residual convergence criterion to be used after I_P iterations instead of R_n^α (default: 0.02).
- ϵ^α Criterion for zero flux relative to q^α (default: 10^{-5}).
- C_ϵ^α Convergence criterion for the ratio of the largest solution correction to the largest incremental solution value in case of zero flux (default: 10^{-3}).
- R_l^α Convergence criterion for the ratio of the largest residual to the average force for convergence in a single iteration (default: 10^{-8}).

Following line if PARAMETERS=LINE SEARCH is selected:

Second line:

- not used.
- s_{max}^{ls} Maximum value of the line search parameter (default: 1.01).
- s_{min}^{ls} Minimum value of the line search parameter (default: 0.25).
- not used.
- not used.

Following line if PARAMETERS=NETWORK is selected:

Second line:

- c_{1t} (default: $5 \cdot 10^{-7}$).
- c_{1f} (default: $5 \cdot 10^{-7}$).
- c_{1p} (default: $5 \cdot 10^{-7}$).
- c_{2t} (default: $5 \cdot 10^{-7}$).
- c_{2f} (default: $5 \cdot 10^{-7}$).
- c_{2p} (default: $5 \cdot 10^{-7}$).
- c_{2a} (default: $5 \cdot 10^{-7}$).

Third line:

- a_{1t} (default: $10^{20}[\text{M}][\text{L}]^2/[\text{t}]^3$; unit in SI: Watt).
- a_{1f} (default: $10^{20}[\text{M}]/[\text{t}]$; unit in SI: kg/s).
- a_{1p} (default: $10^{20}[-]$; dimensionless).
- a_{2t} (default: $10^{20}[\text{T}]$; unit in SI: K).
- a_{2f} (default: $10^{20}[\text{M}]/[\text{t}]$; unit in SI: kg/s).
- a_{2p} (default: $10^{20}[\text{M}]/([\text{t}]^2[\text{L}])$; unit in SI: Pa).
- a_{2a} (default: $10^{20}[\text{L}]$; unit in SI: m).

Here, [M], [L], [T] and [t] are the units for mass, length, temperature and time.

Following line if PARAMETERS=CFD is selected:

Second line:

- $iitt$ (default: 20).
- itg (default: 0).

- *iitp* (default: 1).
- *jit* (default: 1).

Following line if PARAMETERS=CONTACT is selected:
Second line:

- *delcon* (≥ 0 ; default: 0.001).
- *alea* ($0 \leq \text{alea} \leq 1$; default: 0.1).
- *kscalemax* (≥ 1 , integer; default: 100).
- *itf2f* (≥ 1 , integer; default: 60).

Example:

```
*CONTROLS,PARAMETERS=FIELD
1.e30,1.e30,0.01,,0.02,1.e-5,1.e-3,1.e-8
```

leads to convergence in just one iteration since nearly any residuals are accepted for convergence ($R_n^\alpha = 10^{30}$ and $C_n^\alpha = 10^{30}$).

Example files: beammrco.

7.25 *CORRELATION LENGTH

Keyword type: step

This option is used to define the correlation length to be used to calculate the random fields in a *ROBUST DESIGN analysis. It has the unit of length and is a measure for how connected the outer geometry is. A small correlation length means that the surface finish of the structure allows for high frequency geometric deviations such as very local dents. A large correlation length allows only for low frequency deviations, i.e. any deviations are rather smooth and extend over a larger area. A small correlation length will require a larger set of random field vectors to represent the geometric tolerances to a given accuracy.

First line:

- *CORRELATION LENGTH

Second line:

- correlation length

Example:

```
*CORRELATION LENGTH
20.
```

specifies a correlation length of 20 length units.

Example files: beamprand.

7.26 *COUPLED TEMPERATURE-DISPLACEMENT

Keyword type: step

This procedure is used to perform a coupled thermomechanical analysis. A thermomechanical analysis is a nonlinear calculation in which the displacements and temperatures are simultaneously solved. In this way the reciprocal action of the temperature on the displacements and the displacements on the temperature can be taken into account. At the present state, the influence of the temperature on the displacements is calculated through the thermal expansion, the effect of the displacements on the temperature is limited to radiation effects. In addition, the influence of the network fluid pressure on the deformation of a structure and the influence of the structural deformation on the network fluid mass flow can be considered. Other heating effects, e.g. due to plasticity, or not yet taken into account.

The coupling is not done on matrix level, i.e. the left hand side matrix of the equation system does not contain any coupling terms. The coupling is rather done by an update of the boundary conditions after each iteration. Indeed, the calculation of an increment usually requires several iterations to obtain convergence. By including the thermomechanical interaction after each iteration it is automatically taken into account at convergence of the increment.

There are eight optional parameters: SOLVER, DIRECT, ALPHA, STEADY STATE, DELTMX, TIME RESET, TOTAL TIME AT START and COMPRESSIBLE.

SOLVER determines the package used to solve the ensuing system of equations. The following solvers can be selected:

- the SGI solver
- PaStiX
- PARDISO
- SPOOLES [3, 4].
- TAUCS
- the iterative solver by Rank and Ruecker [79], which is based on the algorithms by Schwarz [85].

Default is the first solver which has been installed of the following list: SGI, PaStiX, PARDISO, SPOOLES and TAUCS. If none is installed, the default is the iterative solver, which comes with the CalculiX package.

The SGI solver should by now be considered as outdated. SPOOLES is very fast, but has no out-of-core capability: the size of systems you can solve is limited by your RAM memory. With 32GB of RAM you can solve up to 1,000,000 equations. TAUCS is also good, but my experience is limited to the LL^T decomposition, which only applies to positive definite systems. It has an out-of-core capability and also offers a LU decomposition, however, I was not able to run

either of them so far. PARDISO is the Intel proprietary solver and is about a factor of two faster than SPOOLES. The most recent solver we tried is the freeware solver PaStiX from INRIA. It is really fast and can use the GPU. For large problems and a high end Nvidia graphical card (32 GB of RAM) we got an acceleration of a factor between 3 and 8 compared to PARDISO. We modified PaStiX for this, therefore you have to download PaStiX from our website and compile it for your system. This can be slightly tricky, however, it is worth it!

What about the iterative solver? If SOLVER=ITERATIVE SCALING is selected, the pre-conditioning is limited to a scaling of the diagonal terms, SOLVER=ITERATIVE CHOLESKY triggers Incomplete Cholesky pre-conditioning. Cholesky pre-conditioning leads to a better convergence and maybe to shorter execution times, however, it requires additional storage roughly corresponding to the non-zeros in the matrix. If you are short of memory, diagonal scaling might be your last resort. The iterative methods perform well for truly three-dimensional structures. For instance, calculations for a hemisphere were about nine times faster with the ITERATIVE SCALING solver, and three times faster with the ITERATIVE CHOLESKY solver than with SPOOLES. For two-dimensional structures such as plates or shells, the performance might break down drastically and convergence often requires the use of Cholesky pre-conditioning. SPOOLES (and any of the other direct solvers) performs well in most situations with emphasis on slender structures but requires much more storage than the iterative solver.

The parameter DIRECT indicates that automatic incrementation should be switched off. The increments will have the fixed length specified by the user on the second line.

The parameter ALPHA takes an argument between -1/3 and 0. It controls the dissipation of the high frequency response: lower numbers lead to increased numerical damping ([62]). The default value is -0.05.

The parameter STEADY STATE indicates that only the steady state should be calculated. If this parameter is absent, the calculation is assumed to be time dependent and a transient analysis is performed. For a transient analysis the specific heat of the materials involved must be provided. In a steady state analysis any loading is applied using linear ramping, in a transient analysis step loading is applied.

The parameter DELTMX can be used to limit the temperature change in two subsequent increments. If the temperature change exceeds DELTMX the increment is restarted with a size equal to D_A times DELTMX divided by the temperature change. The default for D_A is 0.85, however, it can be changed by the *CONTROLS keyword. DELTMX is only active in transient calculations. Default value is 10^{30} .

The parameter TIME RESET can be used to force the total time at the end of the present step to coincide with the total time at the end of the previous step. If there is no previous step the targeted total time is zero. If this parameter is absent the total time at the end of the present step is the total time at the end of the previous step plus the time period of the present step (2nd parameter underneath the *COUPLED TEMPERATURE-DISPLACEMENT keyword).

Consequently, if the time at the end of the previous step is 10. and the present time period is 1., the total time at the end of the present step is 11. If the TIME RESET parameter is used, the total time at the beginning of the present step is 9. and at the end of the present step it will be 10. This is sometimes useful if transient coupled temperature-displacement calculations are preceded by a stationary heat transfer step to reach steady state conditions at the start of the transient coupled temperature-displacement calculations. Using the TIME RESET parameter in the stationary step (the first step in the calculation) will lead to a zero total time at the start of the subsequent instationary step.

The parameter TOTAL TIME AT START can be used to set the total time at the start of the step to a specific value.

Finally, the parameter COMPRESSIBLE is only used in 3-D CFD calculations. It specifies that the fluid is compressible. Default is incompressible.

First line:

- *COUPLED TEMPERATURE-DISPLACEMENT
- Enter any needed parameters and their values.
- Initial time increment. This value will be modified due to automatic incrementation, unless the parameter DIRECT was specified (default 1.).
- Time period of the step (default 1.).
- Minimum time increment allowed. Only active if DIRECT is not specified. Default is the initial time increment or 1.e-5 times the time period of the step, whichever is smaller.
- Maximum time increment allowed. Only active if DIRECT is not specified. Default is 1.e+30.
- Initial time increment for CFD applications (default 1.e-2)

Example:

```
*COUPLED TEMPERATURE-DISPLACEMENT
.1,1.
```

defines a thermomechanical step and selects the SPOOLES solver as linear equation solver in the step (default). The second line indicates that the initial time increment is .1 and the total step time is 1.

Example files: thermomech.

7.27 *COUPLING

Keyword type: model definition

This option is used to generate a kinematic or a distributing coupling. It must be followed by the keyword *KINEMATIC or *DISTRIBUTING.

The parameters REF NODE, SURFACE and CONSTRAINT NAME are mandatory, the parameter ORIENTATION is optional.

With REF NODE a reference node is chosen, the degrees of freedom of which are used to define the constraint. In the reference node six degrees of freedom are available: 1 to 3 for translations in the x-, y- and z- direction and 4 to 6 for rotations about the x-, y- and z- axis. For *KINEMATIC couplings the location of the reference node determines the center of the rigid motion. For *DISTRIBUTING couplings any forces specified by the user are applied at the location of the reference node. Choosing another reference node will change the effect of these forces (e.g. the moment about the center of gravity of the coupling surface will be different). The reference node should not be one of the nodes of the surface to which the constraint applies.

With SURFACE the nodes are selected to which the constraint applies (so-called coupling nodes). This surface must be face-based.

The parameter CONSTRAINT NAME is used to assign a name to the coupling condition. This name is not used so far.

Finally, with the ORIENTATION parameter one can assign a local coordinate system to the coupling constraint. Notice that this does not induce a change of coordinate system in the reference node (for this a *TRANSFORM card is needed). For distributing couplings only rectangular local systems are allowed, for kinematic couplings both rectangular and cylindrical systems are allowed, cf. *ORIENTATION.

For *DISTRIBUTING couplings it is not recommended to apply any other forces but the forces and/or moments in the reference node to any node belonging to the coupling surface and no transformation is allowed in these nodes. Furthermore, it is not recommended to use the reference node in any other construct.

First line:

- *COUPLING
- Enter any needed parameters.

Example:

```
*COUPLING,REF NODE=200,SURFACE=SURF,CONSTRAINT NAME=C1,ORIENTATION=OR1
```

defines a coupling constraint with name C1 for the nodes belonging to the surface SURF. The reference node is node 200 and an orientation OR1 was applied.

Example files: coupling1.

7.28 *CRACK PROPAGATION

Keyword type: step

This procedure is used to perform a crack propagation analysis. Prerequisite is the performance of a static calculation for the uncracked structure, which may consist of several steps. The results of this calculation must be stored in a frd-file. The crack propagation calculation must be done in a separate input deck. The model in this input deck should contain a triangulation of the crack(s) with S3 shell elements. It may also contain the mesh of the uncracked structure.

There are two required parameters INPUT and MATERIAL and one optional parameter LENGTH. With the parameter INPUT the frd-file with the uncracked results is referenced. It should contain stresses and may, in addition, contain temperatures for all steps of the uncracked calculation. The parameter MATERIAL refers to the material definition containing the crack propagation parameters. Right now, a Paris-type law with threshold and critical corrections is available, cf. Section 6.9.27.

The LENGTH parameter indicates how the crack length is to be calculated:

- CUMULATIVE means that the crack length is the crack length of the initial crack augmented by the crack propagation increments of the subsequent increments
- INTERSECTION means that the crack length at a certain location along the crack front is determined by the distance from the point on the crack front opposite to this location.

Since the jobname.frd file is created from scratch in every *CRACK PROPAGATION step (this is because every *CRACK PROPAGATION step changes the number of nodes and elements in the model due to the growing crack) it does not make sense to have more than one such step in an input deck. In fact, any other step is senseless and ideally the *CRACK PROPAGATION step should be the only step in the deck. If the user defines more than one *CRACK PROPAGATION step in his/her input deck, the jobname.frd file will only contain the output requested, if any, from the last *CRACK PROPAGATION step. This rule also applies to restart calculations.

First line:

- *CRACK PROPAGATION
- Enter any parameters and their value

Second line:

- Maximum crack propagation increment.
- Maximum deflection angle per increment.

Example:

```
*MATERIAL,NAME=CRACK
*USER MATERIAL,CONSTANTS=8
1.E-4,772.86,3.1,10.,177.09,10.,3162.,0.5
...
*STEP,INC=50
*CRACK PROPAGATION,INPUT=master.frd,MATERIAL=CRACK,LENGTH=CUMULATIVE
0.05,10.
```

defines a crack propagation calculation. The results of the uncracked calculation are stored in master.frd. The propagation data are defined underneath the material definition for material CRACK. The crack length calculation is based on a sum of the initial crack length and the subsequent crack increments. The maximum crack length increment is 0.05 length units, the maximum deflection angle per increment is 10°. The maximum number of increments is defined using the INC parameter on the *STEP card.

Example files: crackIIcum, crackIIint, crackIIprin.

7.29 *CREEP

Keyword type: model definition, material

This option is used to define the creep properties of a viscoplastic material. There is one optional parameter LAW. Default is LAW=NORTON, the only other value is LAW=USER for a user-defined creep law. The Norton law satisfies:

$$\dot{\epsilon} = A\sigma^n t^m \quad (851)$$

where ϵ is the equivalent creep strain, σ is the true Von Mises stress and t is the total time. For LAW=USER the creep law must be defined in user subroutine creep.f (cf. Section 8.1).

All constants may be temperature dependent. The card should be preceded by a *ELASTIC card within the same material definition, defining the elastic properties of the material. If for LAW=NORTON the temperature data points under the *CREEP card are not the same as those under the *ELASTIC card, the creep data are interpolated at the *ELASTIC temperature data points. If a *PLASTIC card is defined within the same material definition, it should be placed after the *ELASTIC and before the *CREEP card. If no *PLASTIC card is found, a zero yield surface without any hardening is assumed.

If the elastic data is isotropic, the large strain viscoplastic theory treated in [89] and [90] is applied. If the elastic data is orthotropic, the infinitesimal strain model discussed in Section 6.8.16 is used. If a *PLASTIC card is used for an orthotropic material, the LAW=USER option is not available.

First line:

- *CREEP
- Enter the LAW parameter and its value, if needed

Following lines are only needed for LAW=NORTON (default): First line:

- A.
- n.
- m.
- Temperature.

Use as many lines as needed to define the complete temperature dependence.

Example:

```
*CREEP
1.E-10,5.,0.,100.
2.E-10,5.,0.,200.
```

defines a creep law with $A=10^{-10}$, $n=5$ and $m=0$ for $T(\text{temperature})=100$. and $A=2 \cdot 10^{-10}$ and $n=5$ for $T(\text{temperature})=200$.

Example files: beamcr.

7.30 *CYCLIC HARDENING

Keyword type: model definition,material

This option is used to define the isotropic hardening curves of an incrementally plastic material with combined hardening. All constants may be temperature dependent. The card should be preceded by an *ELASTIC card within the same material definition, defining the isotropic elastic properties of the material.

If the elastic data is isotropic, the large strain viscoplastic theory treated in [89] and [90] is applied. If the elastic data is orthotropic, the infinitesimal strain model discussed in Section 6.8.16 is used. Accordingly, for an elastically orthotropic material the hardening can be at most linear. Furthermore, if the temperature data points for the hardening curves do not correspond to the *ELASTIC temperature data points, they are interpolated at the latter points. Therefore, for an elastically isotropic material, it is advisable to define the hardening curves at the same temperatures as the elastic data.

Please note that, for each temperature, the (von Mises stress, equivalent plastic strain) data have to be entered in ascending order of the equivalent plastic strain.

First line:

- *CYCLIC HARDENING

Following sets of lines defines the isotropic hardening curve: First line in the first set:

- Von Mises stress.
- Equivalent plastic strain.
- Temperature.

Use as many lines in the first set as needed to define the complete hardening curve for this temperature.

Use as many sets as needed to define complete temperature dependence.

Example:

```
*CYCLIC HARDENING
800.,0.,100.
1000.,.1,100.
900.,0.,500.
1050.,.11,500.
```

defines two (stress,plastic strain) data points at T=100. and two data points at T=500. Notice that the temperature must be listed in ascending order. The same is true for the plastic strain within a temperature block.

Example files: beampik.

7.31 *CYCLIC SYMMETRY MODEL

Keyword type: model definition

This keyword is used to define the number of sectors and the axis of symmetry in a cyclic symmetric structure for use in a cyclic symmetry calculation (structural or 3D-fluid).

It must be preceded by two *SURFACE cards defining the nodes belonging to the left and right boundary of the sector and a *TIE card linking those surfaces. The axis of symmetry is defined by two points a and b, defined in global Cartesian coordinates.

For structural calculations there are six parameters, N, NGRAPH, TIE, ELSET, MATRIX and CHECK. The parameter N, specifying the number of sectors, is required, TIE is required if more than one cyclic symmetry tie is defined.

The parameter NGRAPH is optional and indicates for how many sectors the solutions should be stored in .frd format. Setting NGRAPH=N for N sectors stores the solution for the complete structure for subsequent plotting purposes. Default is NGRAPH=1. The rotational direction for the multiplication of the datum sector is from the dependent surface (slave) to the independent surface (master).

The parameter TIE specifies the name of the tie constraint to which the cyclic symmetry model definition applies. It need not be specified if only one *TIE card has been defined.

The element set specified by ELSET specifies the elements to which the parameter NGRAPH should be applied. Default if only one cyclic symmetry *TIE card is used in the input deck is the complete model.

The MATRIX parameter is needed if a substructure, the matrices for which were read from file, is present in the model. The value of MATRIX is the name of the matrix, which contains at most 4 characters, e.g. MATRIX=TEST for a substructure with the name TEST. The parameters ELSET and MATRIX are mutually exclusive.

The last parameter, CHECK, specifies whether CalculiX should compare the sector angle based on its geometry with its value based on N. If the deviation exceeds 0.01 radians the program issues an error message and stops. If CHECK=NO is specified, the check is not performed, else it is. If the user wants to find eigenmodes with fractional nodal diameters, i.e. vibrations for which the phase shift is smaller than the sector angle, a value of N has to be specified which exceeds the number of sectors in the model. In that case the check should be turned off. Notice that in the case of the check being turned off the sector angle based on the geometry is still calculated for other purposes, it is just not compared to the sector angle based on the value of N.

Several *CYCLIC SYMMETRY MODEL cards within one input deck defining several cyclic symmetries about the same axis within one and the same model are allowed. This, however, always is an approximation, since several cyclic symmetries within one model cannot really exist. Good results are only feasible if the values of N for the different *CYCLIC SYMMETRY MODEL cards do not deviate substantially.

The *CYCLIC SYMMETRY MODEL card triggers the creation of cyclic symmetry multiple point constraints between the slave and master side. If the nodes do not match on a one-to-one basis a slave node is connected to a master face. To this end the master side is triangulated. The resulting triangulation is stored in file TriMasterCyclicSymmetryModel.frd and can be viewed with CalculiX GraphiX.

First line for all but fluid periodic calculations:

- *CYCLIC SYMMETRY MODEL
- Enter the required parameters N and TIE (the latter only if more than one cyclic symmetry tie is defined) and their value.

Second line:

- X-coordinate of point a.
- Y-coordinate of point a.
- Z-coordinate of point a.

- X-coordinate of point b.
- Y-coordinate of point b.
- Z-coordinate of point b.

Example:

```
*CYCLIC SYMMETRY MODEL, N=12, NGRAPH=3
0.,0.,0.,1.,0.,0.
```

defines a cyclic symmetric structure consisting of 30° sectors and axis of symmetry through the points (0.,0.,0.) and (1.,0.,0.). The solution will be stored for three connected sectors (120°).

Example files: segment, fullseg, couette1per, couettecyl4.

7.32 *DAMPING

Keyword type: model definition, if structural damping: material

This card is used to define Rayleigh damping for implicit and explicit dynamic calculations (*DYNAMIC) and structural damping for steady state dynamics calculations (*STEADY STATE DYNAMICS).

For Rayleigh damping there are two required parameters: ALPHA and BETA.

Rayleigh damping is applied in a global way, i.e. the damping matrix $[C]$ is taken to be a linear combination of the stiffness matrix $[K]$ and the mass matrix $[M]$:

$$[C] = \alpha [M] + \beta [K]. \quad (852)$$

The damping force satisfies:

$$\{F\} = [C] \{v\}, \quad (853)$$

where $\{v\}$ is the velocity vector. For Rayleigh damping only one *DAMPING card can be used in the input deck. It applies to the whole model.

For explicit dynamic calculations only mass proportional damping is allowed, i.e. β must be zero.

For structural damping the damping is a material characteristic. Each material can have its own damping value. There is one required parameter STRUCTURAL, defining the value ζ of the damping. For structural damping the element damping force is displacement dependent and satisfies:

$$\{F\}_e = i\zeta_e [K]_e \{x\}_e, \quad (854)$$

where $i = \sqrt{-1}$, $[K]_e$ is the element stiffness matrix, and $\{x\}_e$ is the element displacement vector. ζ_e is the structural damping value for the material of element e (default is zero). The global damping force is assembled from the element damping forces.

First line:

- *DAMPING
- Enter ALPHA and BETA and their values for Rayleigh damping or STRUCTURAL and its value for structural damping.

Example:

```
*DAMPING,ALPHA=5000.,BETA=2.e-3
```

indicates that a damping matrix is created by multiplying the mass matrix with 5000. and adding it to the stiffness matrix multiplied by $2 \cdot 10^{-4}$

Example:

```
*DAMPING,STRUCTURAL=0.03
```

defines a structural damping value of 0.03 (3 %). This card must be part of a material description.

Example files: beamimpdy1, beamimpdy2.

7.33 *DASHPOT

Keyword type: model definition

With this option the force-velocity relationship can be defined for dashpot elements. Dashpot elements only make sense for dynamic calculations (implicit *DYNAMIC, *MODAL DYNAMIC and *STEADY STATE DYNAMICS). For explicit *DYNAMIC calculations they have not been implemented yet. There is one required parameter ELSET. With this parameter the element set is referred to for which the dashpot behavior is defined. This element set should contain dashpot elements of type DASHPOTA only.

The dashpot constant can depend on frequency and temperature. Frequency dependence only makes sense for *STEADY STATE DYNAMICS calculations.

First line:

- *DASHPOT
- Enter the parameter ELSET and its value

Second line: enter a blank line

For each temperature a set of lines can be entered. First line in the first set:

- Dashpot constant.
- Frequency (only for steady state dynamics calculations, else blank).
- Temperature.

Use as many lines in the first set as needed to define the complete frequency dependence of the dashpot constant (if applicable) for this temperature. Use as many sets as needed to define complete temperature dependence.

Example:

```
*DASHPOT,ELSET=Eall
1.e-5
```

defines a dashpot constant with value 10^{-5} for all elements in element set Eall and all temperatures.

Example:

```
*DASHPOT,ELSET=Eall
1.e-5,1000.,273.
1.e-6,2000.,273.
1.e-4,,373.
```

defines a dashpot constant with value 10^{-5} at a frequency of 1000 and with value 10^{-6} at a frequency of 2000, both at a temperature of 273. At a temperature of 373 the dashpot constant is frequency independent and takes the value 10^{-4} . These constants apply to all dashpot elements in set Eall.

Example files: dashpot1, dashpot2, dashpot3.

7.34 *DEFORMATION PLASTICITY

Keyword type: model definition, material

This option defines the elasto-plastic behavior of a material by means of the generalized Ramberg-Osgood law. The one-dimensional model takes the form:

$$E\epsilon = \sigma + \alpha \left(\frac{|\sigma|}{\sigma_0} \right)^{n-1} \sigma \quad (855)$$

where ϵ is the logarithmic strain and σ the Cauchy stress. In the present implementation, the Eulerian strain is used, which is very similar to the logarithmic strain (about 1.3 % difference at 20 % engineering strain). All coefficients may be temperature dependent.

First line:

- *DEFORMATION PLASTICITY

Following line:

- Young's modulus (E).
- Poisson's ratio (ν).
- Yield stress (σ_0)
- Exponent (n).
- Yield offset (α).
- Temperature.

Repeat this line if needed to define complete temperature dependence.

Example:

```
*DEFORMATION PLASTICITY
210000.,.3,800.,12.,0.4
```

defines a Ramberg-Osgood law. No temperature dependence is introduced.

Example files: beampl.

7.35 *DENSITY

Keyword type: model definition, material

With this option the mass density of a material can be defined. The mass density is required for a frequency analysis (*FREQUENCY), for a dynamic analysis (*DYNAMIC or *HEAT TRANSFER) and for a static analysis with gravity loads (GRAV) or centrifugal loads (CENTRIF). The density can be temperature dependent.

First line:

- *DENSITY

Following line:

- Mass density.
- Temperature.

Repeat this line if needed to define complete temperature dependence.

Example:

```
*DENSITY
7.8E-9
```

defines a density with value 7.8×10^{-9} for all temperatures.

Example files: achtelc, segment1, segment2, beamf.

7.36 *DEPVAR

Keyword type: model definition, material

This keyword is used to define the number of internal state variables for a user-defined material. They are initialized to zero at the start of the calculation and can be used within a material user subroutine. There are no parameters. This card must be preceded by a *USER MATERIAL card.

First line:

- *DEPVAR

Second line:

- Number of internal state variables.

Example:

```
*DEPVAR
12
```

defines 12 internal state variables for the user-defined material at stake.

Example files: .

7.37 *DESIGN RESPONSE

Keyword type: step

With *DESIGN RESPONSE one can define the design response functions in a sensitivity analysis. Right now the following design response functions are allowed for TYPE=COORDINATE design variables:

- ALL-DISP: the square root of the sum of the square of the displacements in all nodes of the structure or of a subset if a node set is defined
- x-DISP: the square root of the sum of the square of the x-displacements in all nodes of the structure or of a subset if a node set is defined
- Y-DISP: the square root of the sum of the square of the y-displacements in all nodes of the structure or of a subset if a node set is defined
- Z-DISP: the square root of the sum of the square of the z-displacements in all nodes of the structure or of a subset if a node set is defined
- EIGENFREQUENCY: all eigenfrequencies calculated in a previous *FREQUENCY step (actually the eigenvalues, which are the square of the eigenfrequencies)
- MASS: mass of the total structure or of a subset if an element set is defined

- STRAIN ENERGY: internal energy of the total structure or of a subset if an element set is defined
- MISESSTRESS: the maximum von Mises stress of the total structure or of a subset if a node set is defined. The maximum is approximated by the Kreisselmeier-Steinhauser function

$$f = \frac{1}{\rho} \ln \sum_i e^{\rho \frac{\sigma_i}{\bar{\sigma}}}, \quad (856)$$

where σ_i is the von Mises stress in node i , ρ and $\bar{\sigma}$ are user-defined parameters. The higher ρ the closer f is to the actual maximum (a value of 10 is recommended; the higher this value, the sharper the turns in the function). $\bar{\sigma}$ is the target stress, it should not be too far away from the actual maximum. The target stress must be positive.

- PS1STRESS: the maximum of the highest principal stress of the total structure or of a subset if a node set is defined. The maximum is approximated by the Kreisselmeier-Steinhauser function (cf. MISESSTRESS above, also here the target stress must be positive).
- PS3STRESS: the minimum of the lowest principal stress of the total structure or of a subset if a node set is defined. The minimum is approximated by the Kreisselmeier-Steinhauser function. The target stress for PS3STRESS must be negative.
- MODALSTRESS: the maximum von Mises modal stress of the total structure or of a subset if a node set is defined. The maximum is approximated by the Kreisselmeier-Steinhauser function.
- EQUIVALENT PLASTIC STRAIN: the maximum equivalent plastic strain of the total structure or of a subset if a node set is defined. The maximum is approximated by the Kreisselmeier-Steinhauser function. The target equivalent plastic strain must be positive.

and for TYPE=ORIENTATION design variables:

- ALL-DISP: the displacements in all nodes.
- EIGENFREQUENCY: all eigenfrequencies (actually the eigenvalues, which are the square of the eigenfrequencies) and eigenmodes calculated in a previous *FREQUENCY step.
- GREEN: the Green functions calculated in a previous *GREEN step.
- MASS: mass of the total structure or of a subset if an element set is defined
- STRAIN ENERGY: internal energy of the total structure or of a subset if an element set is defined

- MISESSTRESS: the von Mises stress in all nodes.

There is one parameter NAME which is compulsory for TYPE=COORDINATE design variables and not used for TYPE=ORIENTATION design variables. It is used for the sake of choosing design responses for the objective and/or constraints in an optimization. It should not be longer than 80 characters.

Exactly one *DESIGN RESPONSE keyword is required in a *SENSITIVITY step of type ORIENTATION. This keyword has to be followed by at least one design response function.

For a *SENSITIVITY step of type COORDINATE at least one *DESIGN RESPONSE keyword is required. This keyword has to be followed by exactly one design response function.

First line:

- *DESIGN RESPONSE.
- specify the parameter NAME and its value for TYPE=COORDINATE design variables.

Second line:

- a response function
- an element or node set, if appropriate
- ρ for the Kreisselmeier-Steinhauser function (only for the coordinates as design variables and the stress or strain as target)
- $\bar{\sigma}$ for the Kreisselmeier-Steinhauser function (only for the coordinates as design variables and the stress or strain as target)

Repeat this line if needed.

The design response functions STRAIN ENERGY, MASS, ALL-DISP, MISESSTRESS, PS1STRESS, PS3STRESS and EQUIVALENT PLASTIC STRAIN require a *STATIC step before the *SENSITIVITY step, the design response function EIGENFREQUENCY requires a *FREQUENCY step immediately preceding the *SENSITIVITY step and the design response function GREEN requires a *GREEN step before the *SENSITIVITY step. Therefore, the {STRAIN ENERGY, MASS, ALL-DISP, MISESSTRESS, PS1STRESS, PS3STRESS} design response functions, the {EIGENFREQUENCY} design response function and the {GREEN} design response function are mutually exclusive within one and the same *SENSITIVITY step.

Example:

```
*DESIGN RESPONSE
ALL-DISP,N1
```

defines the square root of the sum of the square of the displacements in set N1 to be the design response function.

Example files: sensitivity.I.

7.38 *DESIGN VARIABLES

Keyword type: model definition

This option is used to define the design variables for a sensitivity study. The parameter TYPE is required and can take the value COORDINATE or ORIENTATION. In case of COORDINATE a second line is needed to define the nodes whose coordinates are to be changed. These nodes should be part of the surface of the structure (a change in position of nodes internal to the structure does not change the geometry). They will be varied in a direction locally orthogonal to the structure (in-surface motions do not change the geometry). In the case of ORIENTATION the sensitivity of all orientations expressed by *ORIENTATION cards is calculated successively.

This keyword card should only occur once in the input deck. If it occurs more than once only the first occurrence is taken into account.

First line:

- *DESIGN VARIABLES
- Enter the TYPE parameter and its value.

Following line if TYPE=COORDINATE:

- Node set containing the design variables.

Example:

```
*DESIGN VARIABLES,TYPE=COORDINATE
N1
```

defines the set N1 as the node set containing the design variables.

Example files: sensitivity_I.

7.39 *DFLUX

Keyword type: step

This option allows the specification of distributed heat fluxes. These include surface flux (energy per unit of surface per unit of time) on element faces and volume flux in bodies (energy per unit of volume per unit of time).

In order to specify which face the flux is entering or leaving the faces are numbered. The numbering depends on the element type.

For hexahedral elements the faces are numbered as follows (numbers are node numbers):

- Face 1: 1-2-3-4
- Face 2: 5-8-7-6
- Face 3: 1-5-6-2

- Face 4: 2-6-7-3
- Face 5: 3-7-8-4
- Face 6: 4-8-5-1

for tetrahedral elements:

- Face 1: 1-2-3
- Face 2: 1-4-2
- Face 3: 2-4-3
- Face 4: 3-4-1

for wedge elements:

- Face 1: 1-2-3
- Face 2: 4-5-6
- Face 3: 1-2-5-4
- Face 4: 2-3-6-5
- Face 5: 3-1-4-6

for quadrilateral plane stress, plane strain and axisymmetric elements:

- Face 1: 1-2
- Face 2: 2-3
- Face 3: 3-4
- Face 4: 4-1
- Face N: in negative normal direction (only for plane stress)
- Face P: in positive normal direction (only for plane stress)

for triangular plane stress, plane strain and axisymmetric elements:

- Face 1: 1-2
- Face 2: 2-3
- Face 3: 3-1
- Face N: in negative normal direction (only for plane stress)
- Face P: in positive normal direction (only for plane stress)

for quadrilateral shell elements:

- Face NEG or 1: in negative normal direction
- Face POS or 2: in positive normal direction
- Face 3: 1-2
- Face 4: 2-3
- Face 5: 3-4
- Face 6: 4-1

for triangular shell elements:

- Face NEG or 1: in negative normal direction
- Face POS or 2: in positive normal direction
- Face 3: 1-2
- Face 4: 2-3
- Face 5: 3-1

The labels NEG and POS can only be used for uniform flux and are introduced for compatibility with ABAQUS. Notice that the labels 1 and 2 correspond to the brick face labels of the 3D expansion of the shell (Figure 69).

for beam elements:

- Face 1: in negative 1-direction
- Face 2: in positive 1-direction
- Face 3: in positive 2-direction
- Face 5: in negative 2-direction

The beam face numbers correspond to the brick face labels of the 3D expansion of the beam (Figure 74).

The surface flux is entered as a uniform flux with distributed flux type label S_x where x is the number of the face. For flux entering the body the magnitude of the flux is positive, for flux leaving the body it is negative. If the flux is nonuniform the label takes the form S_xNUy and a user subroutine `dflux.f` must be provided specifying the value of the flux. The label can be up to 20 characters long. In particular, y can be used to distinguish different nonuniform flux patterns (maximum 16 characters).

For body generated flux (energy per unit of time per unit of volume) the distributed flux type label is BF for uniform flux and $BFNUy$ for nonuniform flux. For nonuniform flux the user subroutine `dflux` must be provided. Here too, y can be used to distinguish different nonuniform body flux patterns (maximum 16 characters).

Optional parameters are OP, AMPLITUDE and TIME DELAY. OP takes the value NEW or MOD. OP=MOD is default and implies that the surface fluxes on different faces in previous steps are kept. Specifying a distributed flux on a face for which such a flux was defined in a previous step replaces this value, if a flux was defined for the same face within the same step it is added. OP=NEW implies that all previous surface flux is removed. If multiple *DFLUX cards are present in a step this parameter takes effect for the first *DFLUX card only.

The AMPLITUDE parameter allows for the specification of an amplitude by which the flux values are scaled (mainly used for dynamic calculations). Thus, in that case the values entered on the *DFLUX card are interpreted as reference values to be multiplied with the (time dependent) amplitude value to obtain the actual value. At the end of the step the reference value is replaced by the actual value at that time. In subsequent steps this value is kept constant unless it is explicitly redefined or the amplitude is defined using TIME=TOTAL TIME in which case the amplitude keeps its validity. The AMPLITUDE parameter has no effect on nonuniform fluxes.

The TIME DELAY parameter modifies the AMPLITUDE parameter. As such, TIME DELAY must be preceded by an AMPLITUDE name. TIME DELAY is a time shift by which the AMPLITUDE definition it refers to is moved in positive time direction. For instance, a TIME DELAY of 10 means that for time t the amplitude is taken which applies to time $t-10$. The TIME DELAY parameter must only appear once on one and the same keyword card.

Notice that in case an element set is used on any line following *DFLUX this set should not contain elements from more than one of the following groups: {plane stress, plane strain, axisymmetric elements}, {beams, trusses}, {shells, membranes}, {volumetric elements}.

In order to apply a distributed flux to a surface the element set label underneath may be replaced by a surface name. In that case the “x” in the flux type label is left out.

If more than one *DFLUX card occurs within the input deck the following rules apply:

If a *DFLUX with label S1 up to S6 or BF is applied to an element for which a *DFLUX with the SAME label was already applied before, then

- if the previous application was in the same step the flux value is added, else it is replaced
- the new amplitude (including none) overwrites the previous amplitude

First line:

- *DFLUX
- Enter any needed parameters and their value

Following line for surface flux:

- Element number or element set label.

- Distributed flux type label.
- Actual magnitude of the load (power per unit of surface).

Repeat this line if needed.

Following line for body flux:

- Element number or element set label.
- Distributed flux type label (BF or BFNU).
- Actual magnitude of the load (power per unit of volume).

Repeat this line if needed.

Example:

```
*DFLUX,AMPLITUDE=A1
20,S1,10.
```

assigns a flux entering the surface with magnitude 10 times the value of amplitude A1 to surface 1 of element 20.

Example:

```
*DFLUX
15,BF,10.
```

assigns a body flux with magnitude 10. to element 15.

Example files: oneel20df,beamhtbf,oneel20df2.

7.40 *DISTRIBUTING

Keyword type: model definition

With this keyword distributing constraints can be established between the nodes belonging to an element surface and a reference node. A distributing constraint specifies that a force or a moment in the reference node is distributed among the nodes belonging to the element surface. The weights are calculated from the area within the surface the reference node corresponds with.

The *DISTRIBUTING card must be immediately preceded by a *COUPLING keyword card, specifying the reference node and the element surface. If no ORIENTATION was specified on the *COUPLING card, the degrees of freedom apply to the global rectangular system, if an ORIENTATION was used, they apply to the local system. For a *DISTRIBUTING constraint the local system cannot be cylindrical.

The degrees of freedom to which the distributing constraint should apply, have to be specified underneath the *DISTRIBUTING card. They should belong to the range 1 to 6. Degrees of freedom 1 to 3 correspond to translations

along the local axes, if any, else the global axes are taken. Degrees of freedom 4 to 6 correspond to rotations about the local axes (4 about the local x-axis and so on), if any, else the global axes are taken. No matter what the user specifies, forces are always distributed (degree of freedom 1 to 3). Consequently, the only freedom the user has is to decide whether any additional moments should be distributed.

In the degrees of freedom in the reference node a force/moment can be applied by a *CLOAD card. This load system is replaced by an equivalent force distribution in the nodes belonging to the coupling surface. No matter what force and/or moment is applied to the reference node, all translational degrees of freedom of the nodes in the surface are updated. This means that for the first *CLOAD definition in the reference node in a step the parameter OP=NEW is de facto active.

No kinematic relations are created between the reference node and the coupling surface, so applying displacement constraints in the reference node has no effect. In fact, the displacements at the reference node remain zero throughout the calculation. In order to check the force and/or moment in the reference node the user should use *SECTION PRINT to obtain the global force and moment on the selected surface. To check the global displacements of the surface a *DISTRIBUTING COUPLING may be defined for the nodes in the surface. For the global rotations a mean rotation MPC (cf. Section 8.7.1) can be used.

Please note that it is not allowed to define transformations(*TRANSFORM) in the nodes belonging to a distributing coupling surface.

A *DISTRIBUTING coupling is usually selected in order to distribute a force or moment area-weighted among the nodes of a surface. For this to work properly the surface should be plane.

If any of these conditions is not satisfied, the results will be inaccurate.

There is one optional parameter: CYCLIC SYMMETRY. If it is active, the structure is assumed to be cyclic symmetric. In that case the reference node on the preceding *COUPLING keyword has to be on the cyclic symmetry axis. For cyclic symmetric structures only forces and moments aligned with the cyclic symmetry axis will be correctly redistributed.

First line:

- *DISTRIBUTING

Following line:

- first degree of freedom (only 1 to 6 allowed)
- last degree of freedom (only 1 to 6 allowed); if left blank the last degree of freedom coincides with the first degree of freedom.

Repeat this line if needed to constrain other degrees of freedom.

Example:

```

*ORIENTATION,NAME=OR1,SYSTEM=RECTANGULAR
0.,1.,0.,0.,0.,1.
*COUPLING,REF NODE=262,SURFACE=SURF,CONSTRAINT NAME=C1,ORIENTATION=OR1
*DISTRIBUTING
4,4
*NSET,NSET=N1
262
...
*STEP
*STATIC
*CLOAD
262,4,1.

```

specifies a moment of size 1. about the local x-axis, which happens to coincide with the global y-axis.

Example files: coupling7, cyl, coupling13, coupling 14.

7.41 *DISTRIBUTING COUPLING

Keyword type: model definition

This option is used to apply translational loading (force or displacement) on a set of nodes in a global sense (for rotations and/or moments the reader is referred to the mean rotation MPC, Section 8.7.1). There is one required parameter: ELSET. With the parameter ELSET an element set is referred to, which should contain exactly one element of type DCOUP3D. This type of element contains only one node, which is taken as the reference node of the distributing coupling. This node should not be used elsewhere in the model. In particular, it should not belong to any element. The coordinates of this node are immaterial. The distributing coupling forces or the distributing coupling displacements should be applied to the reference node with a *CLOAD card or a *BOUNDARY card, respectively.

Underneath the keyword card the user can enter the nodes on which the load is to be distributed, together with a weight. Internally, for each coordinate direction a multiple point constraint is generated between these nodes with the weights as coefficients. The last term in the equation is the reference node with as coefficient the negative of the sum of all weights. The more nodes are contained in the distributing coupling condition the longer the equation. This leads to a large, fully populated submatrix in the system of equations leading to long solution times. Therefore, it is recommended not to include more than maybe 50 nodes in a distributing coupling condition.

The first node underneath the keyword card is taken as dependent node in the MPC. Therefore, this node should not be repeated in any other MPC or at the first location in any other distributing coupling definition. It can be used as independent node in another distributing coupling (all but the first position), though, although certain limitations exist due to the mechanism by

which the MPC's are substituted into each other. Basically, not all dependent nodes in distributing couplings should be used as independent nodes as well. For example:

```
*DISTRIBUTING COUPLING,ELSET=E1
LOAD,1.
*DISTRIBUTING COUPLING,ELSET=E2
LOAD2,1.
*NSET,NSET=LOAD
5,6,7,8,22,25,28,31,100
*NSET,NSET=LOAD2
8,28,100,31
```

will work while

```
*DISTRIBUTING COUPLING,ELSET=E1
LOAD,1.
*DISTRIBUTING COUPLING,ELSET=E2
LOAD2,1.
*NSET,NSET=LOAD
5,6,7,8,22,25,28,31,100
*NSET,NSET=LOAD2
8,28,100,31,5
```

will not work because the dependent nodes 5 and 8 are used as independent nodes as well in EACH of the distributing coupling definitions. An error message will result in the form:

```
*ERROR in cascade: zero coefficient on the
dependent side of an equation
dependent node: 5
```

First line:

- *DISTRIBUTING COUPLING
- Enter the ELSET parameter and its value

Following line:

- Node number or node set
- Weight

Repeat this line if needed.

Example:

```
*DISTRIBUTING COUPLING,ELSET=E1
3,1.
100,1.
51,1.
428,1.
*ELSET,ELSET=E1
823
*ELEMENT,TYPE=DCOUP3D
823,4000
```

defines a distributing coupling between the nodes 3, 100, 51 and 428, each with weight 1. The reference node is node 4000. A point force of 10 in direction 1 can be applied to this distributing coupling by the cards:

```
*CLOAD
4000,1,10.
```

while a displacement of 0.5 is obtained with

```
*BOUNDARY
4000,1,1,0.5
```

Example files: distcoup.

7.42 *DISTRIBUTION

Keyword type: model definition

The *DISTRIBUTION keyword can be used to define elementwise local coordinate systems. In each line underneath the keyword the user lists an element number or element set and the coordinates of the points “a” and “b” describing the local system according to Figure 162 or 163 depending on whether the local system is rectangular or cylindrical. However, the first line underneath the *DISTRIBUTION keyword is reserved for the default local system and the element or element set entry should be left empty. There is one required parameter NAME specifying the name (maximum 80 characters) of the distribution.

Whether the local system is rectangular or cylindrical is determined by the *ORIENTATION card using the distribution. The local orientations defined underneath the *DISTRIBUTION card do not become active unless:

- the distribution is referred to by an *ORIENTATION card
- this *ORIENTATION card is used on a *SOLID SECTION card.

So far, a distribution can only be used in connection with a *SOLID SECTION card and not by any other SECTION cards (such as *SHELL SECTION, *BEAM SECTION etc.).

Two restrictions apply to the use of a distribution:

- an element should not be listed underneath more than one *DISTRIBUTION card
- a distribution cannot be used by more than one *ORIENTATION card.

First line:

- *DISTRIBUTION
- Enter the required parameter NAME.

Second line:

- empty
- X-coordinate of point a.
- Y-coordinate of point a.
- Z-coordinate of point a.
- X-coordinate of point b.
- Y-coordinate of point b.
- Z-coordinate of point b.

Following lines

- element label or element set label
- X-coordinate of point a.
- Y-coordinate of point a.
- Z-coordinate of point a.
- X-coordinate of point b.
- Y-coordinate of point b.
- Z-coordinate of point b.

Example:

```
*DISTRIBUTION,NAME=DI
,1.,0.,0.,0.,1.,0.
E1,0.,0.,1.,0.,1.,0.
```

defines a distribution with name DI. The default local orientation is defined by $a=(1,0,0)$ and $b=(0,1,0)$. The local orientation for the elements in set E1 is described by $a=(0,0,1)$ and $b(0,1,0)$.

Example files: beampo4.

7.43 *DLOAD

Keyword type: step

This option allows the specification of distributed loads. These include constant pressure loading on element faces, edge loading on shells and mass loading (load per unit mass) either by gravity forces or by centrifugal forces.

For surface loading the faces of the elements are numbered as follows (for the node numbering of the elements see Section 3.1):

for hexahedral elements:

- face 1: 1-2-3-4
- face 2: 5-8-7-6
- face 3: 1-5-6-2
- face 4: 2-6-7-3
- face 5: 3-7-8-4
- face 6: 4-8-5-1

for tetrahedral elements:

- Face 1: 1-2-3
- Face 2: 1-4-2
- Face 3: 2-4-3
- Face 4: 3-4-1

for wedge elements:

- Face 1: 1-2-3
- Face 2: 4-5-6
- Face 3: 1-2-5-4
- Face 4: 2-3-6-5
- Face 5: 3-1-4-6

for quadrilateral plane stress, plane strain and axisymmetric elements:

- Face 1: 1-2
- Face 2: 2-3
- Face 3: 3-4
- Face 4: 4-1

for triangular plane stress, plane strain and axisymmetric elements:

- Face 1: 1-2
- Face 2: 2-3
- Face 3: 3-1

for beam elements:

- Face 1: pressure in 1-direction
- Face 2: pressure in 2-direction

For shell elements no face number is needed since there is only one kind of loading: pressure in the direction of the normal on the shell.

The surface loading is entered as a uniform pressure with distributed load type label P_x where x is the number of the face. Thus, for pressure loading the magnitude of the load is positive, for tension loading it is negative. For nonuniform pressure the label takes the form $P_x N U y$, and the user subroutine `dload.f` must be provided. The label can be up to 20 characters long. In particular, y can be used to distinguish different nonuniform loading patterns (maximum 16 characters). A typical example of a nonuniform loading is the hydrostatic pressure. Another option is to assign the pressure of a fluid node to an element side. In that case the label takes the form $P_x N P$, where NP stands for network pressure. The fluid node must be an corner node of a network element. Instead of a concrete pressure value the user must provide the fluid node number.

Edge loading is only provided for shell elements. Its units are force per unit length. The label is $EDNOR_x$ where x can take a value between one and three for triangular shells and between one and four for quadrilateral shells. This type of loading is locally orthogonal to the edge. Internally, it is replaced by a pressure load, since shell elements in CalculiX are expanded into volumetric elements. The numbering is as follows:

for triangular shell elements:

- Edge 1: 1-2
- Edge 2: 2-3
- Edge 3: 3-1

for quadrilateral shell elements:

- Edge 1: 1-2
- Edge 2: 2-3
- Edge 3: 3-4
- Edge 4: 4-1

For centrifugal loading (label CENTRIF) the rotational speed square (ω^2) and two points on the rotation axis are required, for gravity loading with known gravity vector (label GRAV) the size and direction of the gravity vector are to be given. Whereas more than one centrifugal load for one and the same set is not allowed, several gravity loads can be defined, provided the direction of the load varies. If the gravity vector is not known it can be calculated based on the momentaneous mass distribution of the system (label NEWTON). This requires the value of the Newton gravity constant by means of a *PHYSICAL CONSTANTS card.

The limit of one centrifugal load per set does not apply to linear dynamic (*MODAL DYNAMIC) and steady state (*STEADY STATE DYNAMICS) calculations. Here, the limit is two. In this way a rotating eccentricity can be modeled. Prerequisite for the centrifugal loads to be interpreted as distinct is the choice of distinct rotation axes.

Optional parameters are OP, AMPLITUDE, TIME DELAY, LOAD CASE and SECTOR. OP takes the value NEW or MOD. OP=MOD is default. For surface loads it implies that the loads on different faces are kept from the previous step. Specifying a distributed load on a face for which such a load was defined in a previous step replaces this value, if a load was defined on the same face within the same step it is added. OP=NEW implies that all previous surface loading is removed. For mass loading the effect is similar. If multiple *DLOAD cards are present in a step this parameter takes effect for the first *DLOAD card only.

The AMPLITUDE parameter allows for the specification of an amplitude by which the force values are scaled (mainly used for dynamic calculations). Thus, in that case the values entered on the *DLOAD card are interpreted as reference values to be multiplied with the (time dependent) amplitude value to obtain the actual value. At the end of the step the reference value is replaced by the actual value at that time. In subsequent steps this value is kept constant unless it is explicitly redefined or the amplitude is defined using TIME=TOTAL TIME in which case the amplitude keeps its validity. For nonuniform loading the AMPLITUDE parameter has no effect.

The TIME DELAY parameter modifies the AMPLITUDE parameter. As such, TIME DELAY must be preceded by an AMPLITUDE name. TIME DELAY is a time shift by which the AMPLITUDE definition it refers to is moved in positive time direction. For instance, a TIME DELAY of 10 means that for time t the amplitude is taken which applies to time t-10. The TIME DELAY parameter must only appear once on one and the same keyword card.

The LOAD CASE parameter is only active in *STEADY STATE DYNAMICS calculations with harmonic loading. LOAD CASE = 1 means that the loading is real or in-phase. LOAD CASE = 2 indicates that the load is imaginary or equivalently phase-shifted by 90°. Default is LOAD CASE = 1.

The SECTOR parameter can only be used in *MODAL DYNAMIC and *STEADY STATE DYNAMICS calculations with cyclic symmetry. The datum sector (the sector which is modeled) is sector 1. The other sectors are numbered in increasing order in the rotational direction going from the slave surface to

the master surface as specified by the *TIE card. Consequently, the SECTOR parameters allows to apply a distributed load to any element face in any sector.

Notice that in case an element set is used on any line following *DLOAD this set should not contain elements from more than one of the following groups: {plane stress, plane strain, axisymmetric elements}, {beams, trusses}, {shells, membranes}, {volumetric elements}.

If more than one *DLOAD card occurs within the input deck, or a *DLOAD and at least one *DSLOAD card, the following rules apply:

If a *DLOAD or *DSLOAD with label P1 up to P6 or EDNOR1 up to EDNOR4 or BF is applied to an element for which a *DLOAD or *DSLOAD with the SAME label was already applied before, then

- if the previous application was in the same step the load value is added, else it is replaced
- the new amplitude (including none) overwrites the previous amplitude

If a *DLOAD with label CENTRIF is applied to the same set AND with the same rotation axis as in a previous application, then

- If the previous application was in the same step, the CENTRIF value is added, else it is replaced
- the new amplitude (including none) overwrites the previous amplitude

If a *DLOAD with label GRAV is applied to the same set AND with the same gravity direction vector as in a previous application, then

- If the previous application was in the same step, the GRAV value is added, else it is replaced
- the new amplitude (including none) overwrites the previous amplitude

First line:

- *DLOAD
- Enter any needed parameters and their value

Following line for surface loading:

- Element number or element set label.
- Distributed load type label.
- Actual magnitude of the load (for Px type labels) or fluid node number (for PxNU type labels)

Repeat this line if needed.

Example:

```
*DLOAD,AMPLITUDE=A1
Se1,P3,10.
```

assigns a pressure loading with magnitude 10. times the amplitude curve of amplitude A1 to face number three of all elements belonging to set Se1.

Example files: beamd.

Following line for centrifugal loading:

- Element number or element set label.
- CENTRIF
- rotational speed square (ω^2)
- Coordinate 1 of a point on the rotation axis
- Coordinate 2 of a point on the rotation axis
- Coordinate 3 of a point on the rotation axis
- Component 1 of the normalized direction of the rotation axis
- Component 2 of the normalized direction of the rotation axis
- Component 3 of the normalized direction of the rotation axis

Repeat this line if needed.

Example:

```
*DLOAD
Ea11,CENTRIF,100000.,0.,0.,0.,1.,0.,0.
```

Example files: achtelc, disk2.

assigns centrifugal loading with $\omega^2 = 100000.$ about an axis through the point (0.,0.,0.) and with direction (1.,0.,0.) to all elements.

Following line for gravity loading with known gravity vector:

- Element number or element set label.
- GRAV
- Actual magnitude of the gravity vector.
- Coordinate 1 of the normalized gravity vector

- Coordinate 2 of the normalized gravity vector
- Coordinate 3 of the normalized gravity vector

Repeat this line if needed. Here "gravity" really stands for any acceleration vector.

Example:

```
*DLOAD
Eall, GRAV, 9810., 0., 0., -1.
```

assigns gravity loading in the negative z-direction with magnitude 9810. to all elements.

Example files: achtelg, cube2.

Following line for gravity loading based on the momentaneous mass distribution:

- Element number or element set label.
- NEWTON

Repeat this line if needed. Only elements loaded by a NEWTON type loading are taken into account for the gravity calculation.

Example:

```
*DLOAD
Eall, NEWTON
```

triggers the calculation of gravity forces due to all mass belonging to the element of element set Eall.

Example files: cubenewt.

7.44 *DSLOAD

Keyword type: step

This option allows for (a) the specification of section stresses on the boundary of submodels, cf. the *SUBMODEL card and (b) the application of a pressure on a facial surface.

For submodels there are two required parameters: SUBMODEL and either STEP or DATA SET. Underneath the *DSLOAD card faces are listed for which a section stress will be calculated by interpolation from the global model. To this end these faces have to be part of a *SUBMODEL card, TYPE=SURFACE. The latter card also lists the name of the global model results file.

In case the global calculation was a *STATIC calculation the STEP parameter specifies the step in the global model which will be used for the interpolation. If results for more than one increment within the step are stored, the last increment is taken.

In case the global calculation was a *FREQUENCY calculation the DATA SET parameter specifies the mode in the global model which will be used for the interpolation. It is the number preceding the string MODAL in the .frd-file and it corresponds to the dataset number if viewing the .frd-file with CalculiX GraphiX. Notice that the global frequency calculation is not allowed to contain preloading nor cyclic symmetry.

The distributed load type label convention is the same as for the *DLOAD card. Notice that

- the section stresses are applied at once at the start of the step, no matter the kind of procedure the user has selected. For instance, the loads in a *STATIC procedure are usually ramped during the step. This is not the case of the section stresses.
- the section stresses are interpolated from the stress values at the nodes of the global model. These latter stresses have been extrapolated in the global model calculation from the stresses at the integration points. Therefore, the section stresses are not particularly accurate and generally the global equilibrium of the submodel will not be well fulfilled, resulting in stress concentrations near the nodes which are fixed in the submodel. Therefore, the use of section stresses is not recommended. A better procedure is the application of nodal forces (*CLOAD) at the intersection. These nodal forces may be obtained by performing a preliminary submodel calculation with displacement boundary conditions and requesting nodal force output.

For the application of a pressure on a facial surface there is one optional parameter AMPLITUDE specifying the name of the amplitude by which the pressure is to be multiplied (cf. *AMPLITUDE). The load label for pressure is P.

If more than one *DSLOAD card occurs in the input deck, or a *DLOAD and at least one *DSLOAD card, the rules explained underneath the keyword *DLOAD also apply here.

First line:

- *DSLOAD
- For submodels: enter the parameter SUBMODEL (no argument) and STEP with its argument

Following line for surface loading on submodels:

- Element number or element set label.
- Distributed load type label.

Repeat this line if needed.

Following line for pressure application on a surface:

- Surface name.
- Load label (the only available right now is P for pressure)
- Pressure.

Repeat this line if needed.

Example:

```
*DSLOAD, SUBMODEL, STEP=4
Se1, P3
```

specifies hat on face 3 of all elements belonging to set Se1 the section stress is to be determined by interpolation from step 4 in the global model.

Example files: .

7.45 *DYNAMIC

Keyword type: step

This procedure is used to calculate the response of a structure subject to dynamic loading using a direct integration procedure of the equations of motion.

There are five optional parameters: DIRECT, ALPHA, EXPLICIT, SOLVER and RELATIVE TO ABSOLUTE. The parameter DIRECT specifies that the user-defined initial time increment should not be changed. In case of no convergence with this increment size, the calculation stops with an error message. If this parameter is not set, the program will adapt the increment size depending on the rate of convergence. The parameter ALPHA takes an argument between -1/3 and 0. It controls the dissipation of the high frequency response: lower numbers lead to increased numerical damping ([62]). The default value is -0.05.

The parameter EXPLICIT can take the following values:

- 0: implicit structural computation, semi-implicit fluid computation
- 1: implicit structural computation, explicit fluid computation
- 2: explicit structural computation, semi-implicit fluid computation
- 3: explicit structural computation, explicit fluid computation

If the value is lacking, 3 is assumed. If the parameter is lacking altogether, a zero value is assumed.

The parameter SOLVER determines the package used to solve the ensuing system of equations. The following solvers can be selected:

- the SGI solver

- PaStiX
- PARDISO
- SPOOLES [3, 4].
- TAUCS
- the iterative solver by Rank and Ruecker [79], which is based on the algorithms by Schwarz [85].

Default is the first solver which has been installed of the following list: SGI, PaStiX, PARDISO, SPOOLES and TAUCS. If none is installed, the default is the iterative solver, which comes with the CalculiX package.

The SGI solver should by now be considered as outdated. SPOOLES is very fast, but has no out-of-core capability: the size of systems you can solve is limited by your RAM memory. With 32GB of RAM you can solve up to 1,000,000 equations. TAUCS is also good, but my experience is limited to the LL^T decomposition, which only applies to positive definite systems. It has an out-of-core capability and also offers a LU decomposition, however, I was not able to run either of them so far. PARDISO is the Intel proprietary solver and is about a factor of two faster than SPOOLES. The most recent solver we tried is the freeware solver PaStiX from INRIA. It is really fast and can use the GPU. For large problems and a high end Nvidia graphical card (32 GB of RAM) we got an acceleration of a factor between 3 and 8 compared to PARDISO. We modified PaStiX for this, therefore you have to download PaStiX from our website and compile it for your system. This can be slightly tricky, however, it is worth it!

What about the iterative solver? If `SOLVER=ITERATIVE SCALING` is selected, the pre-conditioning is limited to a scaling of the diagonal terms, `SOLVER=ITERATIVE CHOLESKY` triggers Incomplete Cholesky pre-conditioning. Cholesky pre-conditioning leads to a better convergence and maybe to shorter execution times, however, it requires additional storage roughly corresponding to the non-zeros in the matrix. If you are short of memory, diagonal scaling might be your last resort. The iterative methods perform well for truly three-dimensional structures. For instance, calculations for a hemisphere were about nine times faster with the `ITERATIVE SCALING` solver, and three times faster with the `ITERATIVE CHOLESKY` solver than with SPOOLES. For two-dimensional structures such as plates or shells, the performance might break down drastically and convergence often requires the use of Cholesky pre-conditioning. SPOOLES (and any of the other direct solvers) performs well in most situations with emphasis on slender structures but requires much more storage than the iterative solver.

Finally, the parameter `RELATIVE TO ABSOLUTE` can be used if the coordinate system in the previous step was attached to a rotating system and the coordinate system in the present dynamic step should be absolute. In that case, the velocity of the rotating system is added to the relative velocity obtained at the end of the previous step in all nodes belonging to elements in which centrifugal loading was defined. Thereafter, the centrifugal loading is deactivated.

For instance, suppose that you start a calculation with a *STATIC step with a centrifugal load, i.e. all quantities are determined in the relative, rotating system. In a subsequent dynamic step you want to continue the calculation in the absolute system. In that case you need the parameter RELATIVE TO ABSOLUTE.

In a dynamic step, loads are by default applied by their full strength at the start of the step. Other loading patterns can be defined by an *AMPLITUDE card.

First line:

- *DYNAMIC
- enter any parameters and their values, if needed.

Second line:

- Initial time increment. This value will be modified due to automatic incrementation, unless the parameter DIRECT was specified.
- Time period of the step.
- Minimum time increment allowed. Only active if DIRECT is not specified. Default is the initial time increment or 1.e-10 times the time period of the step, whichever is smaller.
- Maximum time increment allowed. Only active if DIRECT is not specified. Default is 1.e+30.
- Initial time increment for CFD applications (default 1.e-2)

Examples:

```
*DYNAMIC,DIRECT,EXPLICIT
1.E-7,1.E-5
```

defines an explicit dynamic procedure with fixed time increment 10^{-7} for a step of length 10^{-5} .

```
*DYNAMIC,ALPHA=-0.3,SOLVER=ITERATIVE CHOLESKY
1.E-7,1.E-5,1.E-9,1.E-6
```

defines an implicit dynamic procedure with variable increment size. The numerical damping was increased ($\alpha = -0.3$ instead of the default $\alpha = -0.05$, and the iterative solver with Cholesky pre-conditioning was selected. The starting increment has a size 10^{-7} , the subsequent increments should not have a size smaller than 10^{-9} or bigger than 10^{-6} . The step size is 10^{-5} .

Example files: beamnldy, beamnldye, beamnldyp, beamnldype.

7.46 *ELASTIC

Keyword type: model definition, material

This option is used to define the elastic properties of a material. There is one optional parameter TYPE. Default is TYPE=ISO, other values are TYPE=ORTHO and TYPE=ENGINEERING CONSTANTS for orthotropic materials and TYPE=ANISO for anisotropic materials. All constants may be temperature dependent. For orthotropic and fully anisotropic materials, the coefficients D_{IJKL} satisfy the equation:

$$S_{IJ} = D_{IJKL}E_{KL}, \quad I, J, K, L = 1..3 \quad (857)$$

where S_{IJ} is the second Piola-Kirchhoff stress and E_{KL} is the Lagrange deformation tensor (nine terms on the right hand side for each equation). For linear calculations, these reduce to the generic stress and strain tensors.

An isotropic material can be defined as an anisotropic material by defining $D_{1111} = D_{2222} = D_{3333} = \lambda + 2\mu$, $D_{1122} = D_{1133} = D_{2233} = \lambda$ and $D_{1212} = D_{1313} = D_{2323} = \mu$, where λ and μ are the Lamé constants [23].

First line:

- *ELASTIC
- Enter the TYPE parameter and its value, if needed

Following line for TYPE=ISO:

- Young's modulus.
- Poisson's ratio.
- Temperature.

Repeat this line if needed to define complete temperature dependence.

Following lines, in a pair, for TYPE=ORTHO: First line of pair:

- D_{1111} .
- D_{1122} .
- D_{2222} .
- D_{1133} .
- D_{2233} .
- D_{3333} .
- D_{1212} .
- D_{1313} .

Second line of pair:

- D_{2323} .
- Temperature.

Repeat this pair if needed to define complete temperature dependence.

Following lines, in a pair, for TYPE=ENGINEERING CONSTANTS: First line of pair:

- E_1 .
- E_2 .
- E_3 .
- ν_{12} .
- ν_{13} .
- ν_{23} .
- G_{12} .
- G_{13} .

Second line of pair:

- G_{23} .
- Temperature.

Repeat this pair if needed to define complete temperature dependence.

Following lines, in sets of 3, for TYPE=ANISO: First line of set:

- D_{1111} .
- D_{1122} .
- D_{2222} .
- D_{1133} .
- D_{2233} .
- D_{3333} .
- D_{1112} .
- D_{2212} .

Second line of set:

- D_{3312} .
- D_{1212} .
- D_{1113} .
- D_{2213} .
- D_{3313} .
- D_{1213} .
- D_{1313} .
- D_{1123} .

Third line of set:

- D_{2223} .
- D_{3323} .
- D_{1223} .
- D_{1323} .
- D_{2323} .
- Temperature.

Repeat this set if needed to define complete temperature dependence.

Example:

```
*ELASTIC,TYPE=ORTHO
500000.,157200.,400000.,157200.,157200.,300000.,126200.,126200.,
126200.,294.
```

defines an orthotropic material for temperature T=294. Since the definition includes values for only one temperature, they are valid for all temperatures.

Example files: aniso, beampol.

7.47 *ELECTRICAL CONDUCTIVITY

Keyword type: model definition, material

This option is used to define the electrical conductivity of a material. There are no parameters. The material is supposed to be isotropic. The constant may be temperature dependent. The unit of the electrical conductivity coefficient is one divided by the unit of resistivity (in SI-units: ohm) times the unit of length.

First line:

- *ELECTRICAL CONDUCTIVITY

Following line:

- σ .
- Temperature.

Repeat this line if needed to define complete temperature dependence.

Example:

```
*ELECTRICAL CONDUCTIVITY
5.96E7
```

tells you that the electrical conductivity coefficient is 5.96E7, independent of temperature (if SI-units are used this is the electrical conductivity of copper).

Example files: induction.

7.48 *ELECTROMAGNETICS

Keyword type: step

This procedure is used to perform a electromagnetic analysis. If transient, it may be combined with a heat analysis. In that case the calculation is nonlinear since the material properties depend on the solution, i.e. the temperature.

There are nine optional parameters: SOLVER, DIRECT, MAGNETOSTATICS, DELTMX, TIME RESET and TOTAL TIME AT START, NO HEAT TRANSFER, FREQUENCY and OMEGA.

SOLVER determines the package used to solve the ensuing system of equations. The following solvers can be selected:

- the SGI solver
- PaStiX
- PARDISO
- SPOOLES [3, 4].
- TAUCS
- the iterative solver by Rank and Ruecker [79], which is based on the algorithms by Schwarz [85].

Default is the first solver which has been installed of the following list: SGI, PaStiX, PARDISO, SPOOLES and TAUCS. If none is installed, the default is the iterative solver, which comes with the CalculiX package.

The SGI solver should by now be considered as outdated. SPOOLES is very fast, but has no out-of-core capability: the size of systems you can solve is limited by your RAM memory. With 32GB of RAM you can solve up to 1,000,000

equations. TAUCS is also good, but my experience is limited to the LL^T decomposition, which only applies to positive definite systems. It has an out-of-core capability and also offers a LU decomposition, however, I was not able to run either of them so far. PARDISO is the Intel proprietary solver and is about a factor of two faster than SPOOLES. The most recent solver we tried is the freeware solver PaStiX from INRIA. It is really fast and can use the GPU. For large problems and a high end Nvidia graphical card (32 GB of RAM) we got an acceleration of a factor between 3 and 8 compared to PARDISO. We modified PaStiX for this, therefore you have to download PaStiX from our website and compile it for your system. This can be slightly tricky, however, it is worth it!

What about the iterative solver? If SOLVER=ITERATIVE SCALING is selected, the pre-conditioning is limited to a scaling of the diagonal terms, SOLVER=ITERATIVE CHOLESKY triggers Incomplete Cholesky pre-conditioning. Cholesky pre-conditioning leads to a better convergence and maybe to shorter execution times, however, it requires additional storage roughly corresponding to the non-zeros in the matrix. If you are short of memory, diagonal scaling might be your last resort. The iterative methods perform well for truly three-dimensional structures. For instance, calculations for a hemisphere were about nine times faster with the ITERATIVE SCALING solver, and three times faster with the ITERATIVE CHOLESKY solver than with SPOOLES. For two-dimensional structures such as plates or shells, the performance might break down drastically and convergence often requires the use of Cholesky pre-conditioning. SPOOLES (and any of the other direct solvers) performs well in most situations with emphasis on slender structures but requires much more storage than the iterative solver.

The parameter DIRECT indicates that automatic incrementation should be switched off. The increments will have the fixed length specified by the user on the second line.

The parameter MAGNETOSTATICS indicates that only the steady state should be calculated. Since the magnetic field does not change, no heat is produced and a heat transfer analysis does not make sense. The loading (coil current in the shell elements) is applied by its full strength. If the MAGNETOSTATICS parameter is absent, the calculation is assumed to be time dependent and a transient analysis is performed. A transient analysis triggers by default a complementary heat transfer analysis, thus the temperature dependence of the properties of the materials involved must be provided. Here too, the coil currents are by default applied by their full strength at the start of the step. Other loading patterns can be defined by an *AMPLITUDE card.

The parameter DELTMX can be used to limit the temperature change in two subsequent increments. If the temperature change exceeds DELTMX the increment is restarted with a size equal to D_A times DELTMX divided by the temperature change. The default for D_A is 0.85, however, it can be changed by the *CONTROLS keyword. DELTMX is only active in transient calculations. Default value is 10^{30} .

The parameter TIME RESET can be used to force the total time at the end of the present step to coincide with the total time at the end of the previous step.

If there is no previous step the targeted total time is zero. If this parameter is absent the total time at the end of the present step is the total time at the end of the previous step plus the time period of the present step (2nd parameter underneath the *HEAT TRANSFER keyword). Consequently, if the time at the end of the previous step is 10. and the present time period is 1., the total time at the end of the present step is 11. If the TIME RESET parameter is used, the total time at the beginning of the present step is 9. and at the end of the present step it will be 10. This is sometimes useful if transient heat transfer calculations are preceded by a stationary heat transfer step to reach steady state conditions at the start of the transient heat transfer calculations. Using the TIME RESET parameter in the stationary step (the first step in the calculation) will lead to a zero total time at the start of the subsequent instationary step.

The parameter TOTAL TIME AT START can be used to set the total time at the start of the step to a specific value.

Next, the parameter NO HEAT TRANSFER may be used in a transient analysis to indicate that no heat generated by the Eddy currents should be calculated. However, an external temperature field may be defined using the *TEMPERATURE card.

Finally, the parameters FREQUENCY and OMEGA are used to obtain the steady state answer of the electromagnetic fields due to an alternating current. OMEGA is the frequency of the current. The answer consists of a real part (stored first) and an imaginary part (stored last) of the electric and magnetic field.

First line:

- *ELECTROMAGNETICS
- Enter any needed parameters and their values.

Second line:

- Initial time increment. This value will be modified due to automatic incrementation, unless the parameter DIRECT was specified (default 1.).
- Time period of the step (default 1.).
- Minimum time increment allowed. Only active if DIRECT is not specified. Default is the initial time increment or 1.e-5 times the time period of the step, whichever is smaller.
- Maximum time increment allowed. Only active if DIRECT is not specified. Default is 1.e+30.

Example:

```
*ELECTROMAGNETICS,DIRECT
.1,1.
```

defines a static step and selects the SPOOLES solver as linear equation solver in the step (default). The second line indicates that the initial time increment is .1 and the total step time is 1. Furthermore, the parameter DIRECT leads to a fixed time increment. Thus, if successful, the calculation consists of 10 increments of length 0.1.

Example files: induction, induction2, induction3.

7.49 *ELEMENT

Keyword type: model definition

With this option elements are defined. There is one required parameter, TYPE and one optional parameter, ELSET. The parameter TYPE defines the kind of element which is being defined. The following types can be selected:

- General 3D solids
 - C3D4 (4-node linear tetrahedral element)
 - C3D6 (6-node linear triangular prism element)
 - C3D8 (3D 8-node linear hexahedral element)
 - C3D8I (3D 8-node linear hexahedral element with incompatible modes)
 - C3D8R (the C3D8 element with reduced integration)
 - C3D10 (10-node quadratic tetrahedral element)
 - C3D10T (10-node quadratic tetrahedral element with linearly interpolated initial temperatures)
 - C3D15 (15-node quadratic triangular prism element)
 - C3D20 (3D 20-node quadratic hexahedral element)
 - C3D20R (the C3D20 element with reduced integration)
- General CFD fluid elements
 - F3D4 (4-node linear tetrahedral element)
 - F3D6 (6-node linear triangular prism element)
 - F3D8 (8-node linear hexahedral element)
- “ABAQUS” 3D solids for heat transfer (names are provided for compatibility)
 - DC3D4: identical to C3D4
 - DC3D6: identical to C3D6
 - DC3D8: identical to C3D8
 - DC3D10: identical to C3D10
 - DC3D15: identical to C3D15

- DC3D20: identical to C3D20
- Shell elements
 - S3 (3-node triangular shell element)
 - S4 (4-node quadratic shell element)
 - S4R (the S4 element with reduced integration)
 - S6 (6-node triangular shell element)
 - S8 (8-node quadratic shell element)
 - S8R (the S8 element with reduced integration)
 - Membrane elements
 - M3D3 (3-node triangular membrane element)
 - M3D4 (4-node quadratic membrane element)
 - M3D4R (the S4 element with reduced integration)
 - M3D6 (6-node triangular membrane element)
 - M3D8 (8-node quadratic membrane element)
 - M3D8R (the S8 element with reduced integration)
- Plane stress elements
 - CPS3 (3-node triangular plane stress element)
 - CPS4 (4-node quadratic plane stress element)
 - CPS4R (the CPS4 element with reduced integration)
 - CPS6 (6-node triangular plane stress element)
 - CPS8 (8-node quadratic plane stress element)
 - CPS8R (the CPS8 element with reduced integration)
- Plane strain elements
 - CPE3 (3-node triangular plane strain element)
 - CPE4 (4-node quadratic plane strain element)
 - CPE4R (the CPE4 element with reduced integration)
 - CPE6 (6-node triangular plane strain element)
 - CPE8 (8-node quadratic plane strain element)
 - CPE8R (the CPS8 element with reduced integration)
- Axisymmetric elements
 - CAX3 (3-node triangular axisymmetric element)
 - CAX4 (4-node quadratic axisymmetric element)

- CAX4R (the CAX4 element with reduced integration)
- CAX6 (6-node triangular axisymmetric element)
- CAX8 (8-node quadratic axisymmetric element)
- CAX8R (the CAX8 element with reduced integration)
- Beam elements
 - B21 (2-node 2D beam element)
 - B31 (2-node 3D beam element)
 - B31R (the B31 element with reduced integration)
 - B32 (3-node beam element)
 - B32R (the B32 element with reduced integration)
- Truss elements
 - T2D2 (2-node 2D truss element)
 - T3D2 (2-node 3D truss element)
 - T3D3 (3-node 3D truss element)
- Special elements
 - D (3-node network element)
 - GAPUNI (2-node unidirectional gap element)
 - DASHPOTA (2-node 3D dashpot)
 - SPRING1 (1-node 3D spring)
 - SPRING2 (2-node 3D spring with fixed direction of action)
 - SPRINGA (2-node 3D spring with solution-dependent direction of action)
 - DCOUP3D (distributing coupling element)
 - MASS (mass element)
 - Uxxxx (user element)

Notice that the S8, S8R, CPS8, CPS8R, CPE8, CPE8R, CAX8, CAX8R, B32 and B32R element are internally expanded into 20-node brick elements. Please have a look at Section 6.2 for details and decision criteria which element to take. The element choice determines to a large extent the quality of the results. Do not take element choice lightheartedly! The parameter ELSET is used to assign the elements to an element set. If the set already exists, the elements are ADDED to the set.

First line:

- *ELEMENT

- Enter any needed parameters and their values.

Following line:

- Element number.
- Node numbers forming the element. The order of nodes around the element is given in section 2.1. Use continuation lines for elements having more than 15 nodes (maximum 16 entries per line).

Repeat this line if needed.

Example:

```
*ELEMENT,ELSET=Ea11,TYPE=C3D20R
1,1,2,3,4,5,6,7,8,9,10,11,12,13,14,15,
16,17,18,19,20
```

defines one 20-node element with reduced integration and stores it in set Ea11.

Example files: beam8p, beam10p, beam20p.

7.50 *ELEMENT OUTPUT

Keyword type: step

This option is used to save selected element variables averaged at the nodal points in a .frd file (extension .frd) for subsequent viewing by CalculiX GraphiX. The options and its use are identical with the *EL FILE keyword, however, the resulting .frd file is a mixture of binary and ASCII (the .frd file generated by using *EL FILE is completely ASCII). This has the advantage that the file is smaller and can be faster read by cgx.

If FILE and OUTPUT cards are mixed within one and the same step the last such card will determine whether the .frd file is completely in ASCII or a mixture of binary and ASCII.

Example:

```
*ELEMENT OUTPUT
S,PEEQ
```

requests that the (Cauchy) stresses and the equivalent plastic strain is stored in .frd format for subsequent viewing with CalculiX GraphiX.

Example files: cubespring.

7.51 *EL FILE

Keyword type: step

This option is used to save selected element variables averaged at the nodal points in a frd file (extension .frd) for subsequent viewing by CalculiX GraphiX. The following element variables can be selected (the label in square brackets [] is the one used in the .frd file; for frequency calculations with cyclic symmetry both a real and an imaginary part may be stored, in all other cases only the real part is stored):

- CEEQ [PE]: equivalent creep strain (is converted internally into PEEQ since the viscoplastic theory does not distinguish between the two; consequently, the user will find PEEQ in the frd file, not CEEQ)
- E [TOSTRAIN (real),TOSTRAII (imaginary)]: strain. This is the total Lagrangian strain for (hyper)elastic materials and incremental plasticity and the total Eulerian strain for deformation plasticity.
- ECD [CURR]: electrical current density. This only applies to electromagnetic calculations.
- EMFB [EMFB]: Magnetic field. This only applies to electromagnetic calculations.
- EMFE [EMFE]: Electric field. This only applies to electromagnetic calculations.
- ENER [ENER]: the energy density.
- ERR [ERROR (real), ERRORI (imaginary)]: error estimator for structural calculations (cf. Section 6.12). Notice that ERR and ZZS are mutually exclusive.
- HER [HERROR (real), HERRORI (imaginary)]: error estimator for heat transfer calculations(cf. Section 6.12).
- HFL [FLUX]: heat flux in structures.
- HFLF [FLUX]: heat flux in CFD-calculations.
- MAXE [MSTRAIN]: maximum of the absolute value of the worst principal strain at all times for *FREQUENCY calculations with cyclic symmetry. It is stored for nodes belonging to the node set with name STRAINDOMAIN. This node set must have been defined by the user with the *NSET command. The worst principal strain is the maximum of the absolute value of the principal strains times its original sign.
- MAXS [MSTRESS]: maximum of the absolute value of the worst principal stress at all times for *FREQUENCY calculations with cyclic symmetry. It is stored for nodes belonging to the node set with name STRESSDOMAIN. This node set must have been defined by the user with the *NSET

command. The worst principal stress is the maximum of the absolute value of the principal stresses times its original sign.

- ME [MESTRAIN (real), MESTRAII (imaginary)]: strain. This is the mechanical Lagrangian strain for (hyper)elastic materials and incremental plasticity and the mechanical Eulerian strain for deformation plasticity (mechanical strain = total strain - thermal strain).
- PEEQ [PE]: equivalent plastic strain.
- PHS [PSTRESS]: stress: magnitude and phase (only for *STEADY STATE DYNAMICS calculations and *FREQUENCY calculations with cyclic symmetry).
- S [STRESS (real), STRESSI (imaginary)]: true (Cauchy) stress in structures. For beam elements this tensor is replaced by the section forces if SECTION FORCES is selected. Selection of S automatically triggers output of the error estimator ERR, unless NOE is selected after S (either immediately following S, or with some other output requests in between, irrespective whether these output requests are on the same keyword card or on different keyword cards).
- SF [STRESS]: total stress in CFD-calculations.
- SMID [STRMID]: true (Cauchy) stress at the midsurface of a shell. This can only be used for shell elements which have been defined as user elements. It cannot be used of shell elements the label of which starts with S, since these are expanded into volumetric elements.
- SNEG [STRNEG]: true (Cauchy) stress at the negative surface of a shell. This can only be used for shell elements which have been defined as user elements. It cannot be used of shell elements the label of which starts with S, since these are expanded into volumetric elements.
- SPOS [STRPOS]: true (Cauchy) stress at the positive surface of a shell. This can only be used for shell elements which have been defined as user elements. It cannot be used of shell elements the label of which starts with S, since these are expanded into volumetric elements.
- SVF [VSTRES]: viscous stress in CFD-calculations.
- SDV [SDV]: the internal state variables.
- THE [THSTRAIN]: strain. This is the thermal strain calculated by subtracting the mechanical strain (extrapolated to the nodes) from the total strain (extrapolated to the nodes) at the nodes. Selection of THE triggers the selection of E and ME. This is needed to ensure that E (the total strain) and ME (the mechanical strain) are extrapolated to the nodes.
- ZZS [ZZSTR (real), ZZSTRI (imaginary)]: Zienkiewicz-Zhu improved stress [111], [112](cf. Section 6.12). Notice that ZZS and ERR are mutually exclusive.

The selected variables are stored for the complete model. Due to the averaging process jumps at material interfaces are smeared out unless you model the materials on both sides of the interface independently and connect the coinciding nodes with MPC's.

For frequency calculations with cyclic symmetry the eigenmodes are generated in pairs (different by a phase shift of 90 degrees). Only the first one of each pair is stored in the frd file. If S is selected (the stresses) two load cases are stored in the frd file: a loadcase labeled STRESS containing the real part of the stresses and a loadcase labeled STRESSI containing the imaginary part of the stresses. For all other variables only the real part is stored.

The key ENER triggers the calculation of the internal energy. If it is absent no internal energy is calculated. Since in nonlinear calculations the internal energy at any time depends on the accumulated energy at all previous times, the selection of ENER in nonlinear calculations (geometric or material nonlinearities) must be made in the first step.

The first occurrence of an *EL FILE keyword card within a step wipes out all previous element variable selections for file output. If no *EL FILE card is used within a step the selections of the previous step apply. If there is no previous step, no element variables will be stored.

There are ten optional parameters: FREQUENCY, FREQUENCYF, GLOBAL, OUTPUT, OUTPUT ALL, SECTION FORCES, TIME POINTS, NSET, LAST ITERATIONS and CONTACT ELEMENTS. The parameters FREQUENCY and TIME POINTS are mutually exclusive.

FREQUENCY applies to nonlinear calculations where a step can consist of several increments. Default is FREQUENCY=1, which indicates that the results of all increments will be stored. FREQUENCY=N with N an integer indicates that the results of every Nth increment will be stored. The final results of a step are always stored. If you only want the final results, choose N very big. The value of N applies to *OUTPUT, *ELEMENT OUTPUT, *EL FILE, *ELPRINT, *NODE OUTPUT, *NODE FILE, *NODE PRINT, *SECTION PRINT, *CONTACT OUTPUT, *CONTACT FILE and *CONTACT PRINT. If the FREQUENCY parameter is used for more than one of these keywords with conflicting values of N, the last value applies to all. A frequency parameter stays active across several steps until it is overwritten by another FREQUENCY value or the TIME POINTS parameter.

The 3D fluid analogue of FREQUENCY is FREQUENCYF. In coupled calculations FREQUENCY applies to the thermomechanical output, FREQUENCYF to the 3D fluid output.

With the parameter GLOBAL you tell the program whether you would like the results in the global rectangular coordinate system or in the local element system. If an *ORIENTATION card is applied to the element at stake, this card defines the local system. If no *ORIENTATION card is applied to the element, the local system coincides with the global rectangular system unless for shell elements, for which a local system is automatically defined by default (cf. Section 6.2.14). Default value for the GLOBAL parameter is GLOBAL=YES, which means that the results are stored in the global system (the only exception

to this is for the shell stresses SNEG, SMID and SPOS, which are always stored in the shell local system). If you prefer the results in the local system, specify GLOBAL=NO.

The parameter OUTPUT can take the value 2D or 3D. This has only effect for 1d and 2d elements such as beams, shells, plane stress, plane strain and axisymmetric elements AND provided it is used in the first step. If OUTPUT=3D, the 1d and 2d elements are stored in their expanded three-dimensional form. In particular, the user has the advantage to see his/her 1d/2d elements with their real thickness dimensions. However, the node numbers are new and do not relate to the node numbers in the input deck. Once selected, this parameter is active in the complete calculation. If OUTPUT=2D the fields in the expanded elements are averaged to obtain the values in the nodes of the original 1d and 2d elements. In particular, averaging removes the bending stresses in beams and shells. Therefore, default for beams and shells is OUTPUT=3D, for plane stress, plane strain and axisymmetric elements it is OUTPUT=2D. If OUTPUT=3D is selected, the parameter NSET is deactivated.

The parameter OUTPUT ALL specifies that the data has to be stored for all nodes, including those belonging to elements which have been deactivated. Default is storage for nodes belonging to active elements only.

The selection of SECTION FORCES makes sense for beam elements only. Furthermore, SECTION FORCES and OUTPUT=3D are mutually exclusive (if both are used the last prevails). If selected, the stresses in the beam nodes are replaced by the section forces. They are calculated in a local coordinate system consisting of the 1-direction \mathbf{n}_1 , the 2-direction \mathbf{n}_2 and 3-direction or tangential direction \mathbf{t} (Figure 74). Accordingly, the stress components now have the following meaning:

- xx: Shear force in 1-direction
- yy: Shear force in 2-direction
- zz: Normal force
- xy: Torque
- xz: Bending moment about the 2-direction
- yz: Bending moment about the 1-direction

For all elements except the beam elements the parameter SECTION FORCES has no effect. If SECTION FORCES is not selected the stress tensor is averaged across the beam section.

With the parameter TIME POINTS a time point sequence can be referenced, defined by a *TIME POINTS keyword. In that case, output will be provided for all time points of the sequence within the step and additionally at the end of the step. No other output will be stored and the FREQUENCY parameter is not taken into account. Within a step only one time point sequence can be active. If more than one is specified, the last one defined on any of the keyword cards

*NODE FILE, *EL FILE, *NODE PRINT or *EL PRINT will be active. The TIME POINTS option should not be used together with the DIRECT option on the procedure card. The TIME POINTS parameters stays active across several steps until it is replaced by another TIME POINTS value or the FREQUENCY parameter.

The specification of a node set with the parameter NSET limits the output to the nodes contained in the set. Remember that the frd file is node based, so element results are also stored at the nodes after extrapolation from the integration points. For cyclic symmetric structures the usage of the parameter NGRAPH on the *CYCLIC SYMMETRY MODEL card leads to output of the results not only for the node set specified by the user (which naturally belongs to the base sector) but also for all corresponding nodes of the sectors generated by the NGRAPH parameter. Notice that for cyclic symmetric structures in modal dynamic and steady state dynamics calculations the use of NSET is mandatory. In that case the stresses will only be correct at those nodes belonging to elements for which ALL nodal displacements were requested (e.g. by a *NODE FILE card).

The parameter LAST ITERATIONS leads to the storage of the displacements in all iterations of the last increment in a file with name ResultsForLastIterations.frd (can be opened with CalculiX GraphiX). This is useful for debugging purposes in case of divergence. No such file is created if this parameter is absent.

Finally, the parameter CONTACT ELEMENTS stores the contact elements which have been generated in each iteration in a file with the name jobname.cel. When opening the frd file with CalculiX GraphiX these files can be read with the command “read jobname.cel inp” and visualized by plotting the elements in the sets contactelements_st α _in β _at γ _it δ , where α is the step number, β the increment number, γ the attempt number and δ the iteration number.

Starting with version 2.14 of CalculiX the selection of “S” (stress) automatically triggers the output the stress error estimator “ERR” as well. This can only be avoided by selecting NOE in a position after S (either immediately following S, or with some other output requests in between, irrespective whether these output requests are on the same keyword card or on different keyword cards).

First line:

- *EL FILE
- Enter any needed parameters and their values.

Second line:

- Identifying keys for the variables to be printed, separated by commas.

Example:

```
*EL FILE
S,PEEQ
```

requests that the (Cauchy) stresses and the equivalent plastic strain is stored in .frd format for subsequent viewing with CalculiX GraphiX.

Example files: beamt, fullseg, segment1, segdyn.

7.52 *EL PRINT

Keyword type: step

This option is used to print selected element variables in an ASCII file with the name jobname.dat. Some of the element variables are printed in the integration points, some are whole element variables. The following variables can be selected:

- Integration point variables
 - true (Cauchy) stress in structures (key=S).
 - viscous stress in CFD calculations (key=SVF).
 - strain (key=E). This is the total Lagrangian strain for (hyper)elastic materials and incremental plasticity and the total Eulerian strain for deformation plasticity.
 - strain (key=ME). This is the mechanical Lagrangian strain for (hyper)elastic materials and incremental plasticity and the mechanical Eulerian strain for deformation plasticity (mechanical strain = total strain - thermal strain).
 - equivalent plastic strain (key=PEEQ)
 - equivalent creep strain (key=CEEQ; is converted internally into PEEQ since the viscoplastic theory does not distinguish between the two; consequently, the user will find PEEQ in the dat file, not CEEQ)
 - the energy density (key=ENER)
 - the internal state variables (key=SDV)
 - heat flux for structures (key=HFL).
 - heat flux in CFD calculations(key=HFLF).
 - global coordinates (key=COORD).
- Whole element variables
 - the internal energy (key=ELSE)
 - the kinetic energy (key=ELKE)
 - the volume (key=EVOL)
 - the mass and the mass moments of inertia about the global axes I_{xx} , I_{yy} , I_{zz} , I_{xy} , I_{xz} and I_{yz} , where

$$I_{xx} = \int_{V_0} x^2 dm \quad (858)$$

and similar for the other expressions. If TOTALS=YES or TOTALS=ONLY is selected the center of gravity and the mass moments of inertia about the global axes through the center of gravity are calculated too (key=EMAS).

- the heating power (key=EBHE)
- the rotational speed square (ω^2) (key=CENT)

The keys ENER and ELSE trigger the calculation of the internal energy. If they are absent no internal energy is calculated. Since in nonlinear calculations the internal energy at any time depends on the accumulated energy at all previous times, the selection of ENER and/or ELSE in nonlinear calculations (geometric or material nonlinearities) must be made in the first step.

There are six parameters, ELSET, FREQUENCY, FREQUENCYF, TOTALS, GLOBAL and TIME POINTS. The parameter ELSET is required, defining the set of elements for which these stresses should be printed. If this card is omitted, no values are printed. Several *EL PRINT cards can be used within one and the same step.

The parameters FREQUENCY and TIME POINTS are mutually exclusive.

The FREQUENCY parameter is optional and applies to nonlinear calculations where a step can consist of several increments. Default is FREQUENCY=1, which indicates that the results of all increments will be stored. FREQUENCY=N with N an integer indicates that the results of every Nth increment will be stored. The final results of a step are always stored. If you only want the final results, choose N very big. The value of N applies to *OUTPUT, *ELEMENT OUTPUT, *EL FILE, *ELPRINT, *NODE OUTPUT, *NODE FILE, *NODE PRINT, *SECTION PRINT, *CONTACT OUTPUT, *CONTACT FILE and *CONTACT PRINT. If the FREQUENCY parameter is used for more than one of these keywords with conflicting values of N, the last value applies to all. A frequency parameter stays active across several steps until it is overwritten by another FREQUENCY value or the TIME POINTS parameter.

The 3D fluid analogue of FREQUENCY is FREQUENCYF. In coupled calculations FREQUENCY applies to the thermomechanical output, FREQUENCYF to the 3D fluid output.

The optional parameter TOTALS only applies to whole element variables. If TOTALS=YES the sum of the variables for the whole element set is printed in addition to their value for each element in the set separately. If TOTALS=ONLY is selected the sum is printed but the individual element contributions are not. If TOTALS=NO (default) the individual contributions are printed, but their sum is not.

With the parameter GLOBAL (optional) you tell the program whether you would like the results in the global rectangular coordinate system or in the local element system. If an *ORIENTATION card is applied to the element at stake, this card defines the local system. If no *ORIENTATION card is applied to the element, the local system coincides with the global rectangular system. Default value for the GLOBAL parameter is GLOBAL=NO, which means that

the results are stored in the local system. If you prefer the results in the global system, specify GLOBAL=YES. If the results are stored in the local system the first 10 characters of the name of the applicable orientation are listed at the end of the line.

With the parameter TIME POINTS a time point sequence can be referenced, defined by a *TIME POINTS keyword. In that case, output will be provided for all time points of the sequence within the step and additionally at the end of the step. No other output will be stored and the FREQUENCY parameter is not taken into account. Within a step only one time point sequence can be active. If more than one is specified, the last one defined on any of the keyword cards *NODE FILE, *EL FILE, *NODE PRINT, *EL PRINT or *SECTION PRINT will be active. The TIME POINTS option should not be used together with the DIRECT option on the procedure card. The TIME POINTS parameters stays active across several steps until it is replaced by another TIME POINTS value or the FREQUENCY parameter.

The first occurrence of an *EL FILE keyword card within a step wipes out all previous element variable selections for print output. If no *EL FILE card is used within a step the selections of the previous step apply, if any.

First line:

- *EL PRINT
- Enter the parameter ELSET and its value.

Second line:

- Identifying keys for the variables to be printed, separated by commas.

Example:

```
*EL PRINT,ELSET=Copper
E
```

requests to store the strains at the integration points in the elements of set Copper in the .dat file.

Example files: beampt, beamrb, beamt4.

7.53 *ELSET

Keyword type: model definition

This option is used to assign elements to an element set. The parameter ELSET containing the name of the set is required (maximum 80 characters), whereas the parameter GENERATE (without value) is optional. If present, element ranges can be expressed by their initial value, their final value, and an increment. If a set with the same name already exists, it is reopened and

complemented. The name of a set is case insensitive. Internally, it is modified into upper case and a 'E' is appended to denote it as element set.

The following names are reserved (i.e. cannot be used by the user for other purposes than those for which they are reserved):

- FLUIDBLOCK: for block CFD-calculations

First line:

- *ELSET
- Enter any needed parameters and their values.

Following line if the GENERATE parameter is omitted:

- List of elements and/or sets of elements previously defined to be assigned to this element set (maximum 16 entries per line).

Repeat this line if needed.

Following line if the GENERATE parameter is included:

- First element in set.
- Last element in set.
- Increment in element numbers between elements in the set. Default is 1.

Repeat this line if needed.

Example:

```
*ELSET,ELSET=E1,GENERATE
20,25
*ELSET,ELSET=E2
E1,50,51
```

assigns the elements with numbers 20, 21, 22, 23, 24 and 25 to element set E1 and the elements with numbers 20, 21, 22, 23, 24, 25 (= set E1), 50 and 51 to element set E2.

Example files: segment, beampo1, beampset.

7.54 *END STEP

Keyword type: step

This option concludes the definition of a step.

First and only line:

- *END STEP

Example:

```
*END STEP
```

concludes a step. Each *STEP card must at some point be followed by an *END STEP card.

Example files: beamstraight, beamt.

7.55 *EQUATION

Keyword type: model definition (no REMOVE parameter) and step (only for REMOVE)

With this option, a linear equation constraint between arbitrary displacement components at any nodes where these components are active can be imposed. The equation is assumed to be homogeneous, and all variables are to be written on the left hand side of the equation. The first variable is considered to be the dependent one, and is subsequently eliminated from the equation, i.e. the corresponding degree of freedom does not show up in the stiffness matrix. This reduces the size of the matrix. A degree of freedom in a node can only be used once as the dependent node in an equation or in a SPC. For CFD-applications it is important for the stability of the calculation that the coefficient of the dependent degree of freedom is as large as possible compared to the coefficients of the independent degrees of freedom. For instance, setting the radial velocity orthogonal to the z-axis to zero corresponds to a MPC linking the x- and y-component of the velocity. The component with the largest coefficient should be chosen as dependent degree of freedom.

There are two optional parameters: REMOVE and REMOVE ALL. The parameter REMOVE can be used to remove equations corresponding with selected dependent degrees of freedom. These are listed underneath the *EQUATION keyword by node number, first degree of freedom and last degree of freedom. This triggers the deletion of all equations for which the dependent degree of freedom corresponds to the range from the first to the last degree of freedom of the selected node. If the last degree of freedom was omitted, it equals the first degree of freedom.

The parameter REMOVE ALL is used to remove all equations. Notice that the latter option removes all linear and nonlinear equations, irrespective whether they were defined with a *EQUATION card, a *MPC card or whether they were generated internally. Use of the REMOVE or the REMOVE ALL parameter usually makes sense only in step 2 or higher.

First line:

- *EQUATION
- one of the optional parameters, if applicable

Following lines in the absence of the REMOVE and REMOVE ALL parameter, in a set: First line of set:

- Number of terms in the equation.

Following lines of set (maximum 12 entries per line):

- Node number of the first variable.
- Degree of freedom at above node for the first variable.
- Value of the coefficient of the first variable.
- Node number of the second variable.
- Degree of freedom at above node for the second variable.
- Value of the coefficient of the second variable.
- Etc..

Continue, giving node number, degree of freedom, value of the coefficient, etc. Repeat the above line as often as needed if there are more than four terms in the *EQUATION. Specify exactly four terms per line for each constraint, except for the last line which may have less than four terms.

Following lines if the REMOVE parameter was selected:

- Node number or Node set label
- First degree of freedom
- Last degree of freedom (optional)

Repeat this line if needed.

If the REMOVE ALL parameter was selected no additional lines are necessary.

Example:

```
*EQUATION
3
3,2,2.3,28,1,4.05,17,1,-8.22
```

defines an equation of the form $2.3v_3 + 4.05u_{28} - 8.22u_{17} = 0$, where u, v and w are the displacement for degree of freedom one, two and three, respectively.

Example:

```
*EQUATION,REMOVE
10,1,3
```

removes all equations for which the dependent degree of freedom corresponds to the degrees of freedom 1, 2 or 3 of node 10.

Example files: achtel2, achtel29, achtel9, achtelcas, beamnlmpc, equirem1, equirem2, equirem3.

7.56 *EXPANSION

Keyword type: model definition, material

This option is used to define the thermal expansion coefficients of a material. They are interpreted as total expansion coefficients with respect to a reference temperature T_{ref} , i.e. the thermal strain ϵ_{th} of a material at a final temperature T and with initial temperature T_0 is determined by

$$\epsilon_{th} = \alpha(T)(T - T_{ref}) - \alpha(T_0)(T_0 - T_{ref}), \quad (859)$$

where $\alpha(T)$ is the thermal coefficient at a temperature T . There are two optional parameters TYPE and ZERO. Default for TYPE is TYPE=ISO, other values are TYPE=ORTHO for orthotropic materials and TYPE=ANISO for anisotropic materials. All constants may be temperature dependent. The parameter ZERO is used to determine the reference temperature, default is 0.

First line:

- *EXPANSION
- Enter the TYPE and ZERO parameters and their values, if needed

Following line for TYPE=ISO:

- α .
- Temperature.

Repeat this line if needed to define complete temperature dependence.

Following line for TYPE=ORTHO:

- α_{11} .
- α_{22} .
- α_{33} .
- Temperature.

Repeat this line if needed to define complete temperature dependence.

Following line for TYPE=ANISO:

- α_{11} .
- α_{22} .
- α_{33} .
- α_{12} .
- α_{13} .

- α_{23} .
- Temperature.

Repeat this line if needed to define complete temperature dependence.

Example:

```
*EXPANSION,ZERO=273.
12.E-6,373.
20.E-6,573.
```

tells you that the thermal strain in a body made of this material is $100. \times 12. \times 10^{-6} = 12. \times 10^{-4}$ if heated from $T=273$ to $T=373$, and $300 \times 20 \times 10^{-6} = 60 \times 10^{-4}$ if heated from $T=273$ to $T=573$.

Example files: beamt, beamt2.

7.57 *FEASIBLE DIRECTION

Keyword type: step

This procedure is used to calculate a feasible direction for an optimization calculation. It must be preceded by one or more *SENSITIVITY steps and the design variables must be of type coordinate. The sensitivities calculated in the sensitivity steps can be used as an objective or as constraints. The feasible direction step calculates how the steepest descent direction of the objective function (*OBJECTIVE) has to be modified to avoid the violation of nonlinear constraints (*CONSTRAINT) or geometric constraints (*GEOMETRIC CONSTRAINT). To calculate this modified descent direction two methods are available selected by the optional parameter METHOD. It can take the value GRADIENT DESCENT or GRADIENT PROJECTION. For details the user is referred to Section 6.9.24.

Default is the GRADIENT DESCENT method. It is an interior point method which means that the starting point for an optimization has to lie in the feasible domain. The influence of the constraints on the feasible direction is always taken into account independent of the distance to the constraint bound. This method aims to stay away from the constraint boundaries as long as possible on the way to the local optimum.

In contrast to that, the GRADIENT PROJECTION method is based on an active set strategy which means that the steepest descent direction is chosen as long as no constraint boundary is reached. As soon as a constraint boundary is active the feasible direction is calculated by projection the objective gradient on the subspace tangent of all active constraints.

The feasible direction procedure yields values for the motion of the design variables normal to the surface which is needed to reach the objective subject to the constraints. These values are normed to 1 (i.e. the maximum absolute value is 1) and they can be used for a subsequent mesh modification by applying them

as boundary conditions to the mesh in a linear elastic calculation. The input deck for this calculation is automatically generated in the feasible direction step and gets the name `jobname.equ`. Before creating this input deck, the values are scaled by the mesh modification factor, which the user specifies on the line underneath `*FEASIBLE DIRECTION`.

First line:

- `*FEASIBLE DIRECTION`
- Enter the parameter `METHOD` if needed and its value

Second line:

- Mesh modification size.

Example:

```
*FEASIBLE DIRECTION,METHOD=GRADIENT PROJECTION
.1
```

defines a feasible direction step with the gradient method for the treatment of the constraints. The maximum modification of the mesh is 0.1.

Example files: `opt1`, `opt3`.

7.58 *FILM

Keyword type: step

This option allows the specification of film heat transfer. This is convective heat transfer of a surface at temperature T and with film coefficient h to the environment at temperature T_0 . The environmental temperature T_0 is also called the sink temperature. The convective heat flux q satisfies:

$$q = h(T - T_0). \quad (860)$$

In order to specify which face the flux is entering or leaving the faces are numbered. The numbering depends on the element type.

For hexahedral elements the faces are numbered as follows (numbers are node numbers):

- Face 1: 1-2-3-4
- Face 2: 5-8-7-6
- Face 3: 1-5-6-2
- Face 4: 2-6-7-3
- Face 5: 3-7-8-4

- Face 6: 4-8-5-1

for tetrahedral elements:

- Face 1: 1-2-3
- Face 2: 1-4-2
- Face 3: 2-4-3
- Face 4: 3-4-1

and for wedge elements:

- Face 1: 1-2-3
- Face 2: 4-5-6
- Face 3: 1-2-5-4
- Face 4: 2-3-6-5
- Face 5: 3-1-4-6

for quadrilateral plane stress, plane strain and axisymmetric elements:

- Face 1: 1-2
- Face 2: 2-3
- Face 3: 3-4
- Face 4: 4-1
- Face N: in negative normal direction (only for plane stress)
- Face P: in positive normal direction (only for plane stress)

for triangular plane stress, plane strain and axisymmetric elements:

- Face 1: 1-2
- Face 2: 2-3
- Face 3: 3-1
- Face N: in negative normal direction (only for plane stress)
- Face P: in positive normal direction (only for plane stress)

for quadrilateral shell elements:

- Face NEG or 1: in negative normal direction
- Face POS or 2: in positive normal direction

- Face 3: 1-2
- Face 4: 2-3
- Face 5: 3-4
- Face 6: 4-1

for triangular shell elements:

- Face NEG or 1: in negative normal direction
- Face POS or 2: in positive normal direction
- Face 3: 1-2
- Face 4: 2-3
- Face 5: 3-1

The labels NEG and POS can only be used for uniform, non-forced convection and are introduced for compatibility with ABAQUS. Notice that the labels 1 and 2 correspond to the brick face labels of the 3D expansion of the shell (Figure 69).

for beam elements:

- Face 1: in negative 1-direction
- Face 2: in positive 1-direction
- Face 3: in positive 2-direction
- Face 5: in negative 2-direction

The beam face numbers correspond to the brick face labels of the 3D expansion of the beam (Figure 74).

Film flux characterized by a uniform film coefficient is entered by the distributed flux type label Fx where x is the number of the face, followed by the sink temperature and the film coefficient. If the film coefficient is nonuniform the label takes the form FxNUy and a user subroutine film.f must be provided specifying the value of the film coefficient and the sink temperature. The label can be up to 20 characters long. In particular, y can be used to distinguish different nonuniform film coefficient patterns (maximum 16 characters).

In case the element face is adjacent to a moving fluid the temperature of which is also unknown (forced convection), the distributed flux type label is FxFC where x is the number of the face. It is followed by the fluid node number it exchanges convective heat with and the film coefficient. To define a nonuniform film coefficient the label FxFCNUy must be used and a subroutine film.f defining the film coefficient be provided. The label can be up to 20 characters long. In particular, y can be used to distinguish different nonuniform film coefficient patterns (maximum 14 characters).

Optional parameters are OP, AMPLITUDE, TIME DELAY, FILM AMPLITUDE and FILM TIME DELAY. OP takes the value NEW or MOD. OP=MOD is default and implies that the film fluxes on different faces are kept over all steps starting from the last perturbation step. Specifying a film flux on a face for which such a flux was defined in a previous step replaces this value. OP=NEW implies that all previous film flux is removed. If multiple *FILM cards are present in a step this parameter takes effect for the first *FILM card only.

The AMPLITUDE parameter allows for the specification of an amplitude by which the sink temperature is scaled (mainly used for dynamic calculations). Thus, in that case the sink temperature values entered on the *FILM card are interpreted as reference values to be multiplied with the (time dependent) amplitude value to obtain the actual value. At the end of the step the reference value is replaced by the actual value at that time. In subsequent steps this value is kept constant unless it is explicitly redefined or the amplitude is defined using TIME=TOTAL TIME in which case the amplitude keeps its validity. The AMPLITUDE parameter has no effect on nonuniform and forced convective fluxes.

The TIME DELAY parameter modifies the AMPLITUDE parameter. As such, TIME DELAY must be preceded by an AMPLITUDE name. TIME DELAY is a time shift by which the AMPLITUDE definition it refers to is moved in positive time direction. For instance, a TIME DELAY of 10 means that for time t the amplitude is taken which applies to time $t-10$. The TIME DELAY parameter must only appear once on one and the same keyword card.

The FILM AMPLITUDE parameter allows for the specification of an amplitude by which the film coefficient is scaled (mainly used for dynamic calculations). Thus, in that case the film coefficient values entered on the *FILM card are interpreted as reference values to be multiplied with the (time dependent) amplitude value to obtain the actual value. At the end of the step the reference value is replaced by the actual value at that time, for use in subsequent steps. The FILM AMPLITUDE parameter has no effect on nonuniform fluxes.

The FILM TIME DELAY parameter modifies the FILM AMPLITUDE parameter. As such, FILM TIME DELAY must be preceded by an FILM AMPLITUDE name. FILM TIME DELAY is a time shift by which the FILM AMPLITUDE definition it refers to is moved in positive time direction. For instance, a FILM TIME DELAY of 10 means that for time t the amplitude is taken which applies to time $t-10$. The FILM TIME DELAY parameter must only appear once on one and the same keyword card.

Notice that in case an element set is used on any line following *FILM this set should not contain elements from more than one of the following groups: {plane stress, plane strain, axisymmetric elements}, {beams, trusses}, {shells, membranes}, {volumetric elements}.

In order to apply film conditions to a surface the element set label underneath may be replaced by a surface name. In that case the "x" in the flux type label is left out.

If more than one *FILM card occurs in the input deck the following rules apply: if the *FILM is applied to the same node and the same face as in a

previous application then the previous value and previous amplitude (including film amplitude) are replaced.

First line:

- *FILM
- Enter any needed parameters and their value

Following line for uniform, explicit film conditions:

- Element number or element set label.
- Film flux type label (Fx).
- Sink temperature.
- Film coefficient.

Repeat this line if needed.

Following line for nonuniform, explicit film conditions:

- Element number or element set label.
- Film flux type label (FxNUy).

Repeat this line if needed.

Following line for forced convection with uniform film conditions:

- Element number or element set label.
- Film flux type label (FxFC).
- Fluid node.
- Film coefficient.

Repeat this line if needed.

Following line for forced convection with nonuniform film conditions:

- Element number or element set label.
- Film flux type label (FxFCNUy).
- Fluid node.

Repeat this line if needed.

Example:

```
*FILM
20,F1,273.,.1
```

assigns a film flux to face 1 of element 20 with a film coefficient of 0.1 and a sink temperature of 273.

Example files: oneel20fi.

7.59 *FILTER

Keyword type: step

With *FILTER the sensitivities can be modified to obtain a more smooth result. It can only be used in a *SENSITIVITY step and at least one *DESIGN RESPONSE must have been defined before.

There are four optional parameters: TYPE, BOUNDARY WEIGHTING, EDGE PRESERVATION and DIRECTION WEIGHTING.

The filter itself is a monotonically decreasing function within a sphere at the node at stake taking the value 1 at the center of the sphere and 0 at its boundary. The TYPE of filter can be LINEAR, QUADRATIC, CUBIC or GAUSS. If no TYPE is specified, no filtering will be active.

With BOUNDARY WEIGHTING=YES the sensitivities near the boundary between the design space and the nodes not belonging to the design space are gradually decreased to zero. The distance across which this happens can be specified by the user. Default is no boundary weighting. If the BOUNDARY WEIGHTING parameter is active but no boundary weighting distance is given (or zero) the filter radius is taken as boundary weighting distance.

The EDGE PRESERVATION=YES parameter indicates that sharp corners at the boundary of the design space should be kept. This means that for the calculation of the normal on the design space, only the faces internal to the design space are used. Default is no edge preservation.

Finally, DIRECTION WEIGHTING=YES indicates that the values within the filter radius should be weighted with the scalar product of the local normal with the normal at the center of the filter.

First line:

- *FILTER and any appropriate parameters.

Second line (only necessary if TYPE and/or BOUNDARY WEIGHTING was selected):

- the filter radius
- the boundary weighting distance

Example:

```
*FILTER,TYPE=LINEAR
3.
```

defines linear filter with a filter radius of 3 length units. Boundary weighting, edge preservation and direction weighting are not active.

Example files: beam_sens_freq_coord1.

7.60 *FLUID CONSTANTS

Keyword type: model definition, material

With this option the specific heat at constant pressure and the dynamic viscosity of a gas or liquid can be defined. These properties are required for fluid dynamic network calculations. They can be temperature dependent.

First line:

- *FLUID CONSTANTS

Following line:

- Specific heat at constant pressure.
- Dynamic viscosity.
- Temperature.

Repeat this line if needed to define complete temperature dependence.

Example:

```
*FLUID CONSTANTS
1.032E9,71.1E-13,100.
```

defines the specific heat and dynamic viscosity for air at 100 K in a unit system using N, mm, s and K: $c_p = 1.032 \times 10^9 \text{mm}^2/\text{s}^2\text{K}$ and $\mu = 71.1 \times 10^{-13} \text{Ns}/\text{mm}^2$.

Example files: linearnet, branch1, branch2.

7.61 *FLUID SECTION

Keyword type: model definition

This option is used to assign material properties to network element sets. The parameters ELSET and MATERIAL are required, the parameters TYPE, OIL, CONSTANTS, LIQUID and MANNING are optional. The parameter ELSET defines the network element set to which the material specified by the parameter MATERIAL applies.

The parameter TYPE is only necessary in fluid dynamic networks in which the pressure and/or the mass flow are unknown in at least one node. In that case, the type of fluid section must be selected from the list in section 6.2.37 and the appropriate constants describing the section must be specified in the line(s) underneath the *FLUID SECTION keyword card, eight per line, except for the last line which can contain less.

The parameter OIL defines the material parameters used in two-phase flow in gas pipes, restrictors and branches. Its argument must be the name of a material defined using the *MATERIAL card.

With the parameter `CONSTANTS` the number of parameters needed to describe the type of fluid section can be specified. This parameter is only necessary for user-defined fluid section types. They start with “U” and can only be defined for compressible network elements. For further information the reader is referred to Section 6.4.25.

Elements of fluid section type `ORIFICE` with $C_d = 1$, `RESTRICTOR`, `BRANCH` and `VORTEX` can be used for gases and liquids. Default is gas. If they are used for liquids the parameter `LIQUID` should be used on the `*FLUID SECTION` card.

Finally, for elements of the liquid channel type friction is by default modeled with the White-Colebrook law. If the Manning coefficient is preferred, the parameter `MANNING` should be used.

First line:

- `*FLUID SECTION`
- Enter any needed parameters.

Following line (only necessary if `TYPE` was used):

- First constant
- Second constant
- etc (maximum eight constants on this line)

Repeat this line if more than eight constants are needed to describe the fluid section.

Example:

```
*FLUID SECTION,MATERIAL=NITROGEN,ELSET=Ea11
```

assigns material `NITROGEN` to all elements in (element) set `Ea11`.

Example:

```
*FLUID SECTION,MATERIAL=AIR,ELSET=Ea11,TYPE=ORIFICE_PK_MS
3.14,0.1,2.,0.01,0.1
```

assigns material `AIR` to all elements in set `Ea11`. The type of fluid section is an orifice with the c_d coefficient calculated following the formulas by Parker and Kercher [72], modified for the influence of the rotational velocity by McGreehan and Schotsch [55]. The area of the orifice is 3.14, the length is 0.1, the diameter is 2., the inlet corner radius is 0.01 and the pipe diameter ratio is 0.1.

Example files: `furnace`, `beamhtfc`, `branch1`.

7.62 *FREQUENCY

Keyword type: step

This procedure is used to determine eigenfrequencies and the corresponding eigenmodes of a structure. The frequency range of interest can be specified by entering its lower and upper value. However, internally only as many frequencies are calculated as requested in the first field beneath the *FREQUENCY keyword card. Accordingly, if the highest calculated frequency is smaller than the upper value of the requested frequency range, there is no guarantee that all eigenfrequencies within the requested range were calculated. If the PERTURBATION parameter is used in the *STEP card, the load active in the last *STATIC step, if any, will be taken as preload. Otherwise, no preload will be active.

There are four optional parameters SOLVER, STORAGE, GLOBAL and CYCMPC. SOLVER specifies which solver is used to perform a decomposition of the linear equation system. This decomposition is done only once. It is repeatedly used in the iterative procedure determining the eigenvalues. The following solvers can be selected:

- the SGI solver
- PaStiX
- PARDISO
- SPOOLES [3, 4].
- TAUCS
- MATRIXSTORAGE. This is not really a solver. Rather, it is an option allowing the user to store the stiffness and mass matrix.

Default is the first solver which has been installed of the following list: SGI, PaStiX, PARDISO, SPOOLES and TAUCS. If none is installed, no eigenvalue analysis can be performed.

The SGI solver should by now be considered as outdated. SPOOLES is very fast, but has no out-of-core capability: the size of systems you can solve is limited by your RAM memory. With 32GB of RAM you can solve up to 1,000,000 equations. TAUCS is also good, but my experience is limited to the LL^T decomposition, which only applies to positive definite systems. It has an out-of-core capability and also offers a LU decomposition, however, I was not able to run either of them so far. PARDISO is the Intel proprietary solver and is about a factor of two faster than SPOOLES. The most recent solver we tried is the freeware solver PaStiX from INRIA. It is really fast and can use the GPU. For large problems and a high end Nvidia graphical card (32 GB of RAM) we got an acceleration of a factor between 3 and 8 compared to PARDISO. We modified PaStiX for this, therefore you have to download PaStiX from our website and compile it for your system. This can be slightly tricky, however, it is worth it!

If the `MATRIXSTORAGE` option is used, the stiffness and mass matrices are stored in files `jobname.sti` and `jobname.mas`, respectively. These are ASCII files containing the nonzero entries (occasionally, they can be zero; however, none of the entries which are not listed are nonzero). Each line consists of two integers and one real: the row number, the column number and the corresponding value. The entries are listed column per column. In addition, a file `jobname.dof` is created. It has as many entries as there are rows and columns in the stiffness and mass matrix. Each line contains a real number of the form “a.b”. Part a is the node number and b is the global degree of freedom corresponding to selected row. Notice that the program stops after creating these files. No further steps are treated. Consequently, `*FREQUENCY`, `SOLVER=MATRIXSTORAGE` only makes sense as the last step in a calculation.

The parameter `STORAGE` indicates whether the eigenvalues, eigenmodes, mass and stiffness matrix should be stored in binary form in file `jobname.eig` for further use in a `*MODAL DYNAMICS`, `*STEADY STATE DYNAMICS` or `*SENSITIVITY` procedure. Default is `STORAGE=NO`. Specify `STORAGE=YES` if storage is requested.

The parameters `GLOBAL` and `CYCMPC` only make sense in the presence of `SOLVER=MATRIXSTORAGE`. `GLOBAL` indicates whether the matrices should be stored in global coordinates, irrespective of whether a local coordinates system for any of the nodes in the structure was defined. Default is `GLOBAL=YES`. For `GLOBAL=NO` the matrices are stored in local coordinates and the directions in file `jobname.dof` are local directions. Notice that the `GLOBAL=NO` only works if no single or multiple point constraints were defined and one and the same coordinate system was defined for ALL nodes in the structure. The second parameter (`CYCMPC`) specifies whether any cyclic multiple point constraints should remain active while assembling the stiffness and mass matrix before storing them. Default is `CYCMPC=ACTIVE`. `CYCMPC=INACTIVE` means that all cyclic MPC's and any other MPC's containing dependent nodes belonging to cyclic MPC's are removed before assembling the matrices. The `CYCMPC` parameter only makes sense if `GLOBAL=YES`, since only then are MPC's allowed.

For the iterative eigenvalue procedure ARPACK [48] is used. The eigenfrequencies are always stored in file `jobname.dat`.

At the start of a frequency calculation all single point constraint boundary conditions, which may be zero due to previous steps, are set to zero.

First line:

- *FREQUENCY

Second line:

- Number of eigenfrequencies desired.
- Lower value of requested eigenfrequency range (in cycles/time; default:0).

- Upper value of requested eigenfrequency range (in cycles/time; default: ∞).

Example:

```
*FREQUENCY
10
```

requests the calculation of the 10 lowest eigenfrequencies and corresponding eigenmodes.

Example files: beam8f, beamf.

7.63 *FRICTION

Keyword type: model definition, surface interaction and step

With this option the friction behavior of a surface interaction can be defined. The friction behavior is optional for contact analyses. There are no parameters.

The frictional behavior defines the relationship between the shear stress in the contact area and the relative tangential displacement between the slave and the master surface. It is characterized by a linear range with tangent λ (stick slope) for small relative displacements (stick) followed by a horizontal upper bound (slip) given by μp , where μ is the friction coefficient and p the local pressure (Figure 131). μ is dimensionless and usually takes values between 0.1 and 0.5, λ has the dimension of force per volume and should be chosen to be about 100 times smaller than the spring constant. If no value for λ is specified a default is taken equal to the first elastic constant of the first encountered material in the input deck divided by 2.

For face-to-face penalty contact with `PRESSURE-OVERCLOSURE=TIED` the value of the friction coefficient is irrelevant.

First line:

- *FRICTION

Following line for all types of analysis except modal dynamics:

- $\mu(> 0)$.
- $\lambda(> 0)$.

Example:

```
*FRICTION
0.2,5000.
```

defines a friction coefficient of 0.2 and a stick slope of 5000.

Example files: friction1, friction2.

7.64 *GAP

Keyword type: model definition

This option is used to define a gap geometry. The parameter ELSET is required and defines the set of gap elements to which the geometry definition applies. Right now, all gap elements must be of the GAPUNI type and can be defined by an *ELEMENT card. The gap geometry is defined by its clearance d and direction \mathbf{n} (a vector of length 1). Let the displacement vector of the first node of a GAPUNI element be \mathbf{u}_1 and the displacement vector of the second node \mathbf{u}_2 . Then, the gap condition is defined by:

$$d + \mathbf{n} \cdot (\mathbf{u}_2 - \mathbf{u}_1) \geq 0. \quad (861)$$

The gap condition is internally simulated by a nonlinear spring of the type used in node-to-face contact with a linear pressure-overclosure curve, cf. Figure 130 in which the pressure is to be replaced by the force. The defaults for the spring stiffness (in units of force/displacement) and the tensile force at $-\infty$ are 10^{12} and 10^{-3} , respectively. They can be changed by the user.

First line:

- *GAP
- Enter the ELSET parameter and its value.

Second line :

- gap clearance
- first component of the normalized gap direction
- second component of the normalized gap direction
- third component of the normalized gap direction
- not used
- spring stiffness (default 10^{12} [force]/[length])
- tensile force at $-\infty$ (default 10^{-3} [force]).

Example:

```
*GAP,ELSET=E1
0.5,0.,1.,0.
```

defines a clearance of 0.5 and the global y-axis as gap direction for all gap elements contained in element set E1.

Example files: gap.

7.65 *GAP CONDUCTANCE

Keyword type: model definition, surface interaction

This option allows for the definition of the conductance across a contact pair. The conductance is the ratio of the heat flow across the contact location and the temperature difference between the corresponding slave and master surface (unit: $[\text{energy}]/([\text{time}][\text{area}][\text{temperature}]])$). The gap conductance is a property of the nonlinear contact spring elements generated during contact. This means that heat flow will only take place at those slave nodes, at which a contact spring element was generated. Whether or not a contact spring element is generated depends on the pressure-overclosure relationship on the *SURFACE BEHAVIOR card.

- for node-to-face contact:
 - if the pressure-overclosure relationship is linear or tabular a contact spring element is generated if the gap clearance does not exceed $c_0\sqrt{A}$, where A is the representative area at the slave node, or 10^{-10} if this area is zero (can happen for 2-dimensional elements). Default for c_0 is 10^{-3} , its value can be changed for a linear pressure-overclosure relationship.
 - if the pressure-overclosure relationship is exponential a contact spring area is generated if the gap clearance does not exceed c_0 (cf. *SURFACE BEHAVIOR).
- for face-to-face contact:
 - if the pressure-overclosure relationship is tied a contact spring element is generated no matter the size of the clearance
 - else a contact spring element is generated if the clearance is non-positive.

The conductance coefficient can be defined as a function of the contact pressure and the mean temperature of slave and master surface. Alternatively, the conductance can be coded by the user in the user subroutine gapcon.f, cf Section 8.4.11. In the latter case the option USER must be used on the *GAP CONDUCTANCE card.

First line:

- *GAP CONDUCTANCE
- Enter the parameter USER if appropriate

Following sets of lines define the conductance coefficients in the absence of the USER parameter: First line in the first set:

- Conductance.

- Contact pressure.
- Temperature.

Use as many lines in the first set as needed to define the conductance versus pressure curve for this temperature.

Use as many sets as needed to define complete temperature dependence.

Example:

```
*GAP CONDUCTANCE
100. , , 273.
```

defines a conductance coefficient with value 100. for all contact pressures and all temperatures.

Example files: .

7.66 *GAP HEAT GENERATION

Keyword type: model definition, surface interaction and step

This keyword is used to take heat generation due to frictional contact into account. It can only be used for face-to-face penalty contact and is only activated in the presence of slip. The heat flowing into the slave surface amounts to:

$$W = f\eta \mathbf{F} \cdot \mathbf{v}, \quad (862)$$

where f is the surface weighting factor, η the heat conversion factor, \mathbf{F} the tangential force and \mathbf{v} the differential velocity between master and slave surface. The heat flowing into the master surface correspondingly amounts to:

$$W = (1 - f)\eta \mathbf{F} \cdot \mathbf{v}. \quad (863)$$

The heat conversion factor specifies the amount of power converted into heat. The user specifies the heat conversion factor, the surface weighting factor and the differential tangential velocity (in size). If the latter is set to a number smaller than zero, the differential velocity is calculated internally from the velocity of the adjacent surfaces. The ability for the user to specify the differential velocity is useful in axisymmetric structures for which the differential velocity is oriented in circumferential direction (cf. example ring3.inp).

The *GAP HEAT GENERATION keyword must be placed underneath the *SURFACE INTERACTION card to which it belongs. Furthermore, it can only be used in *COUPLED and *UNCOUPLED TEMPERATURE-DISPLACEMENT calculations. It is only used in face-to-face penalty contact.

There is one optional parameter USER. In the presence of this parameter the gap heat generation data are obtained from user subroutine fricheat.f (cf.

Section 8.4.12). This user subroutine must have been coded, compiled and linked by the user before calling CalculiX.

First line:

- *GAP HEAT GENERATION
- Enter USER, if appropriate.

The next line is only needed in the absence of USER:

- heat conversion factor η ($0 < \eta \leq 1$).
- surface weighting factor f ($0 \leq f \leq 1$).
- differential tangential velocity

Example:

```
*GAP HEAT GENERATION
0.7,0.3,2000.
```

defines a heat conversion factor of 0.7, a surface weighting factor of 0.3 (i.e. 30 % of the heat goes into the slave surface, 70 % into the master surface) and a differential tangential velocity of 2000 [L]/[t], where [L] is the unit of length used by the user and [t] the unit of time.

Example files: ring3.

7.67 *GEOMETRIC CONSTRAINT

Keyword type: step

With *GEOMETRIC CONSTRAINT one can define geometric constraints in a feasible direction step. It can only be used for design variables of type COORDINATE.

Right now, the following geometric constraint types are allowed:

- MAXSHRINKAGE: the structure is not allowed to shrink more than the defined value for the given node set
- MAXGROWTH: the structure is not allowed to grow more than the defined value for the given node set.
- PACKAGING: the structure is not allowed to grow beyond a limiting node set for the given node set.
- MAXMEMBERSIZE: the minimum distance between each node of a given set and the nodes of an opposite node set is not allowed to exceed a given size in the user's units.

- **MINMEMBERSIZE**: the minimum distance between each node of a given set and the nodes of an opposite node set is not allowed to fall below a given size in the user's units.

There are now parameters on this keyword.

First line:

- ***GEOMETRIC CONSTRAINT**.

Second line:

- the type of the geometric constraint
- a node set
- an opposite node set (for **MAXMEMBERSIZE** and **MINMEMBERSIZE**) or a bounding node set (for **PACKAGING**)
- an absolute value (for **MAXMEMBERSIZE**, **MINMEMBERSIZE**, **MAXGROWTH** and **MAXSHRINKAGE**)

Repeat this line if needed.

Example:

```
*FEASIBLE DIRECTION
*GEOMETRIC CONSTRAINT
MAXMEMBERSIZE,N1,N2,.1
```

specifies that the distance between each node of set N1 and the nodes in set N2 should not exceed .1 in the user's units.

Example files: .

7.68 *GEOMETRIC TOLERANCES

Keyword type: step

This option allows the specification of the geometric tolerances in a ***ROBUST DESIGN** analysis. It can be defined on a node-by-node basis and consists of a mean value and a standard deviation, both in length units. In a robust design analysis random field vectors are generated representing the geometric tolerances up to a specified accuracy.

There is one required parameter **TYPE=NORMAL** and there is one optional parameter **CONSTRAINED**. **TYPE=NORMAL** specifies that the tolerances are normally distributed. Right now, this is the only distribution allowed. The **CONSTRAINED** parameter enforces a smooth transition between those parts in the structure for which tolerances were defined and the remaining parts.

First line:

- *GEOMETRIC TOLERANCES
- Enter any needed parameters and their value

Second line:

- Node number or node set label.
- Mean value of the tolerance.
- Standard deviation of the tolerance.

Repeat this line if needed.

Example:

```
*GEOMETRIC TOLERANCES,TYPE=NORMAL,CONSTRAINED
N1,1.5,3.7
```

assigns normally distributed tolerances with a mean value of 1.5 length units and a standard deviation of 3.7 length units to all nodes in set N1. The random fields are constrained, i.e. a smooth transition of the random field vectors is requested between the nodes in set N1 and the remaining nodes in the structure.

Example files: beamprand.

7.69 *GREEN

Keyword type: step

This procedure is used to calculate the Green function due to unit forces at specific nodes in specific global directions. The Green functions are calculated for each unit force separately. The unit forces are defined by a *CLOAD card (the force value specified by the user is immaterial, a unit force is taken). For details the user is referred to Section 6.9.26.

There are two optional parameters: SOLVER and STORAGE. SOLVER specifies which solver is used to perform a decomposition of the linear equation system. This decomposition is done only once. It is repeatedly used in determining all Green functions. The following solvers can be selected:

- the SGI solver
- PaStiX
- PARDISO
- SPOOLES [3, 4].
- TAUCS

Default is the first solver which has been installed of the following list: SGI, PaStiX, PARDISO, SPOOLES and TAUCS. If none is installed, a Green function calculation is not possible.

The SGI solver should by now be considered as outdated. SPOOLES is very fast, but has no out-of-core capability: the size of systems you can solve is limited by your RAM memory. With 32GB of RAM you can solve up to 1,000,000 equations. TAUCS is also good, but my experience is limited to the LL^T decomposition, which only applies to positive definite systems. It has an out-of-core capability and also offers a LU decomposition, however, I was not able to run either of them so far. PARDISO is the Intel proprietary solver and is about a factor of two faster than SPOOLES. The most recent solver we tried is the freeware solver PaStiX from INRIA. It is really fast and can use the GPU. For large problems and a high end Nvidia graphical card (32 GB of RAM) we got an acceleration of a factor between 3 and 8 compared to PARDISO. We modified PaStiX for this, therefore you have to download PaStiX from our website and compile it for your system. This can be slightly tricky, however, it is worth it!

The parameter STORAGE indicates whether the scalar frequencies, Green functions, mass and stiffness matrix should be stored in binary form in file jobname.eig for further use in a *SENSITIVITY procedure. Default is STORAGE=NO. Specify STORAGE=YES if storage is requested.

First line:

- *GREEN
- Enter SOLVER, if needed, and its value.

Example:

```
*GREEN, SOLVER=PARDISO
```

defines a Green function step and selects the PARDISO solver as linear equation solver. For this to work, the PARDISO solver must have been linked with CalculiX.

Example files: green1.

7.70 *HCF

Keyword type: step

This keyword card is used to consider High Cycle Fatigue (HCF) in a crack propagation calculation. To this end, a modal calculation (*FREQUENCY) must have been performed for the uncracked structure and the resulting stresses must have been stored in a frd-file. Right now, no cyclic symmetry is allowed in this modal calculation. There are three required parameters INPUT, MODE and MISSION STEP and two optional parameters MAX CYCLE and SCALING.

The INPUT parameter is used to denote the frd-file containing the stress results of the modal calculation for the uncracked structure. It must have been performed in a separate calculation. Temperature results are not necessary, since the temperature of the LCF (static) calculation defined on the *CRACK PROPAGATION card is used.

With the MODE parameter the user can select which mode in the modal calculation is to be used. This mode is scaled with the value given by the SCALING parameter (default is 1.) and superimposed on the static step defined by the MISSION STEP parameter.

If HCF crack propagation is not allowed (MAX CYCLE = 0; this is the default) the calculation stops as soon as HCF propagation is detected. If it is allowed (MAX CYCLE > 0) HCF calculation is calculated for the actual crack propagation increment and the next increment is started. In that case, no LCF propagation is determined.

First line:

- *HCF
- Enter any parameters and their value

Example:

```
*HCF,INPUT=hcf.frd,MODE=3,SCALING=0.01,MISSION STEP=4
```

defines high cycle fatigue using the stress results for mode 3 from file hcf.frd, scaling them by 0.01 and superimposing them on the fourth step in the mission. This mission must have been defined using the INPUT parameter on the *CRACK PROPAGATION card.

Example files: crackIIcumhcf, crackIIcumhcf2.

7.71 *HEADING

Keyword type: model definition

The heading block allows for a short problem description for identification and retrieval purposes. This description is reproduced at the top of the output file.

First line:

- *HEADING

Following line:

- Description of the problem.

Example:

*HEADING

Cantilever beam under tension and bending.

gives a title to the problem.

Example files: beampt, segment1.

7.72 *HEAT TRANSFER

Keyword type: step

This procedure is used to perform a pure heat transfer analysis. A heat transfer analysis is always nonlinear since the material properties depend on the solution, i.e. the temperature.

There are nine optional parameters: SOLVER, DIRECT, STEADY STATE, FREQUENCY, MODAL DYNAMIC, STORAGE, DELTMX, TIME RESET and TOTAL TIME AT START.

SOLVER determines the package used to solve the ensuing system of equations. The following solvers can be selected:

- the SGI solver
- PaStiX
- PARDISO
- SPOOLES [3, 4].
- TAUCS
- the iterative solver by Rank and Ruecker [79], which is based on the algorithms by Schwarz [85].
- MATRIXSTORAGE. This is not really a solver. Rather, it is an option allowing the user to store the stiffness and mass matrix.

Default is the first solver which has been installed of the following list: SGI, PaStiX, PARDISO, SPOOLES and TAUCS. If none is installed, the default is the iterative solver, which comes with the CalculiX package.

The SGI solver should by now be considered as outdated. SPOOLES is very fast, but has no out-of-core capability: the size of systems you can solve is limited by your RAM memory. With 32GB of RAM you can solve up to 1,000,000 equations. TAUCS is also good, but my experience is limited to the LL^T decomposition, which only applies to positive definite systems. It has an out-of-core capability and also offers a LU decomposition, however, I was not able to run either of them so far. PARDISO is the Intel proprietary solver and is about a factor of two faster than SPOOLES. The most recent solver we tried is the freeware solver PaStiX from INRIA. It is really fast and can use the GPU. For

large problems and a high end Nvidia graphical card (32 GB of RAM) we got an acceleration of a factor between 3 and 8 compared to PARDISO. We modified PaStiX for this, therefore you have to download PaStiX from our website and compile it for your system. This can be slightly tricky, however, it is worth it!

What about the iterative solver? If SOLVER=ITERATIVE SCALING is selected, the pre-conditioning is limited to a scaling of the diagonal terms, SOLVER=ITERATIVE CHOLESKY triggers Incomplete Cholesky pre-conditioning. Cholesky pre-conditioning leads to a better convergence and maybe to shorter execution times, however, it requires additional storage roughly corresponding to the non-zeros in the matrix. If you are short of memory, diagonal scaling might be your last resort. The iterative methods perform well for truly three-dimensional structures. For instance, calculations for a hemisphere were about nine times faster with the ITERATIVE SCALING solver, and three times faster with the ITERATIVE CHOLESKY solver than with SPOOLES. For two-dimensional structures such as plates or shells, the performance might break down drastically and convergence often requires the use of Cholesky pre-conditioning. SPOOLES (and any of the other direct solvers) performs well in most situations with emphasis on slender structures but requires much more storage than the iterative solver.

If the MATRIXSTORAGE option is used, the conductivity and capacity matrices are stored in files jobname.con and jobname.sph (specific heat), respectively. These are ASCII files containing the nonzero entries (occasionally, they can be zero; however, none of the entries which are not listed are nonzero). Each line consists of two integers and one real: the row number, the column number and the corresponding value. The entries are listed column per column. In addition, a file jobname.dof is created. It has as many entries as there are rows and columns in the stiffness and mass matrix. Each line contains a real number of the form "a.b". Part a is the node number and b is the global degree of freedom corresponding to selected row (in this case 0 for the thermal degree of freedom). Notice that the program stops after creating these files. No further steps are treated. Consequently, *HEAT TRANSFER, MATRIXSTORAGE only makes sense as the last step in a calculation.

The parameter DIRECT indicates that automatic incrementation should be switched off. The increments will have the fixed length specified by the user on the second line.

The parameter STEADY STATE indicates that only the steady state should be calculated. For such an analysis the loads are by default applied in a linear way. Other loading patterns can be defined by an *AMPLITUDE card. If the STEADY STATE parameter is absent, the calculation is assumed to be time dependent and a transient analysis is performed. For a transient analysis the specific heat of the materials involved must be provided and the loads are by default applied by their full strength at the start of the step.

In a static step, loads are by default applied in a linear way. Other loading patterns can be defined by an *AMPLITUDE card.

The parameter FREQUENCY indicates that a frequency calculation should be performed. In a frequency step the homogeneous governing equation is

solved, i.e. no loading applies, and the corresponding eigenfrequencies and eigenmodes are determined. This option is especially useful if the heat transfer option is used as an alias for true Helmholtz-type problems, e.g. in acoustics. The option FREQUENCY cannot (yet) be applied to cyclic symmetry calculations.

The parameter MODAL DYNAMIC is used for dynamic calculations in which the response is built as a linear combination of the eigenmodes of the system. It must be preceded by a *HEAT TRANSFER, FREQUENCY, STORAGE=YES procedure, either in the same deck, or in a previous run, either of which leads to the creation of a file with name jobname.eig containing the eigenvalues and eigenmodes of the system. A MODAL DYNAMIC procedure is necessarily linear and ideally suited of problems satisfying the classical wave equation (Helmholtz problem characterized by a second derivative in time, thus exhibiting a hyperbolic behavior), e.g. linear acoustics.

The parameter STORAGE indicates whether the eigenvalues, eigenmodes, mass and stiffness matrix should be stored in binary form in file jobname.eig for further use in a *MODAL DYNAMICS or *STEADY STATE DYNAMICS procedure. Default is STORAGE=NO. Specify STORAGE=YES if storage is requested.

The parameter DELTMX can be used to limit the temperature change in two subsequent increments. If the temperature change exceeds DELTMX the increment is restarted with a size equal to D_A times DELTMX divided by the temperature change. The default for D_A is 0.85, however, it can be changed by the *CONTROLS keyword. DELTMX is only active in transient calculations. Default value is 10^{30} .

The parameter TIME RESET can be used to force the total time at the end of the present step to coincide with the total time at the end of the previous step. If there is no previous step the targeted total time is zero. If this parameter is absent the total time at the end of the present step is the total time at the end of the previous step plus the time period of the present step (2nd parameter underneath the *HEAT TRANSFER keyword). Consequently, if the time at the end of the previous step is 10. and the present time period is 1., the total time at the end of the present step is 11. If the TIME RESET parameter is used, the total time at the beginning of the present step is 9. and at the end of the present step it will be 10. This is sometimes useful if transient heat transfer calculations are preceded by a stationary heat transfer step to reach steady state conditions at the start of the transient heat transfer calculations. Using the TIME RESET parameter in the stationary step (the first step in the calculation) will lead to a zero total time at the start of the subsequent instationary step.

Finally, the parameter TOTAL TIME AT START can be used to set the total time at the start of the step to a specific value.

First line:

- *HEAT TRANSFER
- Enter any needed parameters and their values.

Second line if FREQUENCY nor MODAL DYNAMIC is not selected:

- Initial time increment. This value will be modified due to automatic incrementation, unless the parameter DIRECT was specified (default 1.).
- Time period of the step (default 1.).
- Minimum time increment allowed. Only active if DIRECT is not specified. Default is the initial time increment or 1.e-5 times the time period of the step, whichever is smaller.
- Maximum time increment allowed. Only active if DIRECT is not specified. Default is 1.e+30.

Example:

```
*HEAT TRANSFER,DIRECT
.1,1.
```

defines a static step and selects the SPOOLES solver as linear equation solver in the step (default). The second line indicates that the initial time increment is .1 and the total step time is 1. Furthermore, the parameter DIRECT leads to a fixed time increment. Thus, if successful, the calculation consists of 10 increments of length 0.1.

Example files: beamhtcr, oneel20fi, oneel20rs.

Second line if FREQUENCY is selected:

- Number of eigenfrequencies desired.
- Lower value of requested eigenfrequency range (in cycles/time; default:0).
- Upper value of requested eigenfrequency range (in cycles/time; default: ∞).

Example:

```
*HEAT TRANSFER,FREQUENCY
8
```

defines a frequency step for the heat transfer equation. The eight lowest eigenvalues and corresponding eigenmodes are calculated. Notice that for the heat equation the following relation applies between the eigenvalue λ and eigenfrequency ω :

$$\lambda = -i\omega. \quad (864)$$

If, on the other hand, the heat transfer option is used as an alias for the Helmholtz equation, e.g. for acoustic problems, the same relationship as in elastodynamics

$$\lambda = \omega^2 \quad (865)$$

applies.

Second line if MODAL DYNAMIC is selected:

- Initial time increment. This value will be modified due to automatic incrementation, unless the parameter DIRECT was specified (default 1.).
- Time period of the step (default 1.).

Example files: aircolumn.

7.73 *HYPERELASTIC

Keyword type: model definition, material

This option is used to define the hyperelastic properties of a material. There are two optional parameters. The first one defines the model and can take one of the following strings: ARRUDA-BOYCE, MOONEY-RIVLIN, NEO HOOKE, OGDEN, POLYNOMIAL, REDUCED POLYNOMIAL or YEOH. The second parameter N makes sense for the OGDEN, POLYNOMIAL and REDUCED POLYNOMIAL model only, and determines the order of the strain energy potential. Default is the POLYNOMIAL model with N=1. All constants may be temperature dependent.

Let \bar{I}_1, \bar{I}_2 and J be defined by:

$$\bar{I}_1 = III_C^{-1/3} I_C \quad (866)$$

$$\bar{I}_2 = III_C^{-2/3} II_C \quad (867)$$

$$J = III_C^{1/2} \quad (868)$$

where I_C, II_C and III_C are the invariants of the right Cauchy-Green deformation tensor $C_{KL} = x_{k,K}x_{k,L}$. The tensor C_{KL} is linked to the Lagrange strain tensor E_{KL} by:

$$2E_{KL} = C_{KL} - \delta_{KL} \quad (869)$$

where δ is the Kronecker symbol.

The Arruda-Boyce strain energy potential takes the form:

$$\begin{aligned} U = & \mu \left\{ \frac{1}{2}(\bar{I}_1 - 3) + \frac{1}{20\lambda_m^2}(\bar{I}_1^2 - 9) + \frac{11}{1050\lambda_m^4}(\bar{I}_1^3 - 27) \right. \\ & \left. + \frac{19}{7000\lambda_m^6}(\bar{I}_1^4 - 81) + \frac{519}{673750\lambda_m^8}(\bar{I}_1^5 - 243) \right\} \\ & + \frac{1}{D} \left(\frac{J^2 - 1}{2} - \ln J \right) \end{aligned} \quad (870)$$

The Mooney-Rivlin strain energy potential takes the form:

$$U = C_{10}(\bar{I}_1 - 3) + C_{01}(\bar{I}_2 - 3) + \frac{1}{D_1}(J - 1)^2 \quad (871)$$

The Mooney-Rivlin strain energy potential is identical to the polynomial strain energy potential for $N = 1$.

The Neo-Hooke strain energy potential takes the form:

$$U = C_{10}(\bar{I}_1 - 3) + \frac{1}{D_1}(J - 1)^2 \quad (872)$$

The Neo-Hooke strain energy potential is identical to the reduced polynomial strain energy potential for $N = 1$.

The polynomial strain energy potential takes the form:

$$U = \sum_{i+j=1}^N C_{ij}(\bar{I}_1 - 3)^i(\bar{I}_2 - 3)^j + \sum_{i=1}^N \frac{1}{D_i}(J - 1)^{2i} \quad (873)$$

In CalculiX $N \leq 3$.

The reduced polynomial strain energy potential takes the form:

$$U = \sum_{i=1}^N C_{i0}(\bar{I}_1 - 3)^i + \sum_{i=1}^N \frac{1}{D_i}(J - 1)^{2i} \quad (874)$$

In CalculiX $N \leq 3$. The reduced polynomial strain energy potential can be viewed as a special case of the polynomial strain energy potential

The Yeoh strain energy potential is nothing else but the reduced polynomial strain energy potential for $N = 3$.

Denoting the principal stretches by λ_1 , λ_2 and λ_3 (λ_1^2 , λ_2^2 and λ_3^2 are the eigenvalues of the right Cauchy-Green deformation tensor) and the deviatoric stretches by $\bar{\lambda}_1$, $\bar{\lambda}_2$ and $\bar{\lambda}_3$, where $\bar{\lambda}_i = III_C^{-1/6} \lambda_i$, the Ogden strain energy potential takes the form:

$$U = \sum_{i=1}^N \frac{2\mu_i}{\alpha_i^2} (\bar{\lambda}_1^{\alpha_i} + \bar{\lambda}_2^{\alpha_i} + \bar{\lambda}_3^{\alpha_i} - 3) + \sum_{i=1}^N \frac{1}{D_i}(J - 1)^{2i}. \quad (875)$$

The input deck for a hyperelastic material looks as follows:

First line:

- *HYPERELASTIC
- Enter parameters and their values, if needed

Following line for the ARRUDA-BOYCE model:

- μ .

- λ_m .
- D .
- Temperature

Repeat this line if needed to define complete temperature dependence.

Following line for the MOONEY-RIVLIN model:

- C_{10} .
- C_{01} .
- D_1 .
- Temperature

Repeat this line if needed to define complete temperature dependence.

Following line for the NEO HOOKE model:

- C_{10} .
- D_1 .
- Temperature.

Repeat this line if needed to define complete temperature dependence.

Following line for the OGDEN model with N=1:

- μ_1 .
- α_1 .
- D_1 .
- Temperature.

Repeat this line if needed to define complete temperature dependence.

Following line for the OGDEN model with N=2:

- μ_1 .
- α_1 .
- μ_2 .
- α_2 .
- D_1 .
- D_2 .
- Temperature.

Repeat this line if needed to define complete temperature dependence.

Following lines, in a pair, for the OGDEN model with N=3: First line of pair:

- μ_1 .
- α_1 .
- μ_2 .
- α_2 .
- μ_3 .
- α_3 .
- D_1 .
- D_2 .

Second line of pair:

- D_3 .
- Temperature.

Repeat this pair if needed to define complete temperature dependence.

Following line for the POLYNOMIAL model with N=1:

- C_{10} .
- C_{01} .
- D_1 .
- Temperature.

Repeat this line if needed to define complete temperature dependence.

Following line for the POLYNOMIAL model with N=2:

- C_{10} .
- C_{01} .
- C_{20} .
- C_{11} .
- C_{02} .
- D_1 .
- D_2 .
- Temperature.

Repeat this line if needed to define complete temperature dependence.

Following lines, in a pair, for the POLYNOMIAL model with N=3: First line of pair:

- C_{10} .
- C_{01} .
- C_{20} .
- C_{11} .
- C_{02} .
- C_{30} .
- C_{21} .
- C_{12} .

Second line of pair:

- C_{03} .
- D_1 .
- D_2 .
- D_3 .
- Temperature.

Repeat this pair if needed to define complete temperature dependence.

Following line for the REDUCED POLYNOMIAL model with N=1:

- C_{10} .
- D_1 .
- Temperature.

Repeat this line if needed to define complete temperature dependence.

Following line for the REDUCED POLYNOMIAL model with N=2:

- C_{10} .
- C_{20} .
- D_1 .
- D_2 .
- Temperature.

Repeat this line if needed to define complete temperature dependence.

Following line for the REDUCED POLYNOMIAL model with N=3:

- C_{10} .
- C_{20} .
- C_{30} .
- D_1 .
- D_2 .
- D_3 .
- Temperature.

Repeat this line if needed to define complete temperature dependence.

Following line for the YEOH model:

- C_{10} .
- C_{20} .
- C_{30} .
- D_1 .
- D_2 .
- D_3 .
- Temperature.

Repeat this line if needed to define complete temperature dependence.

Example:

```
*HYPERELASTIC,OGDEN,N=1
3.488,2.163,0.
```

defines an ogden material with one term: $\mu_1 = 3.488$, $\alpha_1 = 2.163$, $D_1=0$. Since the compressibility coefficient was chosen to be zero, it will be replaced by CalculiX by a small value to ensure some compressibility to guarantee convergence (cfr. page 257).

Example files: beamnh, beamog.

7.74 *HYPERFOAM

Keyword type: model definition, material

This option is used to define a hyperfoam material. There is one optional parameters, N. N determines the order of the strain energy potential. Default is N=1. All constants may be temperature dependent.

The hyperfoam strain energy potential takes the form

$$U = \sum_{i=1}^N \frac{2\mu_i}{\alpha_i^2} \left[\lambda_1^{\alpha_i} + \lambda_2^{\alpha_i} + \lambda_3^{\alpha_i} - 3 + \frac{1}{\beta_i} (J^{-\alpha_i \beta_i} - 1) \right] \quad (876)$$

where λ_1 , λ_2 and λ_3 are the principal stretches. The parameters β_i are related to the Poisson coefficients ν_i by:

$$\beta_i = \frac{\nu_i}{1 - 2\nu_i} \quad (877)$$

and

$$\nu_i = \frac{\beta_i}{1 + 2\beta_i}. \quad (878)$$

First line:

- *HYPERFOAM
- Enter parameters and their values, if needed

Following line for N=1:

- μ_1 .
- α_1 .
- ν_1 .
- Temperature.

Repeat this line if needed to define complete temperature dependence.

Following line for N=2:

- μ_1 .
- α_1 .
- μ_2 .
- α_2 .
- ν_1 .
- ν_2 .

- Temperature.

Repeat this line if needed to define complete temperature dependence.

Following lines, in a pair, for N=3: First line of pair:

- μ_1 .
- α_1 .
- μ_2 .
- α_2 .
- μ_3 .
- α_3 .
- ν_1 .
- ν_2 .

Second line of pair:

- ν_3 .
- Temperature.

Repeat this pair if needed to define complete temperature dependence.

Example:

```
*HYPERFOAM,N=2
0.164861,8.88413,2.302e-5,-4.81798,0.,0.
```

defines a hyperfoam material with two terms in the series.

Example files: beamhf.

7.75 *INCLUDE

Keyword type: step or model definition

The include statement allows to store part of the input deck in another file. There is only one required parameter, INPUT, taking the name of the file in or without double quotes ("). The double quotes are needed if the file name contains one or more blanks.

First line:

- *INCLUDE
- Enter the parameter and its value.

Example:

```
*INCLUDE,INPUT=/home/guido/test/beam.spc
```

is at execution time replaced by the contents of file /home/guido/test/beam.spc.

Example files: .

7.76 *INITIAL CONDITIONS

Keyword type: model definition

This option is used to define initial temperatures, initial velocities, initial stresses and initial plastic strains. There are two parameters: TYPE and USER. The parameter TYPE is required. It can take the following values:

- TYPE=DISPLACEMENT: initial displacements
- TYPE=FLUID VELOCITY: initial fluid velocities for 3D fluid calculations
- TYPE=MASS FLOW: initial mass flow for networks
- TYPE=PLASTIC STRAIN: initial inelastic strains
- TYPE=PRESSURE: initial static fluid pressures for 3D fluid calculations
- TYPE=SOLUTION: initial internal variables
- TYPE=STRESS: initial stresses
- TYPE=TEMPERATURE: initial temperatures for structural, network or 3D fluid calculations
- TYPE=TOTAL PRESSURE: initial total pressures for network calculations
- TYPE=TURBULENCE: turbulence parameters
- TYPE=VELOCITY: initial structural velocities (for dynamic calculations)

For shell elements TYPE=TEMPERATURE can be used to define an initial temperature gradient in addition to an initial temperature. The temperature applies to nodes in the reference surface, the gradient acts in normal direction. For beam elements two gradients can be defined: one in 1-direction and one in 2-direction. Default for the gradients is zero.

The plastic strain components defined with this option are subtracted from the strain components computed from the displacement field. If thermal strains are relevant they are additionally subtracted. The resulting strain is used to compute the stress and tangent stiffness matrix using the appropriate constitutive equations.

The parameter `USER` can only be used if `TYPE=STRESS` or `TYPE=SOLUTION` is specified. In that case, the user must define the initial stresses or internal variables by user routine `sigini.f` or `sdvini.f`, respectively.

Please note that vector and tensor quantities have to be provided in the GLOBAL (rectangular) coordinate system, no matter whether an `*ORIENTATION` card or `*TRANSFORM` card applies to the corresponding element or node, respectively.

First line:

- `*INITIAL CONDITIONS`
- Enter any needed parameters and their values.

Following line for `TYPE=DISPLACEMENT`:

- Node number or node set label.
- Degree of freedom in the GLOBAL coordinate system.
- Magnitude of the displacement.

Following line for `TYPE=PLASTIC STRAIN`:

- Element number.
- Integration point number.
- Value of first plastic strain component (`xx`) in the GLOBAL coordinate system `x-y-z`.
- Value of second plastic strain component (`yy`) in the GLOBAL coordinate system `x-y-z`.
- Value of third plastic strain component (`zz`) in the GLOBAL coordinate system `x-y-z`.
- Value of fourth plastic strain component (`xy`) in the GLOBAL coordinate system `x-y-z`.
- Value of fifth plastic strain component (`xz`) in the GLOBAL coordinate system `x-y-z`.
- Value of sixth plastic strain component (`yz`) in the GLOBAL coordinate system `x-y-z`.

Repeat this line if needed. The strain components should be given as Lagrange strain components for nonlinear calculations and linearized strain components for linear computations.

Following line for `TYPE=PRESSURE`, `TYPE=TOTAL PRESSURE` or `TYPE=MASS FLOW`:

- Node number or node set label.
- Static pressure, total pressure or mass flow value at the node.

Repeat this line if needed.

Following line for TYPE=SOLUTION if USER is not specified:

- Element number.
- Integration point number.
- Value of first internal variable.
- Value of second internal variable.
- Etc.

Repeat this line if needed. Each line should contain exactly 8 entries (including the element and integration point number in the first line), except for the last line, which can contain less. For instance, if the number of internal variables is 11, the first line contains 6 and the second 5. If you have 20 internal variables, the first line contains 6, the second 8 and the third 6. The number of internal variables must be specified by using the *DEPVAR card.

There is no line following the first one for TYPE=SOLUTION,USER.

Following line for TYPE=STRESS if USER is not specified:

- Element number.
- Integration point number.
- Value of first stress component (xx) in the GLOBAL coordinate system x-y-z.
- Value of second stress component (yy) in the GLOBAL coordinate system x-y-z.
- Value of third stress component (zz) in the GLOBAL coordinate system x-y-z.
- Value of fourth stress component (xy) in the GLOBAL coordinate system x-y-z.
- Value of fifth stress component (xz) in the GLOBAL coordinate system x-y-z.
- Value of sixth stress component (yz) in the GLOBAL coordinate system x-y-z.
- Etc.

Repeat this line if needed. The stress components should be given in the form of second Piola-Kirchhoff stresses.

There is no line following the first one for TYPE=STRESS,USER.

Following line for TYPE=TEMPERATURE:

- Node number or node set label.
- Initial temperature value at the node.
- Initial temperature gradient in normal direction (shells) or in 2-direction (beams).
- Initial temperature gradient in 1-direction (beams).

Repeat this line if needed.

Following line for TYPE=VELOCITY or TYPE=FLUID VELOCITY:

- Node number or node set label.
- Degree of freedom in the GLOBAL coordinate system.
- Magnitude of the velocity.

Following line for TYPE=TURBULENCE:

- Node number or node set label.
- First turbulence parameter.
- Second turbulence parameter, if any.

Use as many entries as turbulence parameters. Right now, only 2-parameter models are implemented.

Examples:

```
*INITIAL CONDITIONS,TYPE=TEMPERATURE
Nall,273.
```

assigns the initial temperature $T=273.$ to all nodes in (node) file Nall.

```
*INITIAL CONDITIONS,TYPE=VELOCITY
18,2,3.15
```

assigns the initial velocity 3.15 to degree of freedom 2 of node 18.

Example files: beam20t, beamnlt, beamt3, resstress1, resstress2, resstress3, inistrain.

7.77 *INITIAL MESH

Keyword type: step definition

In terms of an optimization process, in which the mesh is changed in several iterations, one can define the original nodal coordinates at the beginning of the optimization with *INITIAL MESH. It is needed for the status of the *GEOMETRIC CONSTRAINT, e.g. FIXGROWTH or FIXSHRINKAGE. It can only be used for design variables of type COORDINATE and only makes sense in a `FEASIBLE DIRECTION` step.

First line:

- *INITIAL MESH

Following lines:

- Node number.
- Value of the first global rectangular coordinate.
- Value of the second global rectangular coordinate.
- Value of the third global rectangular coordinate.

Examples:

```
*INITIAL MESH
  1,      0.000000,      0.000000,      0.000000
  2,      1.000000,      0.000000,      0.000000
  3,      1.000000,      1.000000,      0.000000
  4,      0.000000,      1.000000,      0.000000
...
```

Example files: .

7.78 *INITIAL STRAIN INCREASE

Keyword type: step

This option is used to define an increase of initial strains. The values are added to the initial strains already present in the model. The use of this option requires the previous use of *INITIAL CONDITIONS, TYPE=PLASTIC STRAIN or *MODEL CHANGE, TYPE=ELEMENT, ADD or *MODEL CHANGE, TYPE=ELEMENT, ADD=STRAIN FREE.

The resulting initial strain components are subtracted from the strain components computed from the displacement field. If thermal strains are relevant they are additionally subtracted. The resulting strain is used to compute the stress and tangent stiffness matrix using the appropriate constitutive equations.

Please note that the strains have to be provided in the GLOBAL (rectangular) coordinate system, no matter whether an *ORIENTATION card or *TRANSFORM card applies to the corresponding element.

First line:

- *INITIAL STRAIN INCREASE

Following line:

- Element number.
- Integration point number.
- Value of first initial strain increase component (xx) in the GLOBAL coordinate system x-y-z.
- Value of second initial strain increase component (yy) in the GLOBAL coordinate system x-y-z.
- Value of third initial strain increase component (zz) in the GLOBAL coordinate system x-y-z.
- Value of fourth initial strain increase component (xy) in the GLOBAL coordinate system x-y-z.
- Value of fifth initial strain increase component (xz) in the GLOBAL coordinate system x-y-z.
- Value of sixth initial strain increase component (yz) in the GLOBAL coordinate system x-y-z.

Repeat this line if needed. The strain components should be given as Lagrange strain components for nonlinear calculations and linearized strain components for linear computations.

Examples:

```
*INITIAL STRAIN INCREASE
20,5,0.01,0.,0.01,0.,0.,0.
```

increases the initial strain at integration point 5 of element 20 by a normal global x and normal global z component of 0.01, the other strains remain unchanged.

Example files: inistrain2.

7.79 *KINEMATIC

Keyword type: model definition

With this keyword kinematic constraints can be established between each node belonging to an element surface and a reference node. A kinematic constraint specifies that the displacement in a certain direction *i* at a node corresponds to the rigid body motion of this node about a reference node. Therefore, the location of the reference node is important.

This card must be immediately preceded by a *COUPLING keyword card. If no ORIENTATION was specified on the *COUPLING card, the degrees of freedom entered immediately below the *KINEMATIC card (these are the degrees of freedom *i* which take part in the rigid body motion) apply to the global rectangular system, if an ORIENTATION was used, they apply to the local system. If the local system is cylindrical, the degrees of freedom 1, 2 and 3 correspond to the displacement in radial direction, the circumferential angle and the displacement in axial direction, respectively (as defined by the *ORIENTATION card; the position of the reference node is immaterial to that respect).

The degrees of freedom in the reference node (1 up to 3 for translations, 4 up to 6 for rotations; they apply to the global system unless a *TRANSFORM card was defined for the reference node) can be constrained by a *BOUNDARY card. Alternatively, a force (degrees of freedom 1 up to 3) or moment (degrees of freedom 4 up to 6) can be applied by a *CLOAD card. In the latter case the resulting displacements (degrees of freedom 1 up to 3) can be printed in the .dat file by selecting U on the *NODE PRINT card for the reference node. However, the corresponding selection of RF on the *NODE PRINT card does not work for the reference node. Instead, the user should use *SECTION PRINT to obtain the global force and moment on the selected surface.

First line:

- *KINEMATIC

Following line:

- first degree of freedom (only 1, 2 or 3 allowed)
- last degree of freedom (only 1, 2 or 3 allowed); if left blank the last degree of freedom coincides with the first degree of freedom.

Repeat this line if needed to constrain other degrees of freedom.

Example:

```
*NODE
262, .5, .5, 8.
*ORIENTATION, NAME=OR1, SYSTEM=CYLINDRICAL
.5, .5, 0., .5, .5, 1.
*COUPLING, REF NODE=262, SURFACE=S1, ORIENTATION=OR1, CONSTRAINT NAME=CN1
```

```

*KINEMATIC
2
*STEP
*STATIC
*BOUNDARY
262,6,6,.01

```

specifies a moment of size 0.01 about the z-axis through node 262. The rotation (angle) about this axis of each node belonging to the facial surface SURF will be identical and such that the resulting moment in the structure agrees with the applied moment. Since only local degree of freedom 2 takes part in the rigid body motion, the radial and axial displacement in the nodes belonging to surface S1 is left completely free.

Example files: coupling2, coupling3.

7.80 *MAGNETIC PERMEABILITY

Keyword type: model definition, material

This option is used to define the magnetic permeability of a material. There are no parameters. The material is supposed to be isotropic. The constant may be temperature dependent. The unit of the magnetic permeability coefficient is the unit of force divided by the square of the unit of electrical current. In SI-units this is N/A² or Henry/m. The magnetic permeability may be viewed as the product of the relative magnetic permeability (dimensionless) μ_r with the permeability of vacuum μ_0 .

Following the magnetic permeability constant the user is supposed to define the domain for which this material is used. In an electromagnetic calculation there are three domains:

1. the air, which is the P-domain (domain 1)
2. the bodies, which is the A,V-domain (domain 2)
3. that part of the air, which, if filled with body material, ensures that the bodies are simply connected; this is the A-domain (domain 3). If there is only one body and if it is such that it is naturally simply connected the A-domain is empty.

For more details the reader is referred to the section on electromagnetism.

First line:

- *MAGNETIC PERMEABILITY

Following line:

- μ .

- number of the domain
- Temperature.

Repeat this line if needed to define complete temperature dependence.

Example:

```
*MAGNETIC PERMEABILITY  
1.255987E-6,2
```

tells you that the magnetic permeability coefficient is 1.255987×10^{-6} , independent of temperature (if SI-units are used this is the magnetic permeability of copper). The domain for which this material is defined is the A,V-domain.

Example files: induction.

7.81 *MASS

Keyword type: model definition

This option allows the specification of the nodal mass in the MASS elements of the model. There is one required parameter ELSET specifying the element set for which this mass applies. It should contain only MASS elements. The mass value is applied in each of the elements of the set separately.

First line:

- *MASS
- Enter the parameter ELSET and its value.

Following line:

- Mass.

Example:

```
*MASS,ELSET=E1  
1.e3
```

assigns a mass of 1000. in each element belonging to element set E1.

Example files: .

7.82 *MASS FLOW

Keyword type: step

This option allows the specification of a mass flow through a face in 3-D Navier-Stokes calculations.

In order to specify which face the flow is entering or leaving the faces are numbered. The numbering depends on the element type.

For hexahedral elements the faces are numbered as follows (numbers are node numbers):

- Face 1: 1-2-3-4
- Face 2: 5-8-7-6
- Face 3: 1-5-6-2
- Face 4: 2-6-7-3
- Face 5: 3-7-8-4
- Face 6: 4-8-5-1

for tetrahedral elements:

- Face 1: 1-2-3
- Face 2: 1-4-2
- Face 3: 2-4-3
- Face 4: 3-4-1

for wedge elements:

- Face 1: 1-2-3
- Face 2: 4-5-6
- Face 3: 1-2-5-4
- Face 4: 2-3-6-5
- Face 5: 3-1-4-6

The mass flow is entered as a uniform flow with flow type label Mx where x is the number of the face. Right now, only zero mass flow is allowed, i.e. no flow is entering or leaving the domain. There are no parameters for this keyword card.

In order to apply a mass flow to a surface the element set label underneath may be replaced by a surface name. In that case the mass flow type label takes the value "M" without any number following.

First line:

- *MASS FLOW

Following line:

- Element number or element set label.
- Mass flow type label.
- Zero.

Repeat this line if needed.

Example:

```
*MASS FLOW
20,M2
```

assigns a zero mass flow to face 2 of element 20.

Example files: bumpsubfine (large fluid examples).

7.83 *MATERIAL

Keyword type: model definition

This option is used to indicate the start of a material definition. A material data block is defined by the options between a *MATERIAL line and either another *MATERIAL line or a keyword line that does not define material properties. All material options within a data block will be assumed to define the same material. If a property is defined more than once for a material, the last definition is used. There is one required parameter, NAME, defining the name of the material with which it can be referenced in element property options (e.g. *SOLID SECTION). The name can contain up to 80 characters.

Material data requests outside the defined ranges are extrapolated in a constant way and a warning is generated. Be aware that this occasionally occurs due to rounding errors.

First line:

- *MATERIAL
- Enter the NAME parameter and its value.

Example:

```
*MATERIAL,NAME=EL
```

starts a material block with name EL.

Example files: fullseg, beamnldype, beamog.

7.84 *MATRIX ASSEMBLE

Keyword type: model definition

This keyword card is used to define a substructure (sometimes called a superelement in other codes), cf. Section 6.2.48. There are two required parameters NAME and STIFFNESS FILE and one optional parameter MASS FILE.

The name of a substructure consists of at most 4 characters. Internally, a “U” is appended in front of them and the substructure is considered as a special kind of user element. Therefore, the name of a substructure should not coincide with the characters following “U” of any coded user elements (such as S3 for the US3 element).

The STIFFNESS FILE refers to the file containing the entries in the stiffness matrix. It is assumed to be symmetric and only the upper triangular values or the lower triangular values should be contained (including the diagonal) in the form

```
row node,row dof,column node,column dof,value
```

one entry per line. The order is irrelevant. The same applies to the mass matrix. The latter is only needed in frequency (*FREQUENCY) or dynamic (*DYNAMIC) calculations. The name of the stiffness and the mass matrix can be at most 80 characters long.

First line:

- *MATRIX ASSEMBLE
- Enter any parameters and their value

Example:

```
*MATRIX ASSEMBLE,NAME=TEST,STIFFNESSFILE=beampsuper.stiff
```

defines a substructure with name TEST. The stiffness matrix is stored in file “beampsuper.stiff”.

Example files: beamfsuper,beampsuper, segmentsuper.

7.85 *MEMBRANE SECTION

Keyword type: model definition

This option is used to assign material properties to membrane element sets. The syntax is identical to *SHELL SECTION, therefore the user is referred to that section for further details

Example files: membrane1, membrane2, membrane3.

7.86 *MODAL DAMPING

Keyword type: step

This card is used within a step in which the *MODAL DYNAMIC or *STEADY STATE DYNAMICS procedure has been selected. There are two optional, mutually exclusive parameters: RAYLEIGH and MODAL=DIRECT (default).

If MODAL=DIRECT is selected the user can specify the viscous damping factor ζ for each mode separately. This is the default. Direct damping is not allowed in combination with nonzero single point constraints in a *MODAL DYNAMIC procedure (however, in a *STEADY STATE DYNAMICS procedure it is).

If RAYLEIGH is selected Rayleigh damping is applied in a global way, i.e. the damping matrix $[C]$ is taken to be a linear combination of the stiffness matrix $[K]$ and the mass matrix $[M]$:

$$[C] = \alpha [M] + \beta [K]. \quad (879)$$

The coefficients apply to all modes. The corresponding viscous damping factor ζ_j for mode j amounts to:

$$\zeta_j = \frac{\alpha}{2\omega_j} + \frac{\beta\omega_j}{2}. \quad (880)$$

Consequently, α damps the low frequencies, β damps the high frequencies.

The *MODAL DAMPING keyword can be used in any step to redefine damping values defined in a previous step.

First line:

- *MODAL DAMPING, RAYLEIGH
- Enter any needed parameters and their values.

Second line if MODAL=DIRECT is selected (or, since this is default, if no additional parameter is entered):

- lowest mode of the range
- highest mode of the range (default is lowest mode of the range)
- viscous damping factor ζ for modes between (and including) the lowest and highest mode of the range

Repeat this line if needed.

Second line if RAYLEIGH is selected:

- not used (kept for compatibility reasons with ABAQUS)
- not used (kept for compatibility reasons with ABAQUS)
- Coefficient of the mass matrix α .

- Coefficient of the stiffness matrix β .

Example:

```
*MODAL DAMPING,RAYLEIGH
, ,0. ,2.e-4
```

indicates that the damping matrix is obtained by multiplying the stiffness matrix with $2 \cdot 10^{-4}$

Example files: beamdy3, beamdy4, beamdy5, beamdy6.

7.87 *MODAL DYNAMIC

Keyword type: step

This procedure is used to calculate the response of a structure subject to dynamic loading. Although the deformation up to the onset of the dynamic calculation can be nonlinear, this procedure is basically linear and assumes that the response can be written as a linear combination of the lowest modes of the structure. To this end, these modes must have been calculated in a previous *FREQUENCY,STORAGE=YES step (not necessarily in the same calculation; notice that if in the frequency step the parameter PERTURBATION was used on the *STEP card, PERTURBATION must also be used on the *STEP card in the modal dynamics step). In the *MODAL DYNAMIC step the eigenfrequencies, modes and mass matrix are recovered from the file jobname.eig. The time period of the loading is characterized by its total length and the length of an increment. Within each increment the loading is assumed to be linear, in which case the solution is exact apart from modeling inaccuracies and the fact that not all eigenmodes are used. The number of eigenmodes used is taken from the previous *FREQUENCY step. Since a modal dynamic step is a perturbation step about some static state (a zero state if the parameter PERTURBATION was not used on the *STEP card), all previous loading is removed. The loading defined within the step is multiplied by the amplitude history for each load as specified by the AMPLITUDE parameter on the loading card, if any. If no amplitude applies all loading is applied at the start of the step. Loading histories extending beyond the amplitude time scale are extrapolated in a constant way. The absence of the AMPLITUDE parameter on a loading card leads to a constant load.

There are four optional parameters: SOLVER, DIRECT, DELTMX, and STEADY STATE. SOLVER determines the package used to solve for the steady state solution in the presence of nonzero displacement boundary conditions. The following solvers can be selected:

- the SGI solver
- PaStiX
- PARDISO

- SPOOLES [3, 4].
- TAUCS

Default is the first solver which has been installed of the following list: SGI, PaStiX, PARDISO, SPOOLES and TAUCS. If none is installed, an error is issued.

The SGI solver should by now be considered as outdated. SPOOLES is very fast, but has no out-of-core capability: the size of systems you can solve is limited by your RAM memory. With 32GB of RAM you can solve up to 1,000,000 equations. TAUCS is also good, but my experience is limited to the LL^T decomposition, which only applies to positive definite systems. It has an out-of-core capability and also offers a LU decomposition, however, I was not able to run either of them so far. PARDISO is the Intel proprietary solver and is about a factor of two faster than SPOOLES. The most recent solver we tried is the freeware solver PaStiX from INRIA. It is really fast and can use the GPU. For large problems and a high end Nvidia graphical card (32 GB of RAM) we got an acceleration of a factor between 3 and 8 compared to PARDISO. We modified PaStiX for this, therefore you have to download PaStiX from our website and compile it for your system. This can be slightly tricky, however, it is worth it!

The parameters DIRECT and DELTMX are linked. The parameter DIRECT controls the increment size. If DIRECT=NO the size of increments is variable. It is determined by the requirement that the change in forces within an increment should not exceed the value of DELTMX. Therefore, if the user specifies DIRECT=NO a value for DELTMX has to be provided. Default is DIRECT=YES (or, equivalently DIRECT without any argument). In the latter case the value of DELTMX is irrelevant. The modal forces are the scalar product of the system force vector with each of the selected (mass normalized) eigenmodes. The unit of the modal forces is force times square root of length.

The parameter STEADY STATE can be used to continue a modal dynamics calculation until steady state has been reached. In that case the total time period is set to 10.¹⁰ and does not have to be specified by the user. Instead, the user defines the maximum allowable relative error for the solution to be considered to be steady state. For instance, if the user sets this number to 0.01 steady state will be reached if the change in the largest solution variable (displacements or temperatures, depending on the kind of analysis) does not exceed 1%.

First line:

- *MODAL DYNAMIC
- enter the SOLVER parameter and its value, if needed.

Second line if STEADY STATE is not active:

- Initial time increment. This value will be modified due to automatic incrementation, if DIRECT=NO was specified. If no value is given, the initial time increment equals the time period of the step.

- Time period of the step.
- Minimum time increment allowed. Only active if DIRECT=NO is specified. Default is the initial time increment or 1.e-10 times the time period of the step, whichever is smaller.
- Maximum time increment allowed. Only active if DIRECT=NO is specified. Default is 1.e+30.

Second line if STEADY STATE is active:

- Initial time increment. This value will be modified due to automatic incrementation if DIRECT=NO was specified.
- Relative error for steady state conditions to be satisfied.
- Minimum time increment allowed. Only active if DIRECT=NO is specified. Default is the initial time increment or 1.e-10 times the time period of the step, whichever is smaller.
- Maximum time increment allowed. Only active if DIRECT=NO is specified. Default is 1.e+30.

Example:

```
*MODAL DYNAMIC
1.E-5,1.E-4
```

defines a modal dynamic procedure with time increment 10^{-5} and time period 10^{-4} . The time increment is kept constant.

Example:

```
*MODAL DYNAMIC,STEADY STATE
1.E-5,1.E-2
```

defines a modal dynamic procedure with initial time increment 10^{-5} and relative error 10^{-2} . The time increment is kept constant.

Example files: beamdy1, beamdy2, beamdy3, beamdy4, beamdy5, beamdy6, beamdy17.

7.88 *MODEL CHANGE

Keyword type: step

With this option one can activate or deactivate elements and contact pairs. Furthermore, one can turn the mechanical strain in existing elements into residual strain at the start of a new step.

One can deactivate or activate any element which has been defined in the model section of the input deck. Before the first step all elements are by default activated. There is one required parameter TYPE=ELEMENT and there are two mutually exclusive parameters ADD and REMOVE. One- and two-dimensional elements which are expanded in CalculiX (such as plane stress or shell elements) cannot be removed in the first step (to circumvent this restriction a dummy first step doing nothing can be inserted). The ADD parameter can be complemented by the modifiers STRAIN FREE or WITH STRAIN (ADD=STRAIN FREE and ADD=WITH STRAIN, respectively). If ADD=STRAIN FREE is selected the strains at the time of adding the element, if any, are modified by artificial initial strains such that the resulting stress tensor is zero. In that sense the elements are stress free rather than strain free. With ADD=WITH STRAIN the strains at the time of activation are not modified. Default is STRAIN FREE.

To activate or deactivate contact between two surfaces, contact must have been defined between these surfaces using a *CONTACT PAIR card before the first step. By default all contact pairs are activated before the first step. There is one required parameter TYPE=CONTACT PAIR and there are two mutually exclusive parameters ADD and REMOVE.

Finally, one can turn the mechanical strain from the end of the last step into a residual strain by using the parameter MECHSTRAINTORESIDUAL. If no new loading is applied in the actual step this will result in zero stress provided the force equilibrium is still satisfied. This is for instance the case when the loading purely consists of prescribed displacements. No elements are added or deleted.

First line:

- *MODEL CHANGE
- enter the required parameter TYPE=CONTACT PAIR or TYPE=ELEMENT and one of the mutually exclusive parameters ADD and REMOVE.

Following line for TYPE=ELEMENT:

- List of elements and/or sets of elements to be activated or deactivated (maximum 16 entries per line).

Repeat this line if needed

Following line for TYPE=CONTACT PAIR:

- Name of the slave surface (can be nodal or element face based).
- Name of the master surface (must be based on element faces).

Only one such line is allowed; repeat *MODEL CHANGE if several contact pairs are to be modified.

Example:

```
*MODEL CHANGE,TYPE=CONTACT PAIR,REMOVE
dep,ind
```

deactivates contact between the surfaces dep and ind.

Example files: modelchel,modelchel2

7.89 *MOHR COULOMB

Keyword type: model definition, material

This keyword is used to define the friction angle and dilation angle for the yield surface and the flow rule, respectively, of a Mohr-Coulomb material. The theory for this plasticity model is described in Section 6.8.11. There are no parameters for this keyword.

The temperature dependence is taken into account in a piecewise linear way based on the data at discrete temperature points.

The use of a *MOHR COULOMB card requires a *MOHR COULOMB HARDENING card within the same material definition in order to define the cohesion stress c .

Notice that for $\phi = \psi$ one obtains associative plasticity and for $\phi = \psi = 0$ the model reduces to Tresca plasticity.

First line:

- *MOHR COULOMB

Following line:

- Friction angle ϕ in degrees.
- Dilation angle ψ in degrees.
- Temperature.

Repeat this line if needed to define complete temperature dependence.

Example:

```
*MOHR COULOMB
20.,10.,294.
```

defines a Mohr-Coulomb material for temperature T=294. Since the definition includes values for only one temperature, they are valid for all temperatures.

Example files: mohr1, mohr2.

7.90 *MOHR COULOMB HARDENING

Keyword type: model definition, material

This keyword is used to define the (isotropic) hardening behavior of a Mohr-Coulomb material. The theory for this plasticity model is described in Section 6.8.11. There are no parameters for this keyword.

The temperature dependence is taken into account in a piecewise linear way based on the data at discrete temperature points. These temperature points should be identical to those used underneath the *MOHR COULOMB card. The use of a *MOHR COULOMB HARDENING card requires a *MOHR COULOMB card within the same material definition.

First line:

- *MOHR COULOMB HARDENING

Following sets of lines define the isotropic hardening curve: First line in the first set:

- Cohesion yield stress c .
- Equivalent plastic strain.
- Temperature.

Use as many lines in the first set as needed to define the complete hardening curve for this temperature.

Use as many sets as needed to define complete temperature dependence.

Example:

```
*MOHR COULOMB HARDENING
10.,0.,294.
100.,1.,294.
```

defines the hardening curve for a Mohr-Coulomb material for temperature $T=294$. The cohesion stress c is 10. for zero equivalent plastic strain and 100. for an equivalent plastic strain of 1 (= 100 %). In between linear interpolation is applied. Since the definition includes values for only one temperature, they are valid for all temperatures.

Example files: mohr1, mohr2.

7.91 *MPC

Keyword type: model definition

With this keyword card a multiple point constraint is defined, usually a nonlinear one. Right now, four different MPC's can be selected.

- A plane MPC (name PLANE). This MPC specifies that all nodes listed within this MPC card should stay in a plane. The first three nodes are the defining nodes and should not lie on a line. For all subsequent nodes a nonlinear MPC is generated expressing that they stay within the plane. Notice that the plane can move during deformation, depending on the motion of the defining nodes.
- A straight line MPC (name STRAIGHT). This MPC expresses that all nodes listed within this MPC card should stay on a straight line. The first two nodes are the defining nodes and should not coincide. For all subsequent nodes two nonlinear MPC's are generated expressing that they stay on the straight line. Notice that the straight line can move during deformation, depending on the motion of its defining nodes.
- A beam MPC (name BEAM). This MPC involves exactly two nodes the distance between which is kept constant during the calculation.
- A user MPC (name to be defined by the user). With this option the user can define new nonlinear MPC's. Examples are given in Section 8.7, e.g. the mean rotation MPC.

A *MPC card automatically triggers the NLGEOM parameter, i.e. a geometrically nonlinear calculation is performed, except if the MPC is a mean rotation MPC.

There are no parameters for this keyword card.

First line:

- *MPC

Second line:

- MPC name
- list of nodes participating in the MPC: maximum 15 entries. Zero entries are discarded.

Following lines (as many as needed):

- list of nodes participating in the MPC: maximum 16 entries. Zero entries are discarded.

Example:

```
*MPC
PLANE,3,8,15,39,14
```

specifies that nodes 3, 8, 15, 39 and 14 should stay in a plane. The plane is defined by nodes 3, 8 and 15. They should not be co-linear.

Example files: beammr, beamplane, beamstraight.

7.92 *NETWORK MPC

Keyword type: model definition

With this option, an equation between variables in a network (total temperature and total pressure at the end nodes of a network element, mass flow in the middle node) can be created. The corresponding degrees of freedom are:

- total temperature: 0
- mass flow: 1
- total pressure: 2

The use of *NETWORK MPC requires the coding of subroutines `networkmpc_lhs.f` and `networkmpc_rhs.f` by the user. In these routines the user defines the MPC (linear or nonlinear) using the information entered underneath *NETWORK MPC. The syntax is identical to *EQUATION except for an additional parameter TYPE specifying the type of MPC. Using this type the user can distinguish between different kinds of MPC in the `networkmpc_lhs.f` and `networkmpc_rhs.f` subroutines.

For instance, suppose the user wants to define a network MPC of the form:

$$f := ap_t(node_1) + bp_t^2(node_2) = 0 \quad (881)$$

specifying that the total pressure in node 1 should be $(-b/a)$ times the square of the total pressure in node 2. There are 2 degrees of freedom involved: dof 2 in node 1 and dof 2 in node 2. Underneath *NETWORK MPC the user defines the coefficients and degrees of freedom of the terms involved:

```
*NETWORK MPC,TYPE=QUADRATIC
2
node1,2,a,node2,2,b
```

All this information including the type of the MPC is transferred to the `networkmpc_lhs.f` and `networkmpc_rhs.f` subroutines. In `networkmpc_rhs.f` the user has to code the calculation of $-f$, in `networkmpc_lhs.f` the calculation of the derivative of f w.r.t. each degree of freedom occurring in the MPC. This has been done for TYPE=QUADRATIC and the reader is referred to the source code and example `networkmpc.inp` for further details.

7.93 *NO ANALYSIS

Keyword type: step

This procedure is used for input deck and geometry checking only. No calculation is performed. There are no parameters.

First and only line:

- *NO ANALYSIS

Example:

```
*NO ANALYSIS
```

requests the no analysis procedure, in which the set of equations is built but not solved (the Jacobian determinant is checked).

Example files: beamnoan.

7.94 *NODAL THICKNESS

Keyword type: model definition

This option is used to assign a thickness to a node or to a node set. There are no parameters. This keyword only makes sense for nodes belonging to plane stress/strain elements, shell elements and beam elements. For all of these except for the beam elements one thickness value should be given. For plane stress/strain and shell elements this is the thickness in normal direction. The normal direction can be defined by using the *NORMAL keyword card. If none is defined, the normal is calculated based on the geometrical data. For beam elements two thicknesses can be defined: one in 1-direction and one in 2-direction. The 1-direction can be defined on the *BEAM SECTION card, the 2-direction by the *NORMAL card.

The *NODAL THICKNESS card takes precedence over any other thickness definitions if the NODAL THICKNESS parameter was selected on the *BEAM SECTION, *SHELL SECTION or *SOLID SECTION card. Right now, it cannot be used for composite materials.

For structures in which axisymmetric elements (type CAX*) are present any thickness defined on the present card for plane stress/strain and shell elements applies to 360°.

First line:

- *NODAL THICKNESS

Following line:

- Node or set of nodes previously defined
- Thickness 1
- Thickness 2

Example:

```
*NODAL THICKNESS
22,0.05,0.08
```

assigns to node 22 the thickness 0.05 and 0.08. Any plane stress or shell element containing node 22 will have a local thickness of 0.05 unit lengths at node 22. Any beam element containing node 22 will have a thickness of 0.05 unit length in local 1-direction and a thickness of 0.08 unit length in local 2-direction.

Example files: shell1.

7.95 *NODE

Keyword type: model definition

This option allows nodes and their coordinates to be defined. The parameter NSET is optional and is used to assign the nodes to a node set. If the set already exists, the nodes are ADDED to the set.

First line:

- *NODE
- Enter the optional parameter, if desired.

Following line:

- node number.
- Value of the first global rectangular coordinate.
- Value of the second global rectangular coordinate.
- Value of the third global rectangular coordinate.

Repeat this line if needed.

Example:

```
*NODE,NSET=Na11
1,0.,0.,0.
2,1.,0.,0.
3,0.,1.,0.
```

defines three nodes with node number one, two and three and rectangular coordinates (0.,0.,0.), (1.,0.,0.) and (0.,1.,0.) respectively.

Example files: beam8t, beamb, beamdy1.

7.96 *NODE FILE

Keyword type: step

This option is used to print selected nodal variables in file jobname.frd for subsequent viewing by CalculiX GraphiX. The following variables can be selected (the label is square brackets [] is the one used in the .frd file; for frequency calculations with cyclic symmetry both a real and an imaginary part may be stored, in all other cases only the real part is stored):

- CP [CP3DF]: Pressure coefficient in 3D compressible fluids.
- DEPF [DISP]: Vector denoting the change in fluid depth compared to the reference depth in 3D shallow water calculations.
- DEPT [DEPTH]: Fluid depth (in the direction of the gravity vector) in channel networks.
- DTF [DTIMF]: Fluid time increment in 3D fluids.
- HCRI [HCRT]: Critical depth in channel networks.
- KEQ [CT3D-MIS]: Equivalent stress intensity factor and related quantities in crack propagation calculations.
- MACH [M3DF]: Mach numbers in 3D compressible fluids.
- MAXU [MDISP]: Maximum displacements orthogonal to a given vector at all times for *FREQUENCY calculations with cyclic symmetry. The components of the vector are the coordinates of a node stored in a node set with the name RAY. This node and node set must have been defined by the user.
- MF [MAFLOW]: Mass flows in networks. The mass flow through a network element is stored in the middle node of the element. In the end nodes the mass flow is not unique, since more than two element can be connected to the node. For end nodes the sum of the mass flow leaving the node is stored. Notice that at nodes where mass flow is leaving the network the value will be wrong if no proper exit element (with node number 0) is attached to that node.
- NT [NDTEMP]: Temperatures. This includes both structural temperatures and total fluid temperatures in a network.
- PNT [PNDTEMP]: Temperatures: magnitude and phase (only for *STEADY STATE DYNAMICS calculations).
- POT [ELPOT]: Electrical potential, only for electromagnetic calculations.
- PRF [PFORC]: External forces: magnitude and phase (only for *FREQUENCY calculations with cyclic symmetry).

- PS [STPRES]: Static pressures in liquid networks.
- PSF [PS3DF]: Static pressures in 3D fluids.
- PT [TOPRES]: Total pressures in gas networks.
- PTF [PT3DF]: Total pressures in 3D fluids.
- PU [PDISP]: Displacements: magnitude and phase (only for *STEADY STATE DYNAMICS calculations and *FREQUENCY calculations with cyclic symmetry).
- RF [FORC(real), FORCI(imaginary)]: External forces (only static forces; dynamic forces, such as those caused by dashpots, are not included)
- RFL [RFL]: External concentrated heat sources.
- SEN [SEN]: Sensitivities.
- TS [STTEMP]: Static temperatures in networks.
- TSF [TS3DF]: Static temperatures in 3D fluids.
- TT [TOTEMP]: Total temperatures in networks.
- TTF [TT3DF]: Total temperatures in 3D fluids.
- TURB [TURB3DF]: Turbulence variables in 3D fluids: ρk , $\rho\omega$, ν_t , y^+ and u^+ .
- U [DISP(real), DISPI(imaginary)]: Displacements.
- V [VELO]: Velocities in dynamic calculations.
- VF [V3DF]: Velocities in 3D fluids.

The selected variables are stored for the complete model.

The external forces (key RF) are the sum of the reaction forces, concentrated loads (*CLOAD) and distributed loads (*DLOAD) in the node at stake. Only in the absence of concentrated loads in the node and distributed loads in any element to which the node belongs, the external forces reduce to the reaction forces. Forces induced by multiple point constraints are not calculated. Since single point constraints defined in transformed coordinates are converted into multiple point constraints in the global rectangular system, the force in a node in which a SPC is defined in local coordinates are not correctly delivered upon using the RF key in combination with the *NODE PRINT keyword card.

For frequency calculations with cyclic symmetry the eigenmodes are generated in pairs (different by a phase shift of 90 degrees). Only the first one of each pair is stored in the frd file. If U is selected (the displacements) two load cases are stored in the frd file: a loadcase labeled DISP containing the real part of the displacements and a loadcase labeled DISPI containing the imaginary part of the displacements. For all other variables only the real part is stored.

The first occurrence of an *NODE FILE keyword card within a step wipes out all previous nodal variable selections for file output. If no *NODE FILE card is used within a step the selections of the previous step apply. If there is no previous step, no nodal variables will be stored.

Notice that only values in nodes belonging to elements are stored. Values in nodes not belonging to any element (e.g. the rotational node in a *RIGID BODY option) can only be obtained using *NODE PRINT.

There are nine optional parameters: FREQUENCY, FREQUENCYF, GLOBAL, OUTPUT, OUTPUT ALL, TIME POINTS, NSET, LAST ITERATIONS and CONTACT ELEMENTS. The parameters FREQUENCY and TIME POINTS are mutually exclusive.

FREQUENCY applies to nonlinear calculations where a step can consist of several increments. Default is FREQUENCY=1, which indicates that the results of all increments will be stored. FREQUENCY=N with N an integer indicates that the results of every Nth increment will be stored. The final results of a step are always stored. If you only want the final results, choose N very big. The value of N applies to *OUTPUT,*ELEMENT OUTPUT, *EL FILE, *ELPRINT, *NODE OUTPUT, *NODE FILE, *NODE PRINT, *SECTION PRINT,*CONTACT OUT, *CONTACT FILE and *CONTACT PRINT. If the FREQUENCY parameter is used for more than one of these keywords with conflicting values of N, the last value applies to all. A frequency parameter stays active across several steps until it is overwritten by another FREQUENCY value or the TIME POINTS parameter.

The 3D fluid analogue of FREQUENCY is FREQUENCYF. In coupled calculations FREQUENCY applies to the thermomechanical output, FREQUENCYF to the 3D fluid output.

With the parameter GLOBAL you tell the program whether you would like the results in the global rectangular coordinate system or in the local nodal system. If an *TRANSFORM card is applied to the node at stake, this card defines the local system. If no *TRANSFORM card is applied to the element, the local system coincides with the global rectangular system. Default value for the GLOBAL parameter is GLOBAL=YES, which means that the results are stored in the global system. If you prefer the results in the local system, specify GLOBAL=NO.

The parameter OUTPUT can take the value 2D or 3D. This has only effect for 1d and 2d elements such as beams, shells, plane stress, plane strain and axisymmetric elements AND provided it is used in the first step. If OUTPUT=3D, the 1d and 2d elements are stored in their expanded three-dimensional form. In particular, the user has the advantage to see his/her 1d/2d elements with their real thickness dimensions. However, the node numbers are new and do not relate to the node numbers in the input deck. Once selected, this parameter is active in the complete calculation. If OUTPUT=2D the fields in the expanded elements are averaged to obtain the values in the nodes of the original 1d and 2d elements. In particular, averaging removes the bending stresses in beams and shells. Therefore, default for beams and shells is OUTPUT=3D, for plane stress, plane strain and axisymmetric elements it is OUTPUT=2D. For axisym-

metric structures and OUTPUT=2D the mass flow (MF) and the external force (RF) are stored for 360°, else it is stored for the displayed 3D segment, i.e. 2°. If OUTPUT=3D is selected, the parameter NSET is deactivated.

The parameter OUTPUT ALL specifies that the data has to be stored for all nodes, including those belonging to elements which have been deactivated. Default is storage for nodes belonging to active elements only.

With the parameter TIME POINTS a time point sequence can be referenced, defined by a *TIME POINTS keyword. In that case, output will be provided for all time points of the sequence within the step and additionally at the end of the step. No other output will be stored and the FREQUENCY parameter is not taken into account. Within a step only one time point sequence can be active. If more than one is specified, the last one defined on any of the keyword cards *NODE FILE, *EL FILE, *NODE PRINT or *EL PRINT will be active. The TIME POINTS option should not be used together with the DIRECT option on the procedure card. The TIME POINTS parameters stays active across several steps until it is replaced by another TIME POINTS value or the FREQUENCY parameter.

The specification of a node set with the parameter NSET limits the output to the nodes contained in the set. For cyclic symmetric structures the usage of the parameter NGRAPH on the *CYCLIC SYMMETRY MODEL card leads to output of the results not only for the node set specified by the user (which naturally belongs to the base sector) but also for all corresponding nodes of the sectors generated by the NGRAPH parameter. Notice that for cyclic symmetric structures the use of NSET is mandatory.

The parameter LAST ITERATIONS leads to the storage of the displacements in all iterations of the last increment in a file with name ResultsForLastIterations.frd (can be opened with CalculiX GraphiX). This is useful for debugging purposes in case of divergence. No such file is created if this parameter is absent.

Finally, the parameter CONTACT ELEMENTS stores the contact elements which have been generated in each iteration in a file with the name jobname.cel. When opening the frd file with CalculiX GraphiX these files can be read with the command “read jobname.cel inp” and visualized by plotting the elements in the sets contactelements_st α _in β _at γ _it δ , where α is the step number, β the increment number, γ the attempt number and δ the iteration number.

First line:

- *NODE FILE
- Enter any needed parameters and their values.

Second line:

- Identifying keys for the variables to be printed, separated by commas.

Example:

```
*NODE FILE,TIME POINTS=T1
RF,NT
```

requests the storage of reaction forces and temperatures in the .frd file for all time points defined by the T1 time points sequence.

Example files: beampt, beamp01.

7.97 *NODE OUTPUT

Keyword type: step

This option is used to print selected nodal variables in file jobname.frd for subsequent viewing by CalculiX GraphiX. The options and its use are identical with the *NODE FILE keyword, however, the resulting .frd file is a mixture of binary and ASCII (the .frd file generated by using *NODE FILE is completely ASCII). This has the advantage that the file is smaller and can be faster read by cgx.

If FILE and OUTPUT cards are mixed within one and the same step the last such card will determine whether the .frd file is completely in ASCII or a mixture of binary and ASCII.

Example:

```
*NODE OUTPUT,FREQUENCY=2,TIME POINTS=T1
RF,NT
```

requests the storage of reaction forces and temperatures in the .frd file every second increment. In addition, output will be stored for all time points defined by the T1 time points sequence.

Example files: cubespring.

7.98 *NODE PRINT

Keyword type: step

This option is used to print selected nodal variables in file jobname.dat. The following variables can be selected:

- Displacements (key=U)
- Structural temperatures and total temperatures in networks (key=NT or TS; both are equivalent)
- Static temperatures in 3D fluids (key=TSF)
- Total temperatures in 3D fluids (key=TTF)

- Pressures in networks (key=PN). These are the total pressures for gases, static pressures for liquids and liquid depth for channels. The fluid section types dictate the kind of network.
- Static pressures in 3D fluids (key=PSF)
- Total pressures in 3D fluids (key=PTF)
- Mach numbers in compressible 3D fluids (key=MACH)
- Pressure coefficients in compressible 3D fluids (key=CP)
- Velocities in 3D fluids (key=VF)
- Fluid depth in 3D shallow water calculations (key=DEPF)
- Turbulent parameters in 3D fluids (key=TURB)
- Mass flows in networks (key=MF)
- External forces (key=RF) (only static forces; dynamic forces, such as those caused by dashpots, are not included)
- External concentrated heat sources (key=RFL)

The external forces are the sum of the reaction forces, concentrated loads (*CLOAD) and distributed loads (*DLOAD) in the node at stake. Only in the absence of concentrated loads in the node and distributed loads in any element to which the node belongs, the external forces reduce to the reaction forces. Forces induced by multiple point constraints are not calculated. Since single point constraints defined in transformed coordinates are converted into multiple point constraints in the global rectangular system, the force in a node in which a SPC is defined in local coordinates are not correctly delivered upon using the RF key in combination with the *NODE PRINT keyword card.

There are six parameters, FREQUENCY, FREQUENCYF, NSET, TOTALS, GLOBAL and TIME POINTS. The parameter NSET is required, defining the set of nodes for which the displacements should be printed. If this card is omitted, no values are printed. Several *NODE PRINT cards can be used within one and the same step.

The parameters FREQUENCY and TIME POINTS are mutually exclusive.

The parameter FREQUENCY is optional, and applies to nonlinear calculations where a step can consist of several increments. Default is FREQUENCY=1, which indicates that the results of all increments will be stored. FREQUENCY=N with N an integer indicates that the results of every Nth increment will be stored. The final results of a step are always stored. If you only want the final results, choose N very big. The value of N applies to *OUTPUT, *ELEMENT OUTPUT, *EL FILE, *ELPRINT, *NODE OUTPUT, *NODE FILE, *NODE PRINT, *SECTION PRINT, *CONTACT OUTPUT, *CONTACT FILE and *CONTACT PRINT. If the FREQUENCY parameter is used for more than

one of these keywords with conflicting values of N, the last value applies to all. A frequency parameter stays active across several steps until it is overwritten by another FREQUENCY value or the TIME POINTS parameter.

The 3D fluid analogue of FREQUENCY is FREQUENCYF. In coupled calculations FREQUENCY applies to the thermomechanical output, FREQUENCYF to the 3D fluid output.

The parameter TOTALS only applies to external forces. If TOTALS=YES the sum of the external forces for the whole node set is printed in addition to their value for each node in the set separately. If TOTALS=ONLY is selected the sum is printed but the individual nodal contributions are not. If TOTALS=NO (default) the individual contributions are printed, but their sum is not. Notice that the sum is always written in the global rectangular system, irrespective of the value of the GLOBAL parameter.

With the optional parameter GLOBAL you tell the program whether you would like the results in the global rectangular coordinate system or in the local nodal system. If an *TRANSFORM card is applied to the node at stake, this card defines the local system. If no *TRANSFORM card is applied to the element, the local system coincides with the global rectangular system. Default value for the GLOBAL parameter is GLOBAL=NO, which means that the results are stored in the local system. If you prefer the results in the global system, specify GLOBAL=YES. If the results are stored in the local system the character 'L' is listed at the end of the line.

With the parameter TIME POINTS a time point sequence can be referenced, defined by a *TIME POINTS keyword. In that case, output will be provided for all time points of the sequence within the step and additionally at the end of the step. No other output will be stored and the FREQUENCY parameter is not taken into account. Within a step only one time point sequence can be active. If more than one is specified, the last one defined on any of the keyword cards *NODE FILE, *EL FILE, *NODE PRINT, *EL PRINT or *FACE PRINT will be active. The TIME POINTS option should not be used together with the DIRECT option on the procedure card. The TIME POINTS parameters stays active across several steps until it is replaced by another TIME POINTS value or the FREQUENCY parameter.

The first occurrence of an *NODE PRINT keyword card within a step wipes out all previous nodal variable selections for print output. If no *NODE PRINT card is used within a step the selections of the previous step apply, if any.

Notice that some of the keys apply to specific domains. For instance, PS and V can only be used for 3D fluids, PT and MF only for networks. Furthermore, PT only makes sense for the vertex nodes of the network elements, whereas MF only applies to the middle nodes of network elements. It is the responsibility of the user to make sure that the sets (s)he specifies contain the right nodes. For nodes not matching the key the printed values are meaningless. If the model contains axisymmetric elements the mass flow applies to a segment of 2°. So for the total flow this value has to be multiplied by 180.

First line:

- *NODE PRINT
- Enter the parameter NSET and its value.

Second line:

- Identifying keys for the variables to be printed, separated by commas.

Example:

```
*NODE PRINT,NSET=N1  
RF
```

requests the storage of the reaction forces in the nodes belonging to (node) set N1 in the .dat file.

Example files: beampkin, beamrb.

7.99 *NORMAL

Keyword type: model definition

With this option a normal can be defined for a (node,element) pair. This only makes sense for shell elements and beam elements. For beam elements the normal direction is the local 2-direction. If no normal is specified in a node it is calculated on basis of the local geometry. If the normal defined by the user has not unit length, it will be normalized. There are no parameters for this keyword card.

First line:

- *NORMAL
- Element number
- Node number
- Global x-coordinate of the normal
- Global y-coordinate of the normal
- Global z-coordinate of the normal

Example:

```
*NORMAL  
5,18,0.707,0.,0.707
```

Defines a normal with components (0.707,0.,0.707) in node 18 of element 5.

Example files: shellnor.

7.100 *NSET

Keyword type: model definition

This option is used to assign nodes to a node set. The parameter NSET containing the name of the set is required (maximum 80 characters), whereas the parameter GENERATE (without value) is optional. If present, nodal ranges can be expressed by their initial value, their final value, and an increment. If a set with the same name already exists, it is reopened and complemented. The name of a set is case insensitive. Internally, it is modified into upper case and a 'N' is appended to denote it as node set. Nodes are internally stored in the order they are entered, no sorting is performed.

The following names are reserved (i.e. cannot be used by the user for other purposes than those for which they are reserved):

- RAY: node set needed by MAXU (cf. *NODE FILE).
- STRESSDOMAIN: node set needed by MAXS (cf. *EL FILE).
- STRAINDOMAIN: node set needed by MAXE (cf. *EL FILE).
- SOLIDSURFACE: node set needed for turbulent CFD-CBS calculations.
- FREESTREAMSURFACE: node set needed for turbulent CFD-CBS calculation.

First line:

- *NSET
- Enter any needed parameters and their values.

Following line if the GENERATE parameter is omitted:

- List of nodes and/or sets of nodes previously defined to be assigned to this node set (maximum 16 entries per line).

Repeat this line if needed.

Following line if the GENERATE parameter is included:

- First node in set.
- Last node in set.
- Increment in nodal numbers between nodes in the set. Default is 1.

Repeat this line if needed.

Example:

```
*NSET,NSET=N1
1,8,831,208
*NSET,NSET=N2
100,N1
```

assigns the nodes with number 1, 8, 831 and 208 to (node) set N1 and the nodes with numbers 1, 8, 831, 208 (= set N1) and 100 to set N2.

Example files: segmentm, shell2.

7.101 *OBJECTIVE

Keyword type: step

With *OBJECTIVE one can define the objective function for which a feasible direction shall be computed in a *FEASIBLE DIRECTION step. The feasible direction is basically the sensitivity of a design response function defined as objective, possibly corrected by design responses defined as constraints and/or geometric constraints. Right now, the calculation of a feasible direction can only be done for TYPE=COORDINATE design variables. The objective function can be any design response function defined in a previous *SENSITIVITY step. It is referred to by using its name given on the *DESIGN RESPONSE line.

There is one optional parameter TARGET. If TARGET=MIN (= default) the sensitivity is calculated for a minimization of the objective, if TARGET=MAX for a maximization. The difference comes into play when determining which constraints are active. Exactly one *OBJECTIVE keyword is required in a *FEASIBLE DIRECTION step. This keyword has to be followed by exactly one design response name.

First line:

- *OBJECTIVE.
- the parameter target, if needed.

Second line:

- name of a design response

Example:

```
*OBJECTIVE
DR1
```

defines the design response with name DR1 as the objective.

Example files: opt1, opt3.

7.102 *ORIENTATION

Keyword type: model definition

This option may be used to specify a local axis system X'-Y'-Z' to be used for defining material properties. For now, rectangular and cylindrical systems can

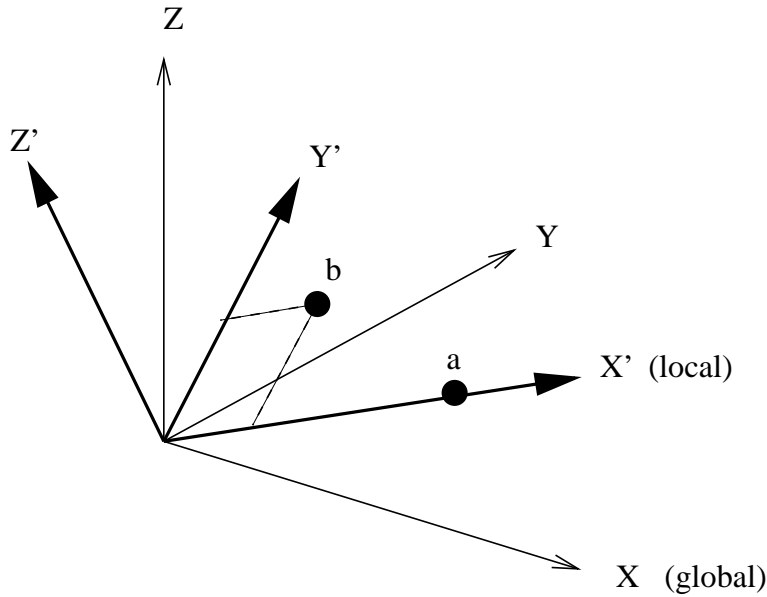

Figure 162: Definition of a rectangular coordinate system

be defined, triggered by the parameter `SYSTEM=RECTANGULAR` (default) and `SYSTEM=CYLINDRICAL`.

A rectangular system is defined by specifying a point `a` on the local `X'` axis and a point `b` belonging to the `X'-Y'` plane but not on the `X'` axis. A right hand system is assumed (Figure 162).

When using a cylindrical system two points `a` and `b` on the axis must be given. The `X'` axis is in radial direction, the `Z'` axis in axial direction from point `a` to point `b`, and `Y'` is in tangential direction such that `X'-Y'-Z'` is a right hand system (Figure 163).

Instead of listing the coordinates of points `a` and `b` explicitly on the line underneath `*ORIENTATION`, the user can specify a distribution defined by a `*DISTRIBUTION` card.

The parameter `NAME`, specifying a name for the orientation so that it can be used in an element property definition (e.g. `*SOLID SECTION`) is required (maximum 80 characters).

Notice that a shell ALWAYS induces a local element coordinate system, independent of whether an `*ORIENTATION` applies or not. For details the user is referred to Section 6.2.14.

For rectangular systems an additional rotation about one of the local axes can be specified on the second line underneath the `*ORIENTATION` card.

First line:

- `*ORIENTATION`

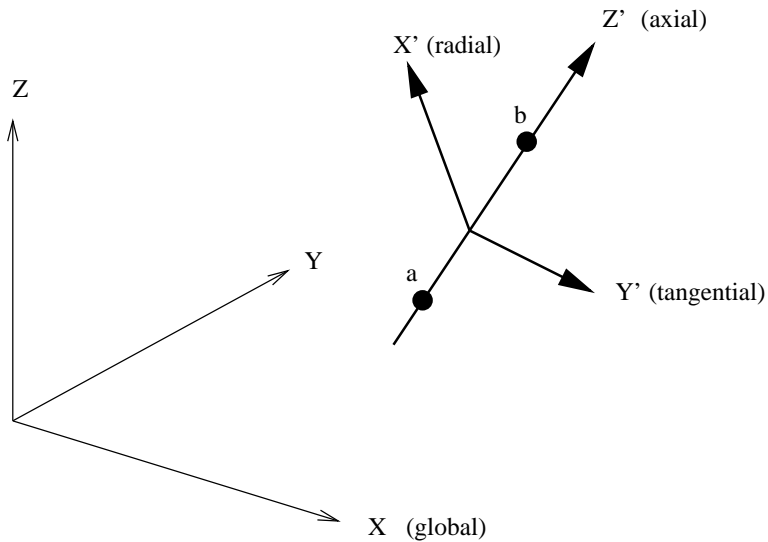

Figure 163: Definition of a cylindrical coordinate system

- Enter the required parameter NAME, and the optional parameter SYSTEM if needed.

Second line (explicit definition of a and b):

- X-coordinate of point a.
- Y-coordinate of point a.
- Z-coordinate of point a.
- X-coordinate of point b.
- Y-coordinate of point b.
- Z-coordinate of point b.

Second line (use of a distribution):

- name of the distribution.

Third line (optional for local rectangular systems)

- local axis about which an additional rotation is to be performed (1=local x-axis, 2=local y-axis, 3=local z-axis).
- angle of rotation in degrees.

Example:

```
*ORIENTATION,NAME=OR1,SYSTEM=CYLINDRICAL
0.,0.,0.,1.,0.,0.
```

defines a cylindrical coordinate system with name OR1 and axis through the points (0.,0.,0.) and (1.,0.,0.). Thus, the x-axis in the global coordinate system is the axial direction in the cylindrical system.

Example files: beampo2,beampo6.

7.103 *OUTPUT

Keyword type: model definition

This keyword is provided for compatibility with ABAQUS. The only parameters are FREQUENCY and FREQUENCYF. They are optional.

The parameter FREQUENCY applies to nonlinear calculations where a step can consist of several increments. Default is FREQUENCY=1, which indicates that the results of all increments will be stored. FREQUENCY=N with N an integer indicates that the results of every Nth increment will be stored. The final results of a step are always stored. If you only want the final results, choose N very big. The value of N applies to *OUTPUT,*ELEMENT OUTPUT,*EL FILE,*ELPRINT,*NODE OUTPUT,*NODE FILE,*NODE PRINT,*SECTION PRINT,*CONTACT FILE and *CONTACT PRINT. If the FREQUENCY parameter is used for more than one of these keywords with conflicting values of N, the last value applies to all. A frequency parameter stays active across several steps until it is overwritten by another FREQUENCY value or the TIME POINTS parameter.

The 3D fluid analogue of FREQUENCY is FREQUENCYF. In coupled calculations FREQUENCY applies to the thermomechanical output, FREQUENCYF to the 3D fluid output.

7.104 *PHYSICAL CONSTANTS

Keyword type: model definition

This keyword is used to define the Stefan–Boltzmann constant, absolute zero temperature and the universal gravitational constant in the user’s units. For 3D fluid calculations only absolute zero temperature is needed, for radiation type boundary conditions both absolute zero temperature and the Stefan–Boltzmann constant must be defined. They are defined by the two parameters ABSOLUTE ZERO and STEFAN BOLTZMANN. The universal gravitational constant is required for general gravitational loading, e.g. for the calculation of orbits and is defined by the parameter NEWTON GRAVITATION.

First line:

- *PHYSICAL CONSTANTS

Example:

```
*PHYSICAL CONSTANTS, ABSOLUTE ZERO=0, STEFAN BOLTZMANN=5.669E-8
```

for time in s, length in m, mass in kg and temperature in K (unit of the Stefan-Boltzmann constant: $Wm^{-2}K^{-4}$).

Example:

```
*PHYSICAL CONSTANTS, NEWTON GRAVITY=6.67E-11
```

for time in s, length in m, mass in kg and temperature in K (unit of the universal gravitational constant: Nm^2kg^{-2}).

Example files: beamhtbf, oneel20cf, cubenewt.

7.105 *PLASTIC

Keyword type: model definition, material

This option is used to define the plastic properties of an incrementally plastic material. There is one optional parameter HARDENING. Default is HARDENING=ISOTROPIC, other values are HARDENING=KINEMATIC for kinematic hardening, HARDENING=COMBINED for combined isotropic and kinematic hardening HARDENING=USER for user defined hardening curves and HARDENING=JOHNSON COOK for Johnson-Cook hardening [40], cf. Section 6.8.10. All constants may be temperature dependent. The card should be preceded by a *ELASTIC card within the same material definition, defining the elastic properties of the material. User defined hardening curves should be defined in the user subroutine uhardening.f

For Johnson-Cook hardening the temperature dependence is included in the model equations. However, it may be deactivated by setting the transition temperature equal to the melt temperature. For Johnson-Cook hardening the material must be isotropic and a *RATE DEPENDENT card must be used to define the rate dependence of the hardening curve.

For all other hardening types different rules apply. If the elastic data is isotropic, the large strain viscoplastic theory treated in [89] and [90] is applied if the NLGEOM parameter is active on the *STEP card, else the linear theory from Section 6.8.9 is used. If the elastic data is orthotropic, the infinitesimal strain model discussed in Section 6.8.16 is used. Accordingly, for an elastically orthotropic material the hardening can be at most linear. Furthermore, if the temperature data points for the hardening curves do not correspond to the *ELASTIC temperature data points, they are interpolated at the latter points. Accordingly, for an elastically orthotropic material, it is advisable to define the hardening curves at the same temperatures as the elastic data.

For the selection of plastic output variables the reader is referred to Section 6.8.8.

First line:

- *PLASTIC

- Enter the HARDENING parameter and its value, if needed

Following sets of lines define the isotropic hardening curve for HARDENING=ISOTROPIC and the kinematic hardening curve for HARDENING=KINEMATIC or HARDENING=COMBINED: First line in the first set:

- Von Mises stress.
- Equivalent plastic strain.
- Temperature.

Use as many lines in the first set as needed to define the complete hardening curve for this temperature.

Use as many sets as needed to define complete temperature dependence.

For the definition of the isotropic hardening curve for HARDENING=COMBINED the keyword *CYCLIC HARDENING is used.

For Johnson-Cook hardening the model constants are to be entered in the following order:

- A.
- B.
- n (> 0).
- m (> 0).
- T_m (melt temperature).
- T_0 (transition temperature).

Example:

```
*PLASTIC
800.,0.,273.
900.,0.05,273.
1000.,0.15,273.
700.,0.,873.
750.,0.04,873.
800.,0.13,873.
```

defines two stress-strain curves: one for temperature $T=273$. and one for $T=873$. The curve at $T=273$ connects the points (800.,0.), (900.,0.05) and (1000.,0.15), the curve at $T=873$ connects (700.,0.), (750.,0.04) and (800.,0.13). Notice that the first point on the curves represents first yielding and must give the Von Mises stress for a zero equivalent plastic strain.

Example files: beampd, beampiso, beampkin, beamppt.

7.106 *PRE-TENSION SECTION

Keyword type: model definition

This option is used to define a pre-tension in a bolt or similar structure. There are three parameters: SURFACE, ELEMENT and NODE. The parameter NODE is required as well as one of the parameters SURFACE and ELEMENT. The latter two parameters are mutually exclusive.

With the parameter SURFACE an element face surface can be defined on which the pre-tension acts. This is usually a cross section of the bolt. This option is used for volumetric elements. Alternatively, the bolt can be modeled with just one linear beam element (type B31). In that case the parameter ELEMENT is required pointing to the number of the beam element.

The parameter NODE is used to define a reference node. This node should not be used elsewhere in the model. In particular, it should not belong to any element. The coordinates of this node are immaterial. The first degree of freedom of this node is used to define a pre-tension force with *CLOAD or a differential displacement with *BOUNDARY. The force and the displacements are applied in the direction of a vector, which is the normal to the surface if the SURFACE parameter is used and the axis of the beam element if the ELEMENT parameter is used. This vector can be defined underneath the *PRE-TENSION SECTION keyword. If the vector is specified away from the elements whose faces belong to the surface (volumetric case) or in the direction going from node 1 to node 2 in the element definition (for the beam element), a positive force or positive displacements correspond to tension in the underlying structure. If no such vector is defined by the user, it is calculated automatically as the mean of the normals away from the elements whose faces belong to the surface (volumetric case) or as the vector extending from node 1 to node 2 (beam case).

Notice that in the volumetric case the surface must be defined by element faces, it cannot be defined by nodes. Furthermore, the user should make sure that

- the surface does not contain edges or vertices of elements which do not have a face in common with the surface. Transgression of this rule will lead to unrealistic stress concentrations.
- the surface is not adjacent to quadratic elements the faces of which belong to a contact surface.

Internally, the nodes belonging to the element face surface are copied and a linear multiple point constraint is generated between the nodes expressing that the mean force is the force specified by the user (or similarly, the mean differential displacement is the one specified by the user). Therefore, if the user visualizes the results with CalculiX GraphiX, a gap will be noticed at the location of the pre-tension section.

For beam elements a linear multiple point constraint is created between the nodes belonging to the beam element. The beam element itself is deleted, i.e. it will not show up in the frd-file. Therefore, no other boundary conditions or

loads can be applied to such elements. Their only reason of existence is to create an easy means in which the user can define a pretension. To this end the nodes of the beam element (e.g. representing a bolt) should be connected by linear equations or a *DISTRIBUTING COUPLING card to nodes of the structures to be held together.

First line:

- *PRE-TENSION SECTION
- Enter the NODE and the SURFACE or ELEMENT parameter and their values

Following line (optional):

- First component in global coordinates of the normal on the surface
- Second component in global coordinates of the normal on the surface
- Third component in global coordinates of the normal on the surface

Example:

```
*PRE-TENSION SECTION,SURFACE=SURF1,NODE=234
1.,0.,0.
```

defines a pre-tension section consisting of the surface with the name SURF1 and reference node 234. The normal on the surface is defined as the positive global x-direction.

Example files: pret1, pret2, pret3.

7.107 *RADIATE

Keyword type: step

This option allows the specification of radiation heat transfer of a surface at absolute temperature θ (i.e. in Kelvin) and with emissivity ϵ to the environment at absolute temperature θ_0 . The environmental temperature θ_0 is also called the sink temperature. If the user wishes so, it can be calculated by cavity radiation considerations from the temperatures of other visible surfaces. The radiation heat flux q satisfies:

$$q = \epsilon\sigma(\theta^4 - \theta_0^4), \quad (882)$$

where $\sigma = 5.67 \times 10^{-8} W/m^2 K^4$ is the Stefan-Boltzmann constant. The emissivity takes values between 0 and 1. Blackbody radiation is characterized by $\epsilon = 1$. In CalculiX, the radiation is assumed to be diffuse (it does not depend on the angle under which it is emitted from the surface) and gray (it does not depend on the wavelength of the radiation). Selecting radiation type flux

requires the inclusion of the *PHYSICAL CONSTANTS card, which specifies the value of the Stefan–Boltzmann constant and the value of absolute zero in the user's units. In order to specify which face the flux is entering or leaving the faces are numbered. The numbering depends on the element type.

For hexahedral elements the faces are numbered as follows (numbers are node numbers):

- Face 1: 1-2-3-4
- Face 2: 5-8-7-6
- Face 3: 1-5-6-2
- Face 4: 2-6-7-3
- Face 5: 3-7-8-4
- Face 6: 4-8-5-1

for tetrahedral elements:

- Face 1: 1-2-3
- Face 2: 1-4-2
- Face 3: 2-4-3
- Face 4: 3-4-1

and for wedge elements:

- Face 1: 1-2-3
- Face 2: 4-5-6
- Face 3: 1-2-5-4
- Face 4: 2-3-6-5
- Face 5: 3-1-4-6

for quadrilateral plane stress, plane strain and axisymmetric elements:

- Face 1: 1-2
- Face 2: 2-3
- Face 3: 3-4
- Face 4: 4-1
- Face N: in negative normal direction (only for plane stress)
- Face P: in positive normal direction (only for plane stress)

for triangular plane stress, plane strain and axisymmetric elements:

- Face 1: 1-2
- Face 2: 2-3
- Face 3: 3-1
- Face N: in negative normal direction (only for plane stress)
- Face P: in positive normal direction (only for plane stress)

for quadrilateral shell elements:

- Face NEG or 1: in negative normal direction
- Face POS or 2: in positive normal direction
- Face 3: 1-2
- Face 4: 2-3
- Face 5: 3-4
- Face 6: 4-1

for triangular shell elements:

- Face NEG or 1: in negative normal direction
- Face POS or 2: in positive normal direction
- Face 3: 1-2
- Face 4: 2-3
- Face 5: 3-1

The labels NEG and POS can only be used for uniform, non-cavity radiation and are introduced for compatibility with ABAQUS. Notice that the labels 1 and 2 correspond to the brick face labels of the 3D expansion of the shell (Figure 69).

for beam elements:

- Face 1: in negative 1-direction
- Face 2: in positive 1-direction
- Face 3: in positive 2-direction
- Face 5: in negative 2-direction

The beam face numbers correspond to the brick face labels of the 3D expansion of the beam (Figure 74).

Radiation flux characterized by a uniform emissivity is entered by the distributed flux type label Rx where x is the number of the face, followed by the sink temperature and the emissivity. If the emissivity is nonuniform the label takes the form RxNUy and a user subroutine radiate.f must be provided specifying the value of the emissivity and the sink temperature. The label can be up to 17 characters long. In particular, y can be used to distinguish different nonuniform emissivity patterns (maximum 13 characters).

If the user does not know the sink temperature but rather prefers it to be calculated from the radiation from other surfaces, the distributed flux type label RxCR should be used (CR stands for cavity radiation). In that case, the temperature immediately following the label is considered as environment temperature for viewfactors smaller than 1, what is lacking to reach the value of one is considered to radiate towards the environment. Sometimes, it is useful to specify that the radiation is closed. This is done by specifying a value of the environment temperature which is negative if expressed on the absolute scale (Kelvin). Then, the viewfactors are scaled to one exactly. For cavity radiation the sink temperature is calculated based on the interaction of the surface at stake with all other cavity radiation surfaces (i.e. with label RyCR, y taking a value between 1 and 6). Surfaces for which no cavity radiation label is specified are not used in the calculation of the viewfactor and radiation flux. Therefore, it is generally desirable to specify cavity radiation conditions on ALL element faces (or on none). If the emissivity is nonuniform, the label reads RxCRNUy and a subroutine radiate.f specifying the emissivity must be provided. The label can be up to 17 characters long. In particular, y can be used to distinguish different nonuniform emissivity patterns (maximum 11 characters).

Optional parameters are OP, AMPLITUDE, TIME DELAY, RADIATION AMPLITUDE, RADIATION TIME DELAY, ENVNODE and CAVITY. OP takes the value NEW or MOD. OP=MOD is default and implies that the radiation fluxes on different faces are kept over all steps starting from the last perturbation step. Specifying a radiation flux on a face for which such a flux was defined in a previous step replaces this value. OP=NEW implies that all previous radiation flux is removed. If multiple *RADIATE cards are present in a step this parameter takes effect for the first *RADIATE card only.

The AMPLITUDE parameter allows for the specification of an amplitude by which the sink temperature is scaled (mainly used for dynamic calculations). Thus, in that case the sink temperature values entered on the *RADIATE card are interpreted as reference values to be multiplied with the (time dependent) amplitude value to obtain the actual value. At the end of the step the reference value is replaced by the actual value at that time. In subsequent steps this value is kept constant unless it is explicitly redefined or the amplitude is defined using TIME=TOTAL TIME in which case the amplitude keeps its validity. The AMPLITUDE parameter has no effect on nonuniform fluxes and cavity radiation.

The TIME DELAY parameter modifies the AMPLITUDE parameter. As

such, TIME DELAY must be preceded by an AMPLITUDE name. TIME DELAY is a time shift by which the AMPLITUDE definition it refers to is moved in positive time direction. For instance, a TIME DELAY of 10 means that for time t the amplitude is taken which applies to time $t-10$. The TIME DELAY parameter must only appear once on one and the same keyword card.

The RADIATION AMPLITUDE parameter allows for the specification of an amplitude by which the emissivity is scaled (mainly used for dynamic calculations). Thus, in that case the emissivity values entered on the *RADIATE card are interpreted as reference values to be multiplied with the (time dependent) amplitude value to obtain the actual value. At the end of the step the reference value is replaced by the actual value at that time. In subsequent steps this value is kept constant unless it is explicitly redefined or the amplitude is defined using TIME=TOTAL TIME in which case the amplitude keeps its validity. The RADIATION AMPLITUDE parameter has no effect on nonuniform fluxes.

The RADIATION TIME DELAY parameter modifies the RADIATION AMPLITUDE parameter. As such, RADIATION TIME DELAY must be preceded by an RADIATION AMPLITUDE name. RADIATION TIME DELAY is a time shift by which the RADIATION AMPLITUDE definition it refers to is moved in positive time direction. For instance, a RADIATION TIME DELAY of 10 means that for time t the amplitude is taken which applies to time $t-10$. The RADIATION TIME DELAY parameter must only appear once on one and the same keyword card.

The ENVNODE option allows the user to specify a sink node instead of a sink temperature. In that case, the sink temperature is defined as the temperature of the sink node.

Finally, the CAVITY parameter can be used to separate closed cavities. For the calculation of the viewfactors for a specific face, only those faces are considered which:

- are subject to cavity radiation
- belong to the same cavity.

The name of the cavity can consist of maximum 3 characters (including numbers). Default cavity is ' ' (empty name). Since the calculation of the viewfactors is approximate, it can happen that, even if a cavity is mathematically closed, radiation comes in from outside. To prevent this, one can define the faces of the cavity as belonging to one and the same cavity, distinct from the cavities other faces belong to.

Notice that in case an element set is used on any line following *RADIATE this set should not contain elements from more than one of the following groups: {plane stress, plane strain, axisymmetric elements}, {beams, trusses}, {shells, membranes}, {volumetric elements}.

In order to apply radiation conditions to a surface the element set label underneath may be replaced by a surface name. In that case the "x" in the radiation flux type label is left out.

If more than one *RADIATE card occurs in the input deck the following rules apply: if a *RADIATE applies to the same node and the same face as in a previous application then the previous value and previous amplitude (including radiation amplitude) are replaced.

First line:

- *RADIATE
- Enter any needed parameters and their value

Following line for uniform, explicit radiation conditions:

- Element number or element set label.
- Radiation flux type label (Rx).
- Sink temperature, or, if ENVNODE is active, the sink node.
- Emissivity.

Repeat this line if needed.

Following line for nonuniform, explicit radiation conditions:

- Element number or element set label.
- Radiation flux type label (RxNUy).

Repeat this line if needed.

Following line for cavity radiation conditions with uniform emissivity and uniform sink temperature:

- Element number or element set label.
- Radiation flux type label (RxCR).
- Default sink temperature, or, if ENVNODE is active, the sink node (only used if the view factors sum up to a value smaller than 1).
- Emissivity.

Repeat this line if needed.

Following line for cavity radiation conditions with nonuniform emissivity:

- Element number or element set label.
- Radiation flux type label (RxCRNUy).
- Default sink temperature, or, if ENVNODE is active, the sink node (only used if the view factors sum up to a value smaller than 1).

Repeat this line if needed.

Example:

```
*RADIATE
20,R1,273.,.5
```

assigns a radiation flux to face 1 of element 20 with an emissivity of 0.5 and a sink temperature of 273.

Example files: oneel8ra, beamhtcr.

7.108 *RATE DEPENDENT

Keyword type: model definition, material

This option is used to define the rate dependence of the yield surface according to the Johnson-Cook model (cf. Section 6.8.10). There is one required parameter TYPE=JOHNSON COOK.

First line:

- *RATE DEPENDENT
- Enter TYPE=JOHNSON COOK

Following line:

- C.
- $\dot{\epsilon}_0$ (> 0).

7.109 *REFINE MESH

Keyword type: step

With this keyword a user-defined part of the input mesh consisting of C3D4 and C3D10 elements is refined according to certain criteria and the calculation is automatically restarted with the refined mesh. Temperatures, volumetric distributed loading (e.g. centrifugal forces), point loads and single point constraints are automatically modified. This does not apply to facial distributed loads and multiple point constraints. These should not be applied to the part of the mesh to be refined. To determine the temperatures in the new mesh interpolation based on the unrefined mesh is done. For the point forces and single point constraints the definition in the unrefined mesh is kept and multiple point constraints are constructed between the concerned nodes in the old mesh and the tetrahedrons in the new mesh within which they are located.

The refinement is done in the step in which *REFINE MESH is used and is based on the results calculated in that step. The keyword should occur at most once in the complete input deck.

For the refinement the available criteria are the size of the displacements (label U), the velocity (label V), the stress (label S), the total strain (label E),

the mechanical strain (label ME), the equivalent plastic strain (label PEEQ), the energy density (label ENER), the heat flux (label HFL), the gradient based error estimator (label ERR) or a user-defined function (user subroutine ucalculateh.f). The size is defined as the absolute value if it concerns a scalar quantity and the norm if it concerns a vector or tensor.

There is one required parameter LIMIT and two optional parameters ELSESET and USER.

With the parameter LIMIT the user defines a positive value above which refinement is requested. For instance, if the limit is 50. and the value of the selected criterion is 200. a refinement by a factor of 4 is aimed at. The refinement is done iteratively (5 times), and each iteration induces a maximum refinement by a factor of 2.

The parameter ELSESET allows the user to define an element set (which should consist of C3D4 and/or C3D10 elements only) to be refined. All other elements (no matter whether tetrahedral or not) are not changed. Notice that the interface between the part of the mesh to be refined and its complement is not changed, so multiple point constraints describing this interface still work after refinement. The element set name should not be longer than 60 characters.

With the parameter USER a new criterion for the refinement can be coded in user subroutine ucalculateh.f.

If the tetrahedral mesh in the input deck contains at least one quadratic element, the refined mesh contains C3D10 elements only, else it is a pure C3D4 mesh.

First line:

- *REFINE MESH.
- enter the required parameter LIMIT and its value and any other optional parameter.

Second line:

- the label of the selected criterion.

Example:

```
*REFINE MESH,LIMIT=50.
S
```

requests a refinement based on the size of the stress and a limit of 50.

Example files: circ10p.

7.110 *RESTART

Keyword type: prestep (*RESTART,READ), step (*RESTART,WRITE)

Sometimes you wish to continue a previous run without having to redo the complete calculation. This is where the *RESTART keyword comes in. It can be used to store results for a later restart, or to continue a previous calculation.

There is one required parameter specifying whether you want to read previous results (READ) or store the results of the present calculation for future restarts (WRITE). This parameter must follow immediately after the *RESTART keyword card.

If you specify READ, you can indicate with the parameter STEP which step of the previous run is to be read. The results will be read from the binary file “jobname.rin” which should have been generated in a previous run. If the STEP parameter is absent the last step stored in the restart file is taken. A restart file can contain any number of steps and anything which is allowed within a step. For instance, one can define new loads based on sets generated in previous runs. If present, the *RESTART,READ line must be the first non-comment line in the input deck.

If you specify WRITE, you can specify the frequency (parameter FREQUENCY) at which results are stored. A frequency of two means that the results of every second step will be stored. Default is one. The results will be stored in binary format in file “jobname.rout”. Any existing file with this name will be deleted prior to the first writing operation. The restart file is being written starting with the step in which the *RESTART card appears and is being continued up to the step in which the *RESTART card is reused, if any. A reuse of the *RESTART card can be useful in case the user does not want any further steps to be stored in the restart file (FREQUENCY=0), or in case he/she wants to change the write frequency.

In order to prevent the restart file to be come too big, the user can specify the parameter OVERLAY for the *RESTART,WRITE combination. In that case every new step being written to the restart file will delete all previous information. So only the last step written to file will be available for any subsequent reuse by a *RESTART,READ command.

For a subsequent restart job with name “jobname_new.inp” the “jobname.rout” file must be renamed into “jobname_new.rin”. The *RESTART,WRITE combination must be used within a *STEP definition

First and only line:

- *RESTART
- Enter any needed parameters and their values

Example:

```
*RESTART,READ,STEP=2
```

will read the results of step two in the previous calculation.

Example:

*RESTART,WRITE,FREQUENCY=3

will write the results every third step.

Example files: beamread, beamwrite, beamread2, beamwrite2.

7.111 *RETAINED NODAL DOFS

Keyword type: step

This option is used to prescribe the nodal degrees of freedom which are kept in a *SUBSTRUCTURE GENERATE analysis. It cannot be used in any other sort of analysis.

There is one optional parameter: SORTED=NO. It is not possible to request a sorting of the degrees of freedom entered. The entries in the substructure stiffness matrix are in the order introduced by the user.

No transformation is allowed. Consequently, the global Cartesian system applies.

First line:

- *RETAINED NODAL DOFS
- Enter the parameter SORTED=NO (optional).

Following line:

- Node number or node set label
- First degree of freedom retained
- Last degree of freedom retained. This field may be left blank if only one degree of freedom is retained.

Repeat this line if needed.

Example:

```
*RETAINED NODAL DOFS
73,1,3
```

retains the degrees of freedom one through three (global) of node 73.

Example files: substructure.

7.112 *RIGID BODY

Keyword type: model definition

With this card a rigid body can be defined consisting of nodes or elements. Optional parameters are REF NODE and ROT NODE.

One of the parameters NSET or ELSET is required. Use NSET to define a rigid body consisting of the nodes belonging to a node set and ELSET for a rigid body consisting of the elements belonging to an element set. In the latter case, the rigid body really consists of the nodes belonging to the elements. The parameters NSET and ELSET are mutually exclusive. The rigid body definition ensures that the distance between any pair of nodes belonging to the body does not change during deformation. This means that the degrees of freedom are reduced to six: three translational and three rotational degrees of freedom. Thus, the motion is reduced to a translation of a reference node and a rotation about that node. Therefore, the location of the reference node is important since it is in this node that the resultant force is applied (this force may be defined by the user or may be the result of the calculation).

The reference node can be specified by the parameter REF NODE and should have been assigned coordinates using the *NODE card. The reference node can belong to the rigid body, but does not necessarily have to. Notice, however, that if the reference node belongs to the rigid body any forces requested by specifying RF on a *NODE PRINT card will not be correct. If no reference node is defined by the user the origin of the global coordinate system is taken (default).

For the rotational degrees of freedom a dummy rotational node is used whose translational degrees of freedom are interpreted as the rotations about the reference node. Thus, the first degree of freedom is used as the rotation about the x-axis of the rigid body, the second as the rotation about the y-axis and the third as the rotation about the z-axis. The rotational node can be defined explicitly using the parameter ROT NODE. In that case, this node must be given assigned coordinates (their value is irrelevant) and should not belong to any element of the structure.

In the absence of any of the parameters REF NODE or ROT NODE, extra nodes are generated internally assuming their tasks. The position of the default REF NODE is the origin. However, defining the nodes explicitly can be useful if a rotation about a specific point is to be defined (using *BOUNDARY or *CLOAD), or if rigid body values (displacements or forces) are to be printed using *NODE PRINT. Notice that a force defined in a rotational node has the meaning of a moment.

Internally, a rigid body is enforced by using nonlinear multiple point constraints (MPC).

If the participating nodes in a rigid body definition lie on a straight line, the rigid body rotation about the line is not defined and an error will occur. To remove the rotational degree of freedom, specify that the rotation about the axis is zero. If \mathbf{a} is a unit normal on the axis and \mathbf{u}_R is the displacement of the ROT NODE, this results in a linear MPC of the form $\mathbf{a} \cdot \mathbf{u}_R = 0$ to be specified

by the user by means of a *EQUATION card.

First and only line:

- *RIGID BODY
- Enter any needed parameters and their values

Example:

```
*RIGID BODY,NSET=rigid1,REF NODE=100,ROT NODE=101
```

defines a rigid body consisting of the nodes belonging to node set rigid1 with reference node 100 and rotational node 101.

Using

```
*CLOAD
101,3,0.1
```

in the same input deck (see *CLOAD) defines a moment about the z-axis of 0.1 acting on the rigid body.

Example files: beamrb.

7.113 *ROBUST DESIGN

Keyword type: step

This procedure is used to perform a robust design analysis. It is used to create random fields based on correlation and geometric tolerance information provided by the user. The only parameter RANDOM FIELD ONLY is required.

The result of a robust design analysis is a set of eigenvectors (random fields) which represent the possible fluctuation of the geometry of the structure caused by the tolerances and up to a specified accuracy. Other keywords needed in a robust design analysis are *CORRELATION LENGTH and *GEOMETRIC TOLERANCES.

First line:

- *ROBUST DESIGN
- Enter the RANDOM FIELD ONLY parameter.

Second line:

- Requested accuracy (real number; > 0. and < 1.).

Example:

```
*ROBUST DESIGN,RANDOM FIELD ONLY
0.99
```

defines a robust design analysis up to an accuracy of 99 %.

Example files: beamprand.

7.114 *SECTION PRINT

Keyword type: step

This option is used to print selected facial variables in file jobname.dat. The following variables can be selected:

- Fluid dynamic drag stresses (key=DRAG), only makes sense for 3D fluid calculations
- Heat flux (key=FLUX), only makes sense for heat calculations (structural or CFD)
- Section forces, section moments and section areas(key=SOF or key=SOM or key=SOAREA), only makes sense for structural calculations

The drag stresses are printed in the integration points of the faces. The output lists the element, the local face number, the integration point, the x-, y- and z- component of the surface stress vector in the global coordinate system, the normal component, the shear component and the global coordinates of the integration point. At the end of the listing the surface stress vectors are integrated to yield the total force on the surface.

The heat flux is also printed in the integration points of the faces. The output lists the element, the local face number, the integration point, the heat flux (positive = flux leaving the element through the surface defined by the parameter SURFACE) and the global coordinates of the integration point. At the end of the listing the heat flux vectors are integrated to yield the total heat flow through the surface.

The section forces, section moments and section areas are triggered by the keys SOF, SOM and SOAREA. All three keys are equivalent, i.e. asking for SOF (the section forces) will also trigger the calculation of the section moments and the section areas. This implementation was selected because the extra work needed to calculate the moments and areas once the forces are known is negligible. The output lists

- the components of the total surface force and moment about the origin in global coordinates
- the coordinates of the center of gravity and the components of the mean normal
- the components of the moment about the center of gravity in global coordinates
- the area, the normal force on the section (+ is tension, - is compression) and the size (absolute value) of the shear force.

Notice that, for internal surfaces (i.e. surfaces which have elements on both sides) the sign of the force and the moment depends on the side the elements of

which were selected in the definition of the *SURFACE. Please look at example beamp.inp for an illustration of this.

Since the section forces are obtained by integration of the stresses at the integration points of the faces, which are obtained by interpolation from the stress values at the facial nodes (which in turn are determined through extrapolation from the integration point values inside the volumetric elements and subsequent averaging over the elements to which the node belongs) they will not be accurate at locations where the stress jumps, such as at interfaces between different materials.

There are four parameters, SURFACE, NAME, FREQUENCYF and TIME POINTS. The parameter SURFACE is required, defining the facial surface for which the requested items are to be printed. The parameter NAME is required too, defining a name for the section print. So far, this name is not used.

The parameters FREQUENCYF and TIME POINTS are mutually exclusive.

The parameter FREQUENCYF is optional, and applies to nonlinear calculations where a step can consist of several increments. Default is FREQUENCYF=1, which indicates that the results of all increments will be stored. FREQUENCYF=N with N an integer indicates that the results of every Nth increment will be stored. The final results of a step are always stored. If you only want the final results, choose N very big. The value of N applies to *OUTPUT, *ELEMENT OUTPUT, *EL FILE, *ELPRINT, *NODE OUTPUT, *NODE FILE, *NODE PRINT, *SECTION PRINT, *CONTACT OUTPUT, *CONTACT FILE and *CONTACT PRINT. If the FREQUENCYF parameter is used for more than one of these keywords with conflicting values of N, the last value applies to all. A FREQUENCYF parameter stays active across several steps until it is overwritten by another FREQUENCYF value or the TIME POINTS parameter.

With the parameter TIME POINTS a time point sequence can be referenced, defined by a *TIME POINTS keyword. In that case, output will be provided for all time points of the sequence within the step and additionally at the end of the step. No other output will be stored and the FREQUENCYF parameter is not taken into account. Within a step only one time point sequence can be active. If more than one is specified, the last one defined on any of the keyword cards *NODE FILE, *EL FILE, *NODE PRINT or *EL PRINT will be active. The TIME POINTS option should not be used together with the DIRECT option on the procedure card. The TIME POINTS parameters stays active across several steps until it is replaced by another TIME POINTS value or the FREQUENCYF parameter.

The first occurrence of an *SECTION PRINT keyword card within a step wipes out all previous facial variable selections for print output. If no *SECTION PRINT card is used within a step the selections of the previous step apply, if any.

Several *SECTION PRINT cards can be used within one and the same step.

First line:

- *SECTION PRINT

- Enter the parameter SURFACE and its value.

Second line:

- Identifying keys for the variables to be printed, separated by commas.

Example:

```
*SECTION PRINT,SURFACE=S1,NAME=SP1
DRAG
```

requests the storage of the drag stresses for the faces belonging to (facial) set N1 in the .dat file. The name of the section print is SP1.

Example files: fluid2, beamp.

7.115 *SELECT CYCLIC SYMMETRY MODES

Keyword type: step

This option is used to trigger an eigenmode or a Green function analysis for cyclic symmetric structures. It must be preceded by a *FREQUENCY or *GREEN card, respectively. There are two optional parameters NMIN, NMAX. NMIN is the lowest cyclic symmetry mode number (also called nodal diameter) to be considered (default 0), NMAX is the highest cyclic symmetry mode number (default $N/2$ for N even and $(N+1)/2$ for N odd, where N is the number of sectors on the *CYCLIC SYMMETRY MODEL card.

For models containing the axis of cyclic symmetry (e.g. a full disk), the nodes on the symmetry axis are treated differently depending on whether the cyclic symmetry mode number is 0, 1 or exceeds 1. Therefore, for such structures calculations for cyclic symmetry mode numbers 0 or 1 must be performed in separate steps with NMIN=0,NMAX=0 and NMIN=1,NMAX=1, respectively.

First and only line:

- *SELECT CYCLIC SYMMETRY MODES
- Enter the parameters NMIN and NMAX and their values, if appropriate.

Example:

```
*SELECT CYCLIC SYMMETRY MODES, NMIN=2, NMAX=4
```

triggers a cyclic symmetry calculation for mode numbers 2 up to and including 4.

Example files: segment, fullseg, greencyc1.

7.116 *SENSITIVITY

Keyword type: step

This procedure is used to perform a sensitivity analysis. There are three optional parameters: NLGEOM, READ and WRITE. If NLGEOM is active, the change of the stiffness matrix w.r.t. the design variables is performed based on:

- a material tangent stiffness matrix at the strain at the end of the previous static step
- displacements at the end of the previous static step (large deformation stiffness)
- the stresses at the end of the previous static step (stress stiffness)

It makes sense to include NLGEOM if it was used on a previous static step and not to include it if it was not used on a previous static step or in the absence of any previous static step.

The parameters READ and WRITE are mutually exclusive and can only be used if the coordinates are the design variables. If WRITE is selected, the “raw” sensitivities (i.e. without filtering or any other action defined underneath the *FILTER card) for all design nodes are stored in file jobname.sen in ascending order of the design node numbers. If READ is selected the raw sensitivities are read from file jobname.sen. They can be further processed by filtering etc.

Notice that the objective functions STRAIN ENERGY, MASS, ALL-DISP, MISESSTRESS, PS1STRESS, PS3STRESS and EQUIVALENT PLASTIC STRAIN require a previous *STATIC step, the objective GREEN requires a previous *GREEN step and the objective EIGENFREQUENCY requires a previous *FREQUENCY step, possibly preceded by a *STATIC step, cf. *OBJECTIVE.

First line:

- *SENSITIVITY
- Enter the NLGEOM parameter if needed.

Example:

```
*SENSITIVITY
```

defines a linear sensitivity step.

Example files: beampic, beampis.

7.117 *SHELL SECTION

Keyword type: model definition

This option is used to assign material properties to shell element sets. The parameter ELSET is required, one of the mutually exclusive parameters MATERIAL and COMPOSITE is required too, whereas the parameters ORIENTATION, NODAL THICKNESS, OFFSET are optional. The parameter ELSET defines the shell element set to which the material specified by the parameter MATERIAL applies. The parameter ORIENTATION allows to assign local axes to the element set. If activated, the material properties are applied to the local axis. This is only relevant for non isotropic material behavior. The parameter NODAL THICKNESS indicates that the thickness for ALL nodes in the element set are defined with an extra *NODAL THICKNESS card and that any thicknesses defined on the *SHELL SECTION card are irrelevant. The OFFSET parameter indicates where the mid-surface of the shell should be in relation to the reference surface defined by the surface representation given by the user. The unit of the offset is the thickness of the shell. Thus, OFFSET=0 means that the reference surface is the mid-surface of the shell, OFFSET=0.5 means that the reference surface is the top surface of the shell. The offset can take any real value. Finally, the COMPOSITE parameter is used to define a composite material. It can only be used for S8R and S6 elements. A composite material consists of an integer number of layers made up of different materials with possibly different orientations. For a composite material the material is specified on the lines beneath the *SHELL SECTION card for each layer separately. The orientation for each layer can be defined in the same way. If none is specified, the orientation defined by the ORIENTATION parameter will be taken, if any.

For structures in which axisymmetric elements (type CAX*) are present any thickness defined on the present card applies to 360°.

First line:

- *SHELL SECTION
- Enter any needed parameters.

Second line if the parameter COMPOSITE is not used (the line is ignored if the first line contains NODAL THICKNESS, however, to give a value is mandatory):

- thickness

Second line if the parameter COMPOSITE is used (NODAL THICKNESS is not allowed):

- thickness (required)
- not used

- name of the material to be used for this layer (required)
- name of the orientation to be used for this layer (optional)

Repeat this line as often as needed to define all layers.

Example:

```
*SHELL SECTION,MATERIAL=EL,ELSET=Ea11,ORIENTATION=OR1,OFFSET=-0.5
3.
```

assigns material EL with orientation OR1 to all elements in (element) set Ea11. The reference surface is the bottom surface of the shell and the shell thickness is 3 length units.

Example files: shell1, shell2, shellbeam.

7.118 *SOLID SECTION

Keyword type: model definition

This option is used to assign material properties to 3D, plane stress, plane strain, axisymmetric and truss element sets. The parameters ELSET and MATERIAL are required, the parameters ORIENTATION and NODAL THICKNESS are optional. The parameter ELSET defines the element set to which the material specified by the parameter MATERIAL applies. The parameter ORIENTATION allows to assign local axes to the element set. If activated, the material properties are applied to the local axis. This is only relevant for non isotropic material behavior. The parameter NODAL THICKNESS (only relevant for plane stress and plane strain elements) indicates that the thickness for ALL nodes in the element set are defined with an extra *NODAL THICKNESS card and that any thickness defined on the *SOLID SECTION card (if any) is irrelevant. Alternatively, for plane stress and plane strain elements the element thickness can be specified on the second line. Default is 1.

For structures in which axisymmetric elements (type CAX*) are present any thickness defined on the present card applies to 360°.

First line:

- *SOLID SECTION
- Enter any needed parameters.

Second line (only relevant for plane stress, plane strain and truss elements; can be omitted for axisymmetric and 3D elements):

- thickness for plane stress and plane strain elements, cross-sectional area for truss elements.

Example:

```
*SOLID SECTION,MATERIAL=EL,ELSET=Ea11,ORIENTATION=OR1
```

assigns material EL with orientation OR1 to all elements in (element) set Eall.

Example files: beampo2, planestress, planestress4.

7.119 *SPECIFIC GAS CONSTANT

Keyword type: model definition, material

With this option the specific gas constant of a material can be defined. The specific gas constant is required for a calculation in which a gas dynamic network is included. The specific gas constant R is defined as

$$R = \mathcal{R}/M \quad (883)$$

where $\mathcal{R} = 8314 \text{ J}/(\text{kmol K})$ is the universal gas constant and M is the molecular weight of the material. The specific gas constant is temperature independent.

First line:

- *SPECIFIC GAS CONSTANT

Following line:

- Specific gas constant.

Example:

```
*SPECIFIC GAS CONSTANT
287.
```

defines a specific gas constant with a value of 287. This value is appropriate for air if Joule is chosen for the unit of energy, kg as unit of mass and K as unit of temperature, i.e. $R = 287 \text{ J}/(\text{kg K})$.

Example files: linearnet, branch1, branch2.

7.120 *SPECIFIC HEAT

Keyword type: model definition, material

With this option the specific heat of a solid material can be defined. The specific heat is required for a transient heat transfer analysis (*HEAT TRANSFER or *COUPLED TEMPERATURE-DISPLACEMENT). The specific heat can be temperature dependent.

This option should not be used to define the specific heat of a fluid (gas or liquid) in an aerodynamic or fluid dynamic network. For the latter purpose the keyword *FLUID CONSTANTS is available.

First line:

- *SPECIFIC HEAT

Following line:

- Specific heat.
- Temperature.

Repeat this line if needed to define complete temperature dependence.

Example:

```
*SPECIFIC HEAT
446.E6
```

defines a specific heat with value $446. \times 10^6$ for all temperatures.

Example files: beamth, beamhtcr.

7.121 *SPRING

Keyword type: model definition

With this option the force-displacement relationship can be defined for spring elements (cf. Sections 6.2.40,6.2.41 and 6.2.42). There is one required parameter ELSET and there are optional parameters NONLINEAR and ORIENTATION. With the parameter ELSET the element set is referred to for which the spring behavior is defined. This element set should contain spring elements only. With the parameter NONLINEAR the user can specify that the behavior of the spring is nonlinear, default is a linear behavior. Finally, the ORIENTATION parameter can be used to define a local orientation of the spring for SPRING1 and SPRING2 elements.

Please note that for a nonlinear behavior the (force,elongation) pairs have to be entered in ascending order of the elongation. The elongation is defined as the final length minus the initial length. The elongation can be negative, however, it should not be smaller than the initial length of the spring. Extrapolation in the force versus elongation graph is done in a constant way, i.e. the force is kept constant. This leads to a zero tangent and may lead to a singular stiffness matrix. Therefore, the elongation range should be defined large enough to avoid this type of problems.

For SPRING1 and SPRING2 elements the degree of freedom in which the spring acts is entered immediately underneath the *SPRING card. For a SPRINGA element this line is left blank. This is done out of compatibility reasons with

ABAQUS. Now, CalculiX deletes any blank lines before reading the input deck. Therefore, the only way for CalculiX to know whether the first line underneath the *SPRING card contains degrees of freedom or spring constant information is to inspect whether the numbers on this line are integers or reals. Therefore, for the *SPRING card the user should painstakingly take care that any real numbers (spring constant, spring force, elongation, temperature) contain a decimal point (“.”, which is a good practice anyway).

First line:

- *SPRING
- Enter the parameter ELSET and its value and any optional parameter, if needed.

Second line for SPRINGA type elements: enter a blank line

Second line for SPRING1 or SPRING2 type elements:

- first degree of freedom (integer, for SPRING1 and SPRING2 elements)
- second degree of freedom (integer, only for SPRING2 elements)

Following line if the parameter NONLINEAR is not used:

- Spring constant (real number).
- not used.
- Temperature (real number).

Repeat this line if needed to define complete temperature dependence.

Following sets of lines define the force-displacement curve if the parameter NONLINEAR is active: First line in the first set:

- Spring force (real number).
- Elongation (real number).
- Temperature (real number).

Use as many lines in the first set as needed to define the complete force-displacement curve for this temperature.

Use as many sets as needed to define complete temperature dependence.

Example:

```
*SPRING,ELSET=Ea11
blank line
10.
```

defines a linear spring constant with value 10. for all elements in element set Eall and all temperatures.

Example:

```
*SPRING,ELSET=Eall,NONLINEAR
0.,0.,293.
10.,1.,293.
100.,2.,293.
0.,0.,393.
5.,1.,393.
25.,2.,393.
```

defines a nonlinear spring characterized by a force-displacement curve through (0,0),(10,1),(100,2) for a temperature of 293. and through (0,0),(5,1),(25,2) for a temperature of 393. The first scalar in the couples is the force, the second is the elongation of the spring. This spring behavior applies to all elements in element set Eall. Notice that for displacements outside the defined range the force is kept constant. For instance, in the example above the force for an elongation of 3 at a temperature of 293 will be 100.

Example files: spring1, spring2, spring3, spring4, spring5.

7.122 *STATIC

Keyword type: step

This procedure is used to perform a static analysis. The load consists of the sum of the load of the last *STATIC step and the load specified in the present step with replacement of redefined loads.

There are five optional parameters: SOLVER, DIRECT, EXPLICIT, TIME RESET and TOTAL TIME AT START. SOLVER determines the package used to solve the ensuing system of equations. The following solvers can be selected:

- the SGI solver
- PaStiX
- PARDISO
- SPOOLES [3, 4].
- TAUCS
- the iterative solver by Rank and Ruecker [79], which is based on the algorithms by Schwarz [85].

Default is the first solver which has been installed of the following list: SGI, PaStiX, PARDISO, SPOOLES and TAUCS. If none is installed, the default is the iterative solver, which comes with the CalculiX package.

The SGI solver should by now be considered as outdated. SPOOLES is very fast, but has no out-of-core capability: the size of systems you can solve is limited by your RAM memory. With 32GB of RAM you can solve up to 1,000,000 equations. TAUCS is also good, but my experience is limited to the LL^T decomposition, which only applies to positive definite systems. It has an out-of-core capability and also offers a LU decomposition, however, I was not able to run either of them so far. PARDISO is the Intel proprietary solver and is about a factor of two faster than SPOOLES. The most recent solver we tried is the freeware solver PaStiX from INRIA. It is really fast and can use the GPU. For large problems and a high end Nvidia graphical card (32 GB of RAM) we got an acceleration of a factor between 3 and 8 compared to PARDISO. We modified PaStiX for this, therefore you have to download PaStiX from our website and compile it for your system. This can be slightly tricky, however, it is worth it!

What about the iterative solver? If SOLVER=ITERATIVE SCALING is selected, the pre-conditioning is limited to a scaling of the diagonal terms, SOLVER=ITERATIVE CHOLESKY triggers Incomplete Cholesky pre-conditioning. Cholesky pre-conditioning leads to a better convergence and maybe to shorter execution times, however, it requires additional storage roughly corresponding to the non-zeros in the matrix. If you are short of memory, diagonal scaling might be your last resort. The iterative methods perform well for truly three-dimensional structures. For instance, calculations for a hemisphere were about nine times faster with the ITERATIVE SCALING solver, and three times faster with the ITERATIVE CHOLESKY solver than with SPOOLES. For two-dimensional structures such as plates or shells, the performance might break down drastically and convergence often requires the use of Cholesky pre-conditioning. SPOOLES (and any of the other direct solvers) performs well in most situations with emphasis on slender structures but requires much more storage than the iterative solver.

The parameter DIRECT is relevant for nonlinear calculations only, and indicates that automatic incrementation should be switched off.

The parameter EXPLICIT is only important for fluid computations. If present, the fluid computation is explicit, else it is semi-implicit. Static structural computations are always implicit.

The parameter TIME RESET can be used to force the total time at the end of the present step to coincide with the total time at the end of the previous step. If there is no previous step the targeted total time is zero. If this parameter is absent the total time at the end of the present step is the total time at the end of the previous step plus the time period of the present step (2nd parameter underneath the *STATIC keyword). Consequently, if the time at the end of the previous step is 10. and the present time period is 1., the total time at the end of the present step is 11. If the TIME RESET parameter is used, the total time at the beginning of the present step is 9. and at the end of the present step it will be 10. This is sometimes useful if thermomechanical calculations are split into transient heat transfer steps followed by quasi-static static steps (this can be faster than using the *COUPLED TEMPERATURE-DISPLACEMENT option, which forces the same amount of iterations for the thermal as for the

mechanical calculations and than using the *UNCOUPLED TEMPERATURE-DISPLACEMENT option, which forces the same amount of increments for the thermal as for the mechanical calculations). In CalculiX the static step needs a finite time period, however, the user frequently does not want the quasi-static step to change the time count.

Finally, the parameter TOTAL TIME AT START can be used to set the total time at the start of the step to a specific value.

In a static step, loads are by default applied in a linear way. Other loading patterns can be defined by an *AMPLITUDE card.

If nonlinearities are present in the model (geometric nonlinearity or material nonlinearity), the solution is obtained through iteration. Since the step may be too large to obtain convergence, a subdivision of the step in increments is usually necessary. The user can define the length of the initial increment. This size is kept constant if the parameter DIRECT is selected, else it is varied by CalculiX according to the convergence properties of the solution. In a purely linear calculation the step size is always 1., no iterations are performed and, consequently, no second line underneath *STATIC is needed.

Notice that any creep behavior (e.g. by using the keyword *CREEP) is switched off in a *STATIC step. To include creep use the *VISCO keyword. The syntax for both keywords is the same.

First line:

- *STATIC
- Enter any needed parameters and their values.

Second line (only relevant for nonlinear analyses; for linear analyses, the step length is always 1)

- Initial time increment. This value will be modified due to automatic incrementation, unless the parameter DIRECT was specified (default 1.).
- Time period of the step (default 1.).
- Minimum time increment allowed. Only active if DIRECT is not specified. Default is the initial time increment or 1.e-6 times the time period of the step, whichever is smaller.
- Maximum time increment allowed. Only active if DIRECT is not specified. Default is 1.e+30.
- Initial time increment for CFD applications (default 1.e-2)

Example:

```
*STATIC,DIRECT
.1,1.
```

defines a static step and selects the SPOOLES solver as linear equation solver in the step (default). If the step is a linear one, the other parameters are of no importance. If the step is nonlinear, the second line indicates that the initial time increment is .1 and the total step time is 1. Furthermore, the parameter DIRECT leads to a fixed time increment. Thus, if successful, the calculation consists of 10 increments of length 0.1.

Example files: beampic, beampis.

7.123 *STEADY STATE DYNAMICS

Keyword type: step

This procedure is used to calculate the steady state response of a structure subject to periodic loading. Although the deformation up to the onset of the dynamic calculation can be nonlinear, this procedure is basically linear and assumes that the response can be written as a linear combination of the lowest modes of the structure. To this end, these modes must have been calculated in a previous *FREQUENCY,STORAGE=YES step (not necessarily in the same calculation; notice that if in the frequency step the parameter PERTURBATION was used on the *STEP card, PERTURBATION must also be used on the *STEP card in the steady state dynamics step). In the *STEADY STATE DYNAMICS step the eigenfrequencies, modes, stiffness and mass matrix are recovered from the file jobname.eig.

For harmonic loading the steady state response is calculated for the frequency range specified by the user. The number of data points within this range n can also be defined by the user, default is 20, minimum is 2 (if the user specifies n to be less than 2, the default is taken). If no eigenvalues occur within the specified range, this is the total number of data points taken, i.e. including the lower frequency bound and the upper frequency bound. If one or more eigenvalues fall within the specified range, $n - 2$ points are taken in between the lower frequency bound and the lowest eigenfrequency in the range, $n - 2$ between any subsequent eigenfrequencies in the range and $n - 2$ points in between the highest eigenfrequency in the range and upper frequency bound. Consequently, if m eigenfrequencies belong to the specified range, $(m+1)(n-2)+m+2 = nm-m+n$ data points are taken. They are equally spaced in between the fixed points (lower frequency bound, upper frequency bound and eigenfrequencies) if the user specifies a bias equal to 1. If a different bias is specified, the data points are concentrated about the fixed points. Default for the bias is 3., minimum value allowed is 1. (if the user specifies a value less than 1., the default is taken). The number of eigenmodes used is taken from the previous *FREQUENCY step. Since a steady state dynamics step is a perturbation step, all previous loading is removed. The loading defined within the step is multiplied by the amplitude history for each load as specified by the AMPLITUDE parameter on the loading card, if any. In this context the AMPLITUDE cards are interpreted as load factor versus frequency. Loading histories extending beyond the amplitude frequency scale are extrapolated in a constant way. The absence of the

AMPLITUDE parameter on a loading card leads to a frequency independent load.

For nonharmonic loading the loading across one period is not harmonic and has to be specified in the time domain. To this end the user can specify the starting time and the final time of one period and describe the loading within this period with *AMPLITUDE cards. Default is the interval [0., 1.] and step loading. Notice that for nonharmonic loading the *AMPLITUDE cards describe amplitude versus TIME. Furthermore, the user can specify the number of Fourier terms the nonharmonic loading is expanded in (default:20). The remaining input is the same as for harmonic loading, i.e. the user specifies a frequency range, the number of data points within this range and the bias.

There are two optional parameters: HARMONIC and SOLVER. HARMONIC=YES (default) indicates that the periodic loading is harmonic, HARMONIC=NO specifies nonharmonic periodic loading. The parameter SOLVER determines the package used to solve for the steady state solution in the presence of nonzero displacement boundary conditions. The following solvers can be selected:

- the SGI solver
- PaStiX
- PARDISO
- SPOOLES [3, 4].
- TAUCS

Default is the first solver which has been installed of the following list: SGI, PaStiX, PARDISO, SPOOLES and TAUCS. If none is installed, an error is issued.

The SGI solver should by now be considered as outdated. SPOOLES is very fast, but has no out-of-core capability: the size of systems you can solve is limited by your RAM memory. With 32GB of RAM you can solve up to 1,000,000 equations. TAUCS is also good, but my experience is limited to the LL^T decomposition, which only applies to positive definite systems. It has an out-of-core capability and also offers a LU decomposition, however, I was not able to run either of them so far. PARDISO is the Intel proprietary solver and is about a factor of two faster than SPOOLES. The most recent solver we tried is the freeware solver PaStiX from INRIA. It is really fast and can use the GPU. For large problems and a high end Nvidea graphical card (32 GB of RAM) we got an acceleration of a factor between 3 and 8 compared to PARDISO. We modified PaStiX for this, therefore you have to download PaStiX from our website and compile it for your system. This can be slightly tricky, however, it is worth it!

First line:

- *STEADY STATE DYNAMICS

- enter any of the parameters you need.

Second line for HARMONIC=YES (default):

- Lower bound of the frequency range (cycles/time)
- Upper bound of the frequency range (cycles/time)
- Number of data points n (default: 20)
- Bias (default: 3.)

Second line for HARMONIC=NO:

- Lower bound of the frequency range (cycles/time)
- Upper bound of the frequency range (cycles/time)
- Number of data points n (default: 20)
- Bias (default: 3.)
- Number of Fourier terms n (default: 20)
- Lower bound of the time range (default: 0.)
- Upper bound of the time range (default: 1.)

Example:

```
*STEADY STATE DYNAMICS
12000.,14000.,5,4.
```

defines a steady state dynamics procedure in the frequency interval [12000., 14000.] with 5 data points and a bias of 4.

Example:

```
*STEADY STATE DYNAMICS,HARMONIC=NO
2.,4.,3,1.,11,0.,.5
```

defines a steady state dynamics procedure in the time domain. A complete period is defined in the time interval [0.,0.5], and 11 Fourier terms will be taken. Calculations will be performed for three equidistant points in the frequency interval [2.,4.], i.e. for 2 cycles/time, 3 cycles/time and 4 cycles/time, provided there are no eigenfrequencies in this interval.

Example files: beamdy8, beamdy9, beamdy10, beamdy11, beamdy12, beamdy13.

7.124 *STEP

Keyword type: step

This card describes the start of a new STEP. PERTURBATION, NLGEOM, INC, INCF, THERMAL NETWORK, AMPLITUDE and SHOCK SMOOTHING are the optional parameters.

The parameter PERTURBATION is allowed for *FREQUENCY, *BUCKLE, *GREEN, *MODAL DYNAMIC, *STEADY STATE DYNAMICS, *COMPLEX FREQUENCY and *STATIC steps only (for *STATIC steps it only makes sense for submodel frequency calculations with preload, else a genuine nonlinear geometric calculation with NLGEOM is recommended).

If it is specified in a *FREQUENCY, *BUCKLE or *GREEN procedure, the last *STATIC step is taken as reference state and used to calculate the stiffness matrix. This means the inclusion of previous deformations (large deformation stiffness) and the inclusion of previous loads as preloads (stress stiffness), taking the temperatures into account to determine the material properties. The active loads (mechanical and thermal) are those specified in the perturbation step. At the end of the step the perturbation load is reset to zero.

If it is specified in a *MODAL DYNAMIC, *STEADY STATE DYNAMICS or *COMPLEX FREQUENCY procedure it means that the data read from the corresponding .eig-file must have been generated taking perturbation into account (and vice versa: for instance, the absence of the perturbation parameter in a *MODAL DYNAMIC procedure requires an .eig-file generated without perturbation parameter in the corresponding *FREQUENCY step).

The loading active in a non-perturbative step is the accumulation of the loading in all previous steps since but not including the last perturbation step (or, if none has occurred, since the start of the calculation), unless OP=NEW has been specified since.

If NLGEOM is specified, the calculation takes geometrically nonlinear effects into account. To this end a nonlinear strain tensor is used (Lagrangian strain for hyperelastic materials, Eulerian strain for deformation plasticity and the deviatoric elastic left Cauchy-Green tensor for incremental plasticity), the step is divided into increments and a Newton iteration is performed within each increment (notice that iterations are also performed for other kinds of nonlinearity, such as material nonlinearity or contact conditions). Although the internally used stresses are the Piola stresses of the second kind, they are transformed into Cauchy (true) stresses before being printed. NLGEOM is only taken into account if the procedure card (such as *STATIC, *DYNAMIC, *COUPLED TEMPERATURE-DISPLACEMENT) allows for it (the *FREQUENCY card, for example, does not directly allow for it). Once the NLGEOM parameter has been selected, it remains active in all subsequent static calculations. With NLGEOM=NO the inclusion of geometrically nonlinear effects can be turned off. It stays active in subsequent steps as well, unless NLGEOM was specified again. To check whether geometric nonlinearity was taken into account in a specific step, look for the message “Nonlinear geometric effects are taken into account” in the output.

The step size and the increment size can be specified underneath the procedure card. The maximum number of increments in the step (for automatic incrementation) can be specified by using the parameter INC (default is 100) for thermomechanical calculations and INCF (default is 10000) for 3D fluid calculations. In coupled fluid-structure calculations INC applies to the thermo-mechanical part of the computations and INCF to the 3D fluid part.

The option THERMAL NETWORK allows the user to perform fast thermal calculations despite the use of specific network elements (e.g. gas pipers, labyrinths etc), which are characterized by a TYPE description on the *FLUID SECTION card. In general, the use of specific network elements triggers the alternating solution of the network and the structure, leading to longer computational times. In thermal calculations with only generic network elements (no TYPE specified on the *FLUID SECTION cards), the temperatures in the network are solved simultaneously with the temperatures on the structural side (which is much faster than the alternating way). Now, sometimes the user would like to use specific elements, despite the fact that only temperatures have to be calculated, e.g. in order to determine the heat transfer coefficients based on flow characteristics such as Prandl and Reynolds number (this requires the use of the user film routine film.f). Specifying THERMAL NETWORK on the FIRST *STEP card in the input deck takes care that in such a case the simultaneous solving procedure is used instead of the alternating one.

the parameter AMPLITUDE can be used to define whether the loading in this step should be ramped (AMPLITUDE=RAMP) or stepped (AMPLITUDE=STEP). With this option the default for the procedure can be overwritten. For example, the default for a *STATIC step is RAMP. By specifying AMPLITUDE=STEP the loading in the static step is applied completely at the beginning of the step. Note, however, that amplitudes on the individual loading cards (such as *CLOAD, *BOUNDARY....) take precedence.

Finally, the parameter SHOCK SMOOTHING is used for compressible flow calculations. It leads to a smoothing of the solution and may be necessary to obtain convergence. This parameter must be in the range from 0. to 2. The default ist zero. If no convergence is obtained, this parameter is automatically augmented to 0.001 if its value was zero and to twice its value else and the calculation is repeated (possibly more than once). Smaller values of SHOCK SMOOTHING lead to sharper and more accurate results. One possible strategy ist to start with zero and let CalculiX find out the minimum value for which convergence occurs.

First and only line:

- *STEP
- Enter any needed parameters and their values

Example:

```
*STEP, INC=1000, INCF=20000
```

starts a step and increases the maximum number of thermomechanical increments to complete the step to 1000. The maximum number of 3D fluid increments is set to 20000.

Example files: beamnlp.

7.125 *SUBMODEL

Keyword type: model definition

This keyword is used to define submodel boundaries. A submodel is a part of a bigger model for which an analysis has already been performed. A submodel is used if the user would like to analyze some part in more detail by using a more dense mesh or a more complicated material model, just to name a few reasons. At those locations where the submodel has been cut from the global model, the boundary conditions are derived from the global model results. These are the boundaries defined by the *SUBMODEL card. In addition, in a purely mechanical calculation it allows to map the temperatures to all nodes in the submodel (not just the boundary nodes).

There are four kinds of boundary conditions one may apply: the user may map the displacements from the global model (or temperatures in a purely thermal or a thermo-mechanical calculation) to the boundaries of the submodel, the stresses to the boundaries of the submodel, the forces to the boundaries of the submodel or the user may select to map the temperatures in a purely mechanical calculation to all nodes belonging to the submodel. Mapping the stresses or forces may require fixing a couple of additional nodes to prevent rigid body modes.

In order to perform the mapping (which is basically an interpolation) the global model is remeshed with tetrahedra. The resulting mesh is stored in file TetMasterSubmodel.frd and can be viewed with CalculiX GraphiX.

There are three parameters of which two are required. The parameters TYPE and INPUT are required. TYPE can take the value SURFACE or NODE, depending on whether the user wants to define stress boundary conditions or displacement/temperature/force boundary conditions, respectively. The parameter INPUT specifies the file, in which the results of the global model are stored. This must be a .frd file.

A submodel of the SURFACE type is defined by element face surfaces. These must be defined using the *SURFACE,TYPE=ELEMENT card. Submodels of the NODE type are defined by sets of nodes. It is not allowed to define a local coordinate system (with a *TRANSFORM card) in these nodes. Several submodel cards may be used in one and the same input deck, and they can be of different types. The global result file, however, must be the same for all *SUBMODEL cards. Furthermore, a node (for the NODE type submodel) or an element face (for the SURFACE type submodel) may only belong to at most one *SUBMODEL.

The optional parameter GLOBAL ELSET defines an elset in the global model which will be used for the interpolation of the displacements or stresses

onto the submodel boundary defined underneath the *SUBMODEL card. For the creation of this element set the parameter GENERATE is not allowed (cf. *ELSET). Although this element set contains element numbers belonging to the global model, it must be defined in the submodel input deck using the *ELSET card. For instance, suppose the global model contains elements from 1 to 1000 and that the submodel contains only 10 elements numbered from 1 to 10. Both models have no elements in common, however, they may have element numbers in common (as is the case in this example). Suppose that the global elements to be used for the interpolation of the boundary conditions onto the submodel have the numbers 600 up to 604. Then the following card defines the global elset

```
*ELSET,ELSET=GLOBALSET1
600,601,602,603,604
```

and has to be included in the submodel input deck, although in this deck only elements 1 to 10 are defined by a *ELEMENT card, i.e. in the submodel input deck element numbers are referenced which are not at all defined within the deck. This is fine for submodel decks only.

If no GLOBAL ELSET parameter is used the default GLOBAL ELSET is the complete global model. Global elsets of different *SUBMODEL cards may have elements in common.

Notice that the *SUBMODEL card only states that the model at stake is a submodel and that it defines part of the boundary to be of the nodal or of the surface type. Whether actually displacements or stresses will be applied by interpolation from the global model depends on whether a *BOUNDARY, *DSLOAD, *CLOAD or *TEMPERATURE, card is used, respectively, each of them accompanied by the parameter SUBMODEL.

Mapping displacements or temperatures to the boundary of a submodel is usually very accurate. For stresses, the results may be unsatisfactory, since the stress values stored in the global model (and which are the basis for the interpolation) are extrapolations of integration point values. This frequently leads to a situation in which equilibrium for the submodel is not satisfied. To circumvent this, the user may perform a submodel analysis with displacement boundary conditions, store the forces at the boundaries in the frd-file and use this file as global model for a subsequent submodel analysis with force boundary conditions. In this way a correct force-driven analysis can be performed, for instance for crack propagation analyses in the submodel (displacement-driven analyses prevent the crack from growing).

First line:

- *SUBMODEL
- Enter the parameters TYPE and INPUT and their value, and, if necessary, the GLOBAL ELSET parameter.

Following line for TYPE=NODE:

- Node or node set to be assigned to this surface (maximum 16 entries per line).

Repeat this line if needed.

Following line for TYPE=SURFACE:

- Element face surface (maximum 1 entry per line).

Repeat this line if needed.

Example:

```
*SUBMODEL,TYPE=NODE,INPUT=global.frd
part,
1,
8
```

states that the present model is a submodel. The nodes with number 1, 8 and the nodes in the node set “part” belong to a Dirichlet part of the boundary, i.e. a part on which the displacements are obtained from the global model. The results of the global model are stored in file global.frd. Whether they are really used, depends on whether a *BOUNDARY,SUBMODEL card is defined for these nodes.

Example files: .

7.126 *SUBSTRUCTURE GENERATE

Keyword type: step

This procedure is used to generate a substructure and store the stiffness matrix using the *SUBSTRUCTURE MATRIX OUTPUT keyword card. No loading should be applied.

There is one optional parameter: SOLVER. It determines the package used to solve the ensuing system of equations. The following solvers can be selected:

- PARDISO
- SPOOLES [3, 4].

Default is the first solver which has been installed of the following list: PARDISO, SPOOLES. If none is installed, a substructure generation is not possible.

First line:

- *SUBSTRUCTURE GENERATE
- Enter SOLVER, if needed, and its value.

Example:

```
*SUBSTRUCTURE GENERATE,SOLVER=PARDISO
```

defines a substructure generation step and selects the PARDISO solver as linear equation solver in the step. For this to work, the PARDISO solver must have been linked with CalculiX.

Example files: substructure.

7.127 *SUBSTRUCTURE MATRIX OUTPUT

Keyword type: step

This option is used to define the name of the file in which the stiffness matrix of the substructure is to be stored which is generated within a *SUBSTRUCTURE GENERATE step. This is the only procedure in which this keyword card makes sense.

There is one optional parameter STIFFNESS, and two required parameters FILE NAME and OUTPUT FILE.

The optional parameter STIFFNESS can only take a fixed value: STIFFNESS=YES. The parameter OUTPUT FILE can take the value USER DEFINED or MATRIX. If the value is USER DEFINED the output format resembles a user element definition. For the value MATRIX the resulting stiffness file can be used in a *MATRIX ASSEMBLE keyword. In this way it is defined as superelement and the output format consists of lines listing the row node number, row degree of freedom, column node number, column degree of freedom and matrix entry value.

The required parameter FILE NAME is used to define the name of the file in which the stiffness is to be stored. The extension .mtx is default and cannot be changed. It is automatically appended to the name given by the user.

First line:

- *SUBSTRUCTURE MATRIX OUTPUT
- Enter the parameter FILE NAME and OUTPUT FILE and their values, and optionally, the parameter STIFFNESS with its fixed value.

Example:

```
*SUBSTRUCTURE MATRIX OUTPUT,FILE NAME=substruc,OUTPUT FILE=MATRIX
```

defines file substruc.mtx for the storage of the substructure stiffness matrix in MATRIX format.

Example files: substructure, substructure2.

7.128 *SURFACE

Keyword type: model definition

This option is used to define surfaces made up of nodes or surfaces made up of element faces. A mixture of nodes and element faces belonging to one and the same surface is not possible. There are two parameters: NAME and TYPE. The parameter NAME containing the name of the surface is required. The TYPE parameter takes the value NODE for nodal surfaces and ELEMENT for element face surfaces. Default is TYPE=ELEMENT.

At present, surfaces are used to establish cyclic symmetry conditions and to define contact (including tied contact). The master and slave surfaces in cyclic symmetry conditions must be nodal surfaces. For contact, the slave surface can be a nodal or element face surface, while the master surface has to be a element face surface.

Element faces are identified by the surface label Sx where x is the number of the face. The numbering depends on the element type.

For hexahedral elements the faces are numbered as follows (numbers are node numbers):

- Face 1: 1-2-3-4
- Face 2: 5-8-7-6
- Face 3: 1-5-6-2
- Face 4: 2-6-7-3
- Face 5: 3-7-8-4
- Face 6: 4-8-5-1

for tetrahedral elements:

- Face 1: 1-2-3
- Face 2: 1-4-2
- Face 3: 2-4-3
- Face 4: 3-4-1

and for wedge elements:

- Face 1: 1-2-3
- Face 2: 4-5-6
- Face 3: 1-2-5-4
- Face 4: 2-3-6-5
- Face 5: 3-1-4-6

for quadrilateral plane stress, plane strain and axisymmetric elements:

- Face 1: 1-2
- Face 2: 2-3
- Face 3: 3-4
- Face 4: 4-1
- Face N: in negative normal direction (only for plane stress)
- Face P: in positive normal direction (only for plane stress)

for triangular plane stress, plane strain and axisymmetric elements:

- Face 1: 1-2
- Face 2: 2-3
- Face 3: 3-1
- Face N: in negative normal direction (only for plane stress)
- Face P: in positive normal direction (only for plane stress)

for quadrilateral shell elements:

- Face NEG or 1: in negative normal direction
- Face POS or 2: in positive normal direction
- Face 3: 1-2
- Face 4: 2-3
- Face 5: 3-4
- Face 6: 4-1

for triangular shell elements:

- Face NEG or 1: in negative normal direction
- Face POS or 2: in positive normal direction
- Face 3: 1-2
- Face 4: 2-3
- Face 5: 3-1

Notice that the labels 1 and 2 correspond to the brick face labels of the 3D expansion of the shell (Figure 69).

for beam elements:

- Face 1: in negative 1-direction
- Face 2: in positive 1-direction
- Face 3: in positive 2-direction
- Face 5: in negative 2-direction

The beam face numbers correspond to the brick face labels of the 3D expansion of the beam (Figure 74).

First line:

- *SURFACE
- Enter the parameter NAME and its value, and, if necessary, the TYPE parameter.

Following line for nodal surfaces:

- Node or node set to be assigned to this surface (maximum 1 entry per line).

Repeat this line if needed.

Following line for element face surfaces:

- Element or element set (maximum 1 entry per line).
- Surface label (maximum 1 entry per line).

Repeat this line if needed.

Example:

```
*SURFACE,NAME=left,TYPE=NODE
part,
1,
8
```

assigns the nodes with number 1, and 8 and the nodes belonging to node set part to a surface with name left.

Example:

```
*SURFACE,NAME=new
38,S6
```

assigns the face 6 of element 38 to a surface with name new.

Example files: segment, fullseg.

7.129 *SURFACE BEHAVIOR

Keyword type: model definition, surface interaction

With this option the surface behavior of a surface interaction can be defined. The surface behavior is required for a contact analysis. There is one required parameter PRESSURE-OVERCLOSURE. It can take the value EXPONENTIAL, LINEAR, TABULAR, TIED or HARD.

The exponential pressure-overclosure behavior takes the form in Figure 129. The parameters c_0 and p_0 define the kind of contact. p_0 is the contact pressure at zero distance, c_0 is the distance from the master surface at which the pressure is decreased to 1 % of p_0 . The behavior in between is exponential. A large value of c_0 leads to soft contact, a small value to hard contact. For mortar face-to-face contact the exponential pressure vs. penetration curve is move parallel to the pressure axis such that zero penetration corresponds to zero pressure. Furthermore, negative pressure values are set to zero.

The linear pressure-overclosure behavior (Figure 130) simulates a linear relationship between the pressure and the overclosure. At zero overclosure the pressure is zero as well. For node-to-face penalty contact the user should specify the slope of the pressure-overclosure curve (usually 5 to 50 times the typical Young's modulus of the adjacent materials; the default is the first elastic constant of the first encountered material in the input deck multiplied by 50) and the tension value for large clearances σ_∞ (should be small, typically 0.25 % of the maximum stress expected; the default is the first elastic constant of the first encountered material in the input deck divided by 70,000). The value of c_0 , from which the maximum clearance is calculated for which a spring contact element is generated (by multiplying with the square root of the spring area, cf. Section 6.7.5) can be specified too (default value 10^{-3}). For face-to-face contact only the slope of the pressure-overclosure relationship is needed.

The tabular pressure-overclosure relationship is a piecewise linear curve. The user enters (pressure,overclosure) pairs. Outside the interval specified by the user the pressure stays constant. The value of c_0 , from which the maximum clearance is calculated for which a spring contact element is generated (by multiplying with the square root of the spring area, cf. Section 6.7.5) takes the value 10^{-3} and cannot be changed by the user. Due to programming restraints the use of a tabular pressure-overclosure relationship in a thermomechanical calculation implies the use of a *GAP CONDUCTANCE card defining the thermal conductance across the contact elements.

The tied pressure-overclosure behavior simulates a truly linear relationship between the pressure and the overclosure for positive and negative pressures. At zero overclosure the pressure is zero. It can only be used for face-to-face penalty contact and simulates tied contact between the slave and master face. Notice that all slave faces will be tied to opposite master faces, if any, irrespective whether there is a gap between them or not. The only parameter is the slope of the pressure-overclosure relationship. However, tied contact requires the specification of the stick slope on a *FRICTION card.

Hard pressure-overclosure behavior is internally reduced to linear pressure-

overclosure behavior with the default constants. In case of mortar contact true hard behavior can be simulated by omitting the *SURFACE BEHAVIOR card within the *SURFACE INTERACTION card.

First line:

- *SURFACE BEHAVIOR
- Enter the parameter PRESSURE-OVERCLOSURE and its value.

Following line if PRESSURE-OVERCLOSURE=EXPONENTIAL:

- c_0 .
- p_0 .

Following line if PRESSURE-OVERCLOSURE=LINEAR:

- slope K of the pressure-overclosure curve (> 0).
- σ_∞ (> 0 , irrelevant vor face-to-face contact).
- c_0 (> 0 , irrelevant for face-to-face contact, optional for node-to-face contact)

Following line if PRESSURE-OVERCLOSURE=TABULAR:

- pressure.
- overclosure.

Repeat this line as often as needed.

Following line if PRESSURE-OVERCLOSURE=TIED:

- slope K of the pressure-overclosure curve (> 0).

Example:

```
*SURFACE BEHAVIOR,PRESSURE-OVERCLOSURE=EXPONENTIAL
1.e-4,.1
```

defines a distance of 10^{-4} length units at which the contact pressure is .001 pressure units, whereas the contact pressure at loose contact is 0.1 pressure units.

Example files: contact1, contact2.

7.130 *SURFACE INTERACTION

Keyword type: model definition

This option is used to start a surface interaction definition. A surface interaction data block is defined by the options between a *SURFACE INTERACTION line and either another *SURFACE INTERACTION line or a keyword line that does not define surface interaction properties. All surface interaction options within a data block will be assumed to define the same surface interaction. If a property is defined more than once for a surface interaction, the last definition is used. There is one required parameter, NAME, defining the name of the surface interaction with which it can be referenced in surface interactions (e.g. *CONTACT PAIR). The name can contain up to 80 characters.

If used for penalty contact the surface interaction definition must contain a *SURFACE BEHAVIOR card.

Surface interaction data requests outside the defined ranges are extrapolated in a constant way. Be aware that this occasionally occurs due to rounding errors.

First line:

- *SURFACE INTERACTION
- Enter the NAME parameter and its value.

Example:

```
*SURFACE INTERACTION,NAME=SI1
```

starts a material block with name SI1.

Example files: contact1, contact2.

7.131 *TEMPERATURE

Keyword type: step

This option is used to define temperatures and, for shell and beam elements, temperature gradients within a purely mechanical *STEP definition. *TEMPERATURE should not be used within a pure thermal or combined thermomechanical analysis. In these types of analysis the *BOUNDARY card for degree of freedom 11 should be used instead.

Optional parameters are OP, AMPLITUDE, TIME DELAY, USER, SUBMODEL, STEP, DATA SET, FILE and BSTEP. OP can take the value NEW or MOD. OP=MOD is default and implies that thermal load in different nodes is accumulated over all steps starting from the last perturbation step. Specifying the temperature for a node for which a temperature was defined in a previous step replaces this last value. OP=NEW implies that the temperatures are reinitialised to the initial values. If multiple *TEMPERATURE cards are present in a step this parameter takes effect for the first *TEMPERATURE card only.

For shell elements a temperature gradient can be defined in addition to a temperature. The temperature applies to nodes in the reference surface, the gradient acts in normal direction. For beam elements two gradients can be defined: one in 1-direction and one in 2-direction. Default for the gradients is zero.

The AMPLITUDE parameter allows for the specification of an amplitude by which the temperature is scaled (mainly used for dynamic calculations). Thus, in that case the values entered on the *TEMPERATURE card are interpreted as reference values to be multiplied with the (time dependent) amplitude value to obtain the actual value. At the end of the step the reference value is replaced by the actual value at that time, for use in subsequent steps.

The TIME DELAY parameter modifies the AMPLITUDE parameter. As such, TIME DELAY must be preceded by an AMPLITUDE name. TIME DELAY is a time shift by which the AMPLITUDE definition it refers to is moved in positive time direction. For instance, a TIME DELAY of 10 means that for time t the amplitude is taken which applies to time $t-10$. The TIME DELAY parameter must only appear once on one and the same keyword card.

If the USER parameter is selected the temperature values are determined by calling the user subroutine utemp.f, which must be provided by the user. This applies to all nodes listed beneath the *TEMPERATURE keyword. Any temperature values specified behind the nodal numbers are not taken into account. If the USER parameter is selected, the AMPLITUDE parameter has no effect and should not be used.

The SUBMODEL parameter is used to specify that the nodes underneath the *TEMPERATURE card should get their temperature values by interpolation from a global model. Each of these nodes must be listed underneath exactly one nodal *SUBMODEL card. The SUBMODEL parameter automatically requires the use of the STEP or DATA SET parameter.

In case the global calculation was a *STATIC calculation the STEP parameter specifies the step in the global model which will be used for the interpolation. If results for more than one increment within the step are stored, the last increment is taken.

In case the global calculation was a *FREQUENCY calculation the DATA SET parameter specifies the mode in the global model which will be used for the interpolation. It is the number preceding the string MODAL in the .frd-file and it corresponds to the dataset number if viewing the .frd-file with CalculiX GraphiX. Notice that the global frequency calculation is not allowed to contain preloading nor cyclic symmetry.

If the SUBMODEL card is used no temperature values need be specified. The SUBMODEL parameter and the AMPLITUDE parameter are mutually exclusive.

Temperature gradients are not influenced by the AMPLITUDE parameter.

If more than one *TEMPERATURE card occurs in an input deck, the following rules apply: if a *TEMPERATURE is applied to the same node as in a previous application then the previous value and previous amplitude are replaced.

Finally, temperatures can also be read from an .frd file. The file name has to be specified with the FILE parameter, the step within this file from which the temperatures are to be read can be specified with the BSTEP parameter, default is 1. All temperatures for that step available in the .frd file will be read and stored. In case part of the temperatures is listed explicitly in the input deck and/or part is defined by a user routine and/or part is read from file (by using several *TEMPERATURE cards within one and the same step) it is important to know that reading from file takes precedence. This means that (no matter the order in which the *TEMPERATURE cards are defined in the input deck):

- temperatures defined explicitly in the input deck will be overwritten by file values for the same node
- nodes for which the temperature is supposed to be defined by a user routine will get the file value for this node, if any.

The format is as following:

First line:

- *TEMPERATURE
- enter any parameters, if needed.

Following line (only in the absence of the FILE parameter):

- Node number or node set label.
- Temperature value at the node.
- Temperature gradient in normal direction (shells) or in 2-direction (beams).
- Temperature gradient in 1-direction (beams).

Repeat this line if needed.

Example:

```
*TEMPERATURE
N1,293.
300,473.
301,473.
302,473.
```

assigns a temperature T=293 to all nodes in (node) set N1, and T=473 to nodes 300, 301 and 302.

```
*TEMPERATURE,FILE=temperatures.frd,BSTEP=4
```

will read the temperatures from step 4 in file "temperatures.frd".

Example files: beam8t, beam20t, beamnlt, beamt4, beamfrdread.

7.132 *TIE

Keyword type: model definition

This option is used to tie two surfaces. It can only be used with 3-dimensional elements (no plane stress, plane strain, axisymmetric, beam or shell elements). There is one required parameter NAME. Optional parameters are POSITION TOLERANCE, ADJUST, CYCLIC SYMMETRY and MULTISTAGE. The last two parameters are mutually exclusive. The dependent surface is called the slave surface, the independent surface is the master surface. The user can freely decide which surface is taken as slave and which as master. The surfaces are defined using *SURFACE. Nodes belonging to the dependent surface cannot be used as dependent nodes in other SPC's or MPC's. Only nodes on an axis of cyclic symmetry can belong to both the slave as well as to the master surface.

Default (i.e. in the absence of the CYCLIC SYMMETRY and the MULTISTAGE parameter) is a tie of two adjacent surfaces in a structural calculation. This is also called tied contact. In that case MPC's are generated connecting the slave nodes with the master faces, provided the orthogonal distance between the nodes and the adjacent face does not exceed the POSITION TOLERANCE. If no tolerance is specified, or the tolerance is smaller than 10^{-10} , a default tolerance applies equal to 2.5% of the typical element size. In addition, the projection of the slave node onto the master face must lie within this face or at any rate not farther away (measured parallel to the face) than the default tolerance just defined. For tied contact the slave surface can be a nodal or element face surface, whereas the master surface has to consist of element faces. Nodes which are not connected are stored in file jobname.WarnNodeMissMasterIntersect.nam and can be read into CalculiX GraphiX by using the command "read jobname.WarnNodeMissMasterIntersect.nam inp". Nodes which are connected are automatically adjusted, i.e. the position of the slave nodes is modified such that they lie exactly on the master surface, unless ADJUST=NO was specified by the user. In order to create the MPC's connecting the slave and master side, the latter is triangulated.

The tie can be assigned a name by using the parameter NAME. This name can be referred to on the *CYCLIC SYMMETRY MODEL card.

The parameter CYCLIC SYMMETRY is used to tie two surfaces bounding one and the same datum sector in circumferential direction. Both the slave and the master surface can be node or face based. For face based surfaces the nodes belonging to the face are identified at the start of the algorithm which generates the cyclic multiple point constraints. For each slave node, a master node is determined which matches the slave node within a tolerance specified by the parameter POSITION TOLERANCE after rotation about the cyclic symmetry axis. The latter rotation is an important aspect: for the purpose of generating cyclic symmetry constraints distances are measured in radial planes through the cyclic symmetry axis. Circumferential deviations do NOT enter the calculation of this distance. A separate check, however, verifying whether the geometry matches the number of sectors defined by the user, is performed. For details the reader is referred to *CYCLIC SYMMETRY MODEL. If no tol-

erance is specified, or the tolerance is smaller than 10^{-30} , a default tolerance is calculated equal to 10^{-10} times the mean of the distance of every master node to its nearest neighboring master node. Subsequently, a cyclic symmetry constraint is generated. If no master node is found within the tolerance, the face on the master surface is identified to which the rotated slave node belongs, and a more elaborate multiple point constraint is generated. If none is found, the closest face is taken. If this face does not lie within 10% of its length from the slave node, no MPC's are generated for this node, an error is issued and the node is stored in file `jobname_WarnNodeMissCyclicSymmetry.nam`. This file can be read into CalculiX GraphiX by using the command “read jobname_WarnNodeMissCyclicSymmetry.nam inp”.

The parameter MULTISTAGE is used to tie two coincident nodal surfaces (no face based surfaces allowed) each of which belongs to a different datum sector. In that way two axially neighboring datum sectors can be tied. In this case, the order in which the user specifies the surfaces is not relevant: the surface belonging to the smallest datum sector is taken as master surface. The larger datum sector should not extend the smaller datum sector by more than once the smaller datum sector, no matter in what circumferential direction (clockwise or counterclockwise). This option should not be used in the presence of network elements.

The parameter NAME is needed if more than one *TIE constraint is defined. It allows the user to distinguish the tie constraints when referring to them in other keyword cards (e.g. *CYCLIC SYMMETRY MODEL).

Notice that *TIE can only be used to tie ONE slave surface with ONE master surface. It is not allowed to enter more than one line underneath the *TIE card. Furthermore, *TIE cards must not use a name which has already been used for another *TIE.

First line:

- *TIE
- enter any parameters, if needed.

Following line:

- Name of the slave surface.
- Name of the master surface.

Example:

```
*TIE,POSITION TOLERANCE=0.01
left,right
```

defines a datum sector with slave surface left and master surface right, and defines a position tolerance of 0.01 length units.

Example files: `segment`, `fullseg`.

7.133 *TIME POINTS

Keyword type: model definition

This option may be used to specify a sequence of time points. If the parameter `TIME=TOTAL TIME` is used the reference time is the total time since the start of the calculation, else it is the local step time. The parameter `NAME`, specifying a name for the time point sequence so that it can be referenced by output definitions (`*NODE FILE`, `*EL FILE`, `*NODE PRINT` or `*EL PRINT`) is required (maximum 80 characters). This option makes sense for nonlinear static, nonlinear dynamic, modal dynamic, heat transfer and coupled temperature-displacement calculations only. In all other procedures, this card is ignored.

In each step, the local step time starts at zero. Its upper limit is given by the time period of the step. This time period is specified on the `*STATIC`, `*DYNAMIC`, `*HEAT TRANSFER` or `*COUPLED TEMPERATURE-DISPLACEMENT` keyword card. The default step time period is 1.

The total time is the time accumulated until the beginning of the actual step augmented by the local step time.

`GENERATE` is the second optional parameter. If specified, the user can define a regular pattern of time points by specifying the starting time, the end time and the time increment.

First line:

- *TIME POINTS
- Enter the required parameter `NAME`, and the optional parameter if needed.

Following line, using as many entries as needed, if `GENERATE` is not specified:

- Time.
- Time.
- Time.
- Time.
- Time.
- Time.
- Time.
- Time.

Repeat this line if more than eight entries are needed.

Following line, using as many entries as needed, if `GENERATE` is specified:

- Starting time

- End time
- Time increment

Repeat this line if more than one regular sequence is needed.

Example:

```
*TIME POINTS,NAME=T1
.2,.3,.8
```

defines a time points sequence with name T1 consisting of times .2, .3 and .8 time units. The time used is the local step time.

Example:

```
*TIME POINTS,NAME=T1,GENERATE
0.,3.,1.
```

defines a time points sequence with name T1 consisting of the time points 0., 1., 2., and 3. The time used is the local step time.

Example files: beamnlptp

7.134 *TRANSFORM

Keyword type: model definition

This option may be used to specify a local axis system X' - Y' - Z' to be used for defining SPC's, MPC's and nodal forces. For now, rectangular and cylindrical systems can be defined, triggered by the parameter `TYPE=R` (default) and `TYPE=C`.

A rectangular system is defined by specifying a point a on the local X' axis and a point b belonging to the X' - Y' plane but not on the X' axis. A right hand system is assumed (Figure 164).

When using a cylindrical system two points a and b on the axis must be given. The X' axis is in radial direction, the Z' axis in axial direction from point a to point b, and Y' is in tangential direction such that X' - Y' - Z' is a right hand system (Figure 165).

The parameter `NSET`, specifying the node set for which the transformation applies, is required.

If several transformations are defined for one and the same node, the last transformation takes effect.

Notice that a non-rectangular local coordinate system is not allowed in nodes which belong to plane stress, plane strain, or axisymmetric elements. If a local rectangular system is defined the local z-axis must coincide with the global z-axis (= axis orthogonal to the plane in which these elements are defined).

First line:

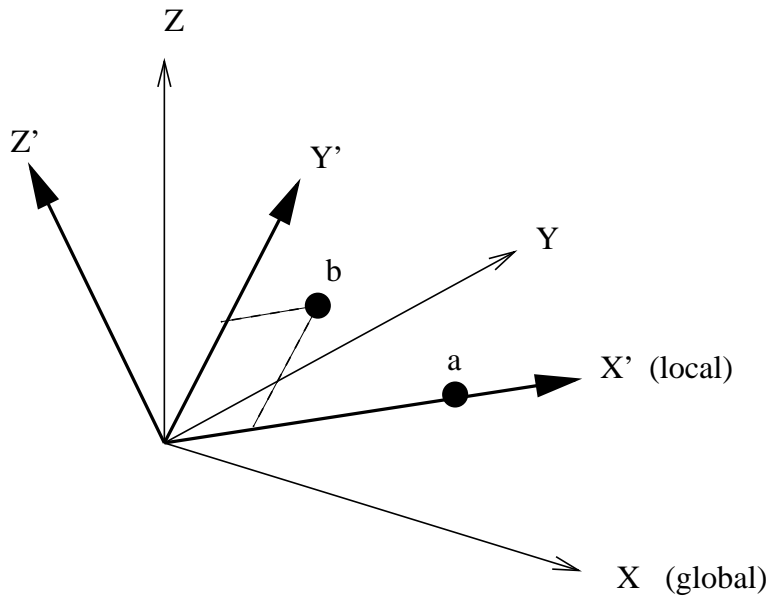

Figure 164: Definition of a rectangular coordinate system

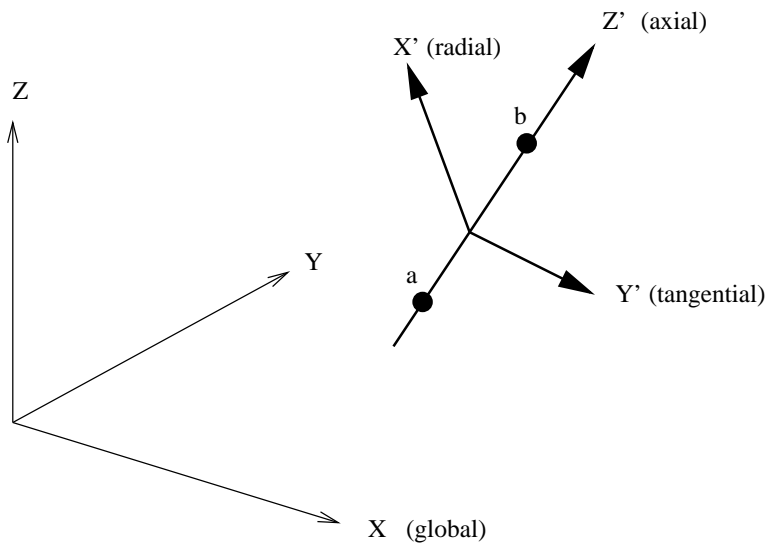

Figure 165: Definition of a cylindrical coordinate system

- *TRANSFORM
- Enter the required parameter NSET, and the optional parameter TYPE if needed.

Second line:

- X-coordinate of point a.
- Y-coordinate of point a.
- Z-coordinate of point a.
- X-coordinate of point b.
- Y-coordinate of point b.
- Z-coordinate of point b.

Example:

```
*TRANSFORM,NSET=No1,TYPE=R
0.,1.,0.,0.,0.,1.
```

assigns a new rectangular coordinate system to the nodes belonging to (node) set No1. The x- and the y-axes in the local system are the y- and z-axes in the global system.

Example files: segment1, segment2, segmentf, segmentm.

7.135 *UNCOUPLED TEMPERATURE-DISPLACEMENT

Keyword type: step

This procedure is used to perform an uncoupled thermomechanical analysis. For each increment a thermal analysis is performed first. Then, the resulting temperature field is used as boundary condition for a subsequent mechanical analysis for the same increment. Consequently, there is no feedback from the mechanical deformation on the temperature field within one and the same increment. Due to the sequential calculations the resulting systems of equations are smaller and faster execution times can be expected. Moreover, the number of iterations within the increment is determined for the thermal and mechanical analysis separately, whereas in a coupled thermomechanical analysis the worst converging type of analysis dictates the number of iterations.

There are eight optional parameters: SOLVER, DIRECT, ALPHA, STEADY STATE, DELTMX, EXPLICIT, TIME RESET and TOTAL TIME AT START.

SOLVER determines the package used to solve the ensuing system of equations. The following solvers can be selected:

- the SGI solver

- PaStiX
- PARDISO
- SPOOLES [3, 4].
- TAUCS
- the iterative solver by Rank and Ruecker [79], which is based on the algorithms by Schwarz [85].

Default is the first solver which has been installed of the following list: SGI, PaStiX, PARDISO, SPOOLES and TAUCS. If none is installed, the default is the iterative solver, which comes with the CalculiX package.

The SGI solver should by now be considered as outdated. SPOOLES is very fast, but has no out-of-core capability: the size of systems you can solve is limited by your RAM memory. With 32GB of RAM you can solve up to 1,000,000 equations. TAUCS is also good, but my experience is limited to the LL^T decomposition, which only applies to positive definite systems. It has an out-of-core capability and also offers a LU decomposition, however, I was not able to run either of them so far. PARDISO is the Intel proprietary solver and is about a factor of two faster than SPOOLES. The most recent solver we tried is the freeware solver PaStiX from INRIA. It is really fast and can use the GPU. For large problems and a high end Nvidia graphical card (32 GB of RAM) we got an acceleration of a factor between 3 and 8 compared to PARDISO. We modified PaStiX for this, therefore you have to download PaStiX from our website and compile it for your system. This can be slightly tricky, however, it is worth it!

What about the iterative solver? If `SOLVER=ITERATIVE SCALING` is selected, the preconditioning is limited to a scaling of the diagonal terms, `SOLVER=ITERATIVE CHOLESKY` triggers Incomplete Cholesky preconditioning. Cholesky preconditioning leads to a better convergence and maybe to shorter execution times, however, it requires additional storage roughly corresponding to the nonzeros in the matrix. If you are short of memory, diagonal scaling might be your last resort. The iterative methods perform well for truly three-dimensional structures. For instance, calculations for a hemisphere were about nine times faster with the `ITERATIVE SCALING` solver, and three times faster with the `ITERATIVE CHOLESKY` solver than with SPOOLES. For two-dimensional structures such as plates or shells, the performance might break down drastically and convergence often requires the use of Cholesky preconditioning. SPOOLES (and any of the other direct solvers) performs well in most situations with emphasis on slender structures but requires much more storage than the iterative solver.

The parameter `DIRECT` indicates that automatic incrementation should be switched off. The increments will have the fixed length specified by the user on the second line.

The parameter `ALPHA` takes an argument between -1/3 and 0. It controls the dissipation of the high frequency response: lower numbers lead to increased numerical damping ([62]). The default value is -0.05.

The parameter STEADY STATE indicates that only the steady state should be calculated. If this parameter is absent, the calculation is assumed to be time dependent and a transient analysis is performed. For a transient analysis the specific heat of the materials involved must be provided.

The parameter DELTMX can be used to limit the temperature change in two subsequent increments. If the temperature change exceeds DELTMX the increment is restarted with a size equal to D_A times DELTMX divided by the temperature change. The default for D_A is 0.85, however, it can be changed by the *CONTROLS keyword. DELTMX is only active in transient calculations. Default value is 10^{30} .

The parameter EXPLICIT is only important for fluid computations. If present, the fluid computation is explicit, else it is semi-implicit. Coupled structural computations are always implicit.

The parameter TIME RESET can be used to force the total time at the end of the present step to coincide with the total time at the end of the previous step. If there is no previous step the targeted total time is zero. If this parameter is absent the total time at the end of the present step is the total time at the end of the previous step plus the time period of the present step (2nd parameter underneath the *UNCOUPLED TEMPERATURE-DISPLACEMENT keyword). Consequently, if the time at the end of the previous step is 10. and the present time period is 1., the total time at the end of the present step is 11. If the TIME RESET parameter is used, the total time at the beginning of the present step is 9. and at the end of the present step it will be 10. This is sometimes useful if transient uncoupled temperature-displacement calculations are preceded by a stationary heat transfer step to reach steady state conditions at the start of the transient uncoupled temperature-displacement calculations. Using the TIME RESET parameter in the stationary step (the first step in the calculation) will lead to a zero total time at the start of the subsequent instationary step.

Finally, the parameter TOTAL TIME AT START can be used to set the total time at the start of the step to a specific value.

First line:

- *UNCOUPLED TEMPERATURE-DISPLACEMENT
- Enter any needed parameters and their values.
- Initial time increment. This value will be modified due to automatic incrementation, unless the parameter DIRECT was specified (default 1.).
- Time period of the step (default 1.).
- Minimum time increment allowed. Only active if DIRECT is not specified. Default is the initial time increment or $1.e-5$ times the time period of the step, whichever is smaller.
- Maximum time increment allowed. Only active if DIRECT is not specified. Default is $1.e+30$.

Example:

```
*UNCOUPLED TEMPERATURE-DISPLACEMENT
.1,1.
```

defines an uncoupled thermomechanical step and selects the SPOOLES solver as linear equation solver in the step (default). The second line indicates that the initial time increment is .1 and the total step time is 1.

Example files: thermomech2.

7.136 *USER ELEMENT

With this option the user can define a user element, i.e. an element created by the user and not available by default in CalculiX. The following parameters are required: TYPE, INTEGRATION POINTS, MAXDOF and NODES.

The TYPE must begin with the letter U and is to be followed by a strictly positive integer not exceeding 9999. It is used in an *ELEMENT card to assign this type to specific elements.

INTEGRATION POINTS defines the number of integration points used in the numerical integration of this element type (maximum 256). It is used for allocation purposes. E.g stresses and strains are usually calculated at the integration points.

The parameter MAXDOF declares the maximum degree of freedom associated with nodes belonging to this element type (maximum 256). Translational degrees of freedom correspond to degrees of freedom 1,2 and 3 rotational degrees of freedom to 4,5 and 6. For instance, shell and beam elements usually contain rotational degrees of freedom, so MAXDOF=6. For volumetric elements MAXDOF is usually 3.

Finally, the parameter NODES specifies the number of nodes associated with this element type (maximum 256).

First line:

- *USER MATERIAL
- Enter the parameters and their value

Example:

```
*USER ELEMENT,TYPE=U1,INTEGRATION POINTS=0,MAXDOF=6,NODES=2
```

defines a user element of type U1 with no integration points (i.e. analytical integration), a maximum degree of freedom of 6 and 2 nodes.

Example files: freq_test, lin_stat_cooks_beam_128, userbeam.

7.137 *USER MATERIAL

Keyword type: model definition, material

This option is used to define the properties of a user-defined material. For a user-defined material a material subroutine has to be provided, see Sections 8.5 and 8.6. There is one required parameter `CONSTANTS` and one optional parameter `TYPE`.

The value of `CONSTANTS` indicates how many material constants are to be defined for this type of material.

The parameter `TYPE` can take the value `MECHANICAL` or `THERMAL`. If `TYPE=MECHANICAL` the user routine characterizes the mechanical behavior of the material, i.e. the stress-strain behavior. This property is only important for mechanical or coupled temperature-displacement calculations. If `TYPE=THERMAL` the user routine defines the thermal behavior of the material, i.e. the heat flux versus temperature gradient behavior. This is only used in thermal or coupled temperature-displacement calculations. Default is `TYPE=MECHANICAL`.

The material is identified by means of the `NAME` parameter on the `*MATERIAL` card.

First line:

- `*USER MATERIAL`
- Enter the `CONSTANTS` parameter and its value

Give on the following $\text{int}(\text{CONSTANTS}/8)+1$ lines the constants followed by the temperature value for which they are valid, 8 values per line. The value of the temperature can be left blank, however, if `CONSTANTS` is a multiple of 8 a value for the temperature is mandatory (if only one set of material constants is given the value of this temperature is irrelevant). Repeat the set of constants if values for more than one temperature are given.

Example:

```
*USER MATERIAL,CONSTANTS=8
500000.,157200.,400000.,157200.,157200.,300000.,126200.,126200.,
294.
300000.,57200.,300000.,57200.,57200.,200000.,26200.,26200.,
394.
```

defines a user-defined material with eight constants for two different temperatures, 294 and 394.

Example files: beamu.

7.138 *USER SECTION

Keyword type: model definition

This option is used to assign material properties to user element sets. The parameters ELSET, MATERIAL and CONSTANTS are required. The parameter ELSET defines the user element set to which the material specified by the parameter MATERIAL applies. Finally, with the parameter CONSTANTS the number of parameters needed to describe the user element (e.g. the thickness for a shell-type user element) is defined.

First line:

- *USER SECTION
- Enter any needed parameters.

Following line:

- First constant
- Second constant
- etc (maximum eight constants on this line)

Repeat this line if more than eight constants are needed to describe the user section.

Example:

```
*USER SECTION, MATERIAL=EL, ELSET=Ea11, CONSTANTS=1
0.01
```

assigns material EL to all elements in (user element) set Ea11. There is one constant with value 0.01.

Example files: .

7.139 *VALUES AT INFINITY

Keyword type: model definition

This keyword is used to define values at infinity for 3D fluid calculations. They are used to calculate the pressure coefficient c_P if requested as output by the user (*NODE FILE) and freestream boundary conditions for the turbulence parameters [57].

First line:

- *VALUES AT INFINITY

Second line:

- Static temperature at infinity
- Norm of the velocity vector at infinity
- Static pressure at infinity
- Density at infinity
- Length of the computational domain

Example:

```
*VALUES AT INFINITY
40.,1.,11.428571,1.,40.
```

specifies a static temperature of 40., a velocity of 1., a static pressure of 11.428571 and a density of 1. at infinity. The size of the computational domain is 40.

Example files: fluid1,fluid2.

7.140 *VIEWFACTOR

Keyword type: step

Sometimes you wish to reuse the viewfactors calculated in a previous run, or store the present viewfactors to file for future use. This can be done using the keyword card *VIEWFACTOR.

There are six optional parameters: READ, WRITE, WRITE ONLY, NO CHANGE, INPUT and OUTPUT. READ/NO CHANGE and WRITE/WRITE ONLY are mutually exclusive, i.e. if you specify READ you cannot specify WRITE or WRITE ONLY and so on. These parameters are used to specify whether you want to read previous viewfactors (READ/NO CHANGE) or store the viewfactors of the present calculation for future runs (WRITE and WRITE ONLY). For reading there is an optional parameter INPUT, for writing there is an optional parameter OUTPUT.

If you specify READ or NO CHANGE, the results will be read from the binary file "jobname.vwf" (which should have been generated in a previous run) unless you use the parameter INPUT. In the latter case you can specify any filename (maximum 126 characters) containing the viewfactors. If the filename contains blanks, it must be delimited by double quotes and the filename should not exceed 124 characters. The geometry of the faces exchanging radiation must be exactly the same as in the actual run. Notice that the parameter INPUT must be preceded by the READ or NO CHANGE parameter. The parameter NO CHANGE has the same effect as the READ parameter except that it additionally specifies that the viewfactors did not change compared with the previous step. If this parameter is selected the LU decomposition of the radiation matrix is not repeated and a lot of computational time can be saved. This parameter can obviously not be used in the first step of the calculation.

In thermal calculations (keyword *HEAT TRANSFER) the viewfactors are calculated at the start of each step since the user can change the radiation boundary conditions in each step. If the viewfactors are not read from file, i.e. if there is no *VIEWFACTOR,READ or *VIEWFACTOR,NO CHANGE card in a step they are calculated from scratch. In thermomechanical calculations (keyword *COUPLED TEMPERATURE-DISPLACEMENT) the viewfactors are calculated at the start of each iteration. Indeed, the deformation of the structure in the previous iteration can lead to a change of the viewfactors. However, if the user reads the viewfactors from file the recalculation of the viewfactors in each iteration anew is turned off. In that case it is assumed that the viewfactors do not change during the entire step.

If you specify WRITE or WRITE ONLY, the viewfactors will be stored in binary format in file "jobname.vwf" unless you use the parameter OUTPUT. In the latter case you can specify any filename (maximum 125 characters) in which the viewfactors are to be written. Any existing file with this name will be deleted prior to the writing operation. If the filename contains blanks, it must be delimited by double quotes and the filename should not exceed 123 characters. Notice that the parameter OUTPUT must be preceded by the WRITE or WRITE ONLY parameter. If you specify WRITE ONLY the program stops after calculating and storing the viewfactors.

A *VIEWFACTOR card is only active in the step in which it occurs.

First and only line:

- *VIEWFACTOR
- specify either READ or WRITE

Example:

```
*VIEWFACTOR,WRITE
```

will store the viewfactors calculated in that step to file.

Example:

```
*VIEWFACTOR,READ,INPUT=viewfactors.dat
```

will read the viewfactors from file viewfactors.dat.

Example files: furnace.

7.141 *VISCO

Keyword type: step

This procedure is used to perform a static analysis for materials with viscus behavior. The syntax is identical to the *STATIC syntax, except for the

extra parameter CETOL. This parameter is required and defines the maximum difference in viscous strain within a time increment based on the viscous strain rate at the start and the end of the increment. To get an idea of its size one can divide the stress increase one would typically allow within a time increment by the E-modulus.

Although the specification of the CETOL parameter is mandatory, it is only used so far for materials for which the elastic behavior is linear and isotropic.

Notice that the default way of applying loads in a *VISCO step is step loading, i.e. the loading is fully applied at the start of the step. This is different from a *STATIC step, in which the loading is ramped. Using a *VISCO step only makes sense if at least one materials exhibits viscous behavior.

8 User subroutines.

Although the present software is protected by the GNU General Public License, and the user should always get the source code, it is sometimes more practical to get a nicely described user interface to plug in your own routines, instead of having to analyze the whole program. Therefore, for specific tasks well-defined interfaces are put at the disposal of the user. These interfaces are basically FORTRAN subroutines containing a subroutine header, a description of the input and output variables and declaration statements for these variables. The body of the routine has to be written by the user.

To use a user subroutine, replace the dummy routine in the CalculiX distribution by yours (e.g. dflux.f from the distribution by the dflux.f you wrote yourself) and recompile.

8.1 Creep (creep.f)

The user subroutine “creep.f” is made available to allow the user to incorporate his own creep law by selecting the keyword sequence *CREEP,LAW=USER in the input deck. The input/output depends on the kind of material: if the elastic properties of the material are isotropic, the Von Mises stress goes in and the equivalent deviatoric creep strain increment and its derivative with respect to the Von Mises stress for a given Von Mises stress come out. If the elastic properties of the material are anisotropic, the equivalent deviatoric creep strain increment goes in and the Von Mises stress and the derivative of the equivalent deviatoric creep strain increment with respect to the Von Mises stress come out. The creep regime is, however, always isotropic. Whether the elastic regime is isotropic or anisotropic is triggered by the value of the variable lend. The header and a description of the input and output variables is as follows:

```

subroutine creep(decra,deswa,statev,serd,ec,esw,p,qtild,
& temp,dtemp,predef,dpred,time,dtime,cmname,leximp,lend,
& coords,nstatv,noel,npt,layer,kspt,kstep,kinc)

```

```

!
!   user creep routine
!
!   INPUT (general):
!
!   statev(1..nstatv)  internal variables
!   serd                not used
!   ec(1)              equivalent creep at the start of the increment
!   ec(2)              not used
!   esw(1..2)          not used
!   p                  not used
!   temp               temperature at the end of the increment
!   dtemp              not used
!   predef             not used
!   dpred              not used
!   time(1)            value of the step time at the end of the increment
!   time(2)            value of the total time at the end of the increment
!   dtime              time increment
!   cmname             material name
!   leximp             not used
!   lend               if = 2: isotropic creep
!                     if = 3: anisotropic creep
!   coords(1..3)      coordinates of the current integration point
!   nstatv             number of internal variables
!   noel               element number
!   npt                integration point number
!   layer              not used
!   kspt               not used
!   kstep              not used
!   kinc               not used
!
!   INPUT only for elastic isotropic materials:
!   qtild              von Mises stress
!
!   INPUT only for elastic anisotropic materials:
!   decra(1)           equivalent deviatoric creep strain increment
!
!
!   OUTPUT (general):
!
!   decra(1)           equivalent deviatoric creep strain increment
!   decra(2..4)        not used
!   decra(5)           derivative of the equivalent deviatoric
!                     creep strain increment w.r.t. the von Mises
!                     stress
!   deswa(1..5)        not used

```

```

!
!   OUTPUT only for elastic isotropic materials:
!   decra(1)           equivalent deviatoric creep strain increment
!
!   OUTPUT only for elastic anisotropic materials:
!   qtild             von Mises stress
!

```

8.2 Hardening (uhardening.f)

In subroutine “uhardening.f”, the user can insert his own isotropic and/or kinematic hardening laws for (visco)plastic behavior governed by the keyword sequence *PLASTIC,HARDENING=USER. The header and variable description is as follows:

```

      subroutine uhardening(amat,iel,iint,t1l,epini,ep,dtime,fiso,dfiso,
&                          fkin,dfkin)
!
!   INPUT:
!
!   amat:   material name (maximum 80 characters)
!   iel:    element number
!   iint:   integration point number
!   t1l:    temperature at the end of the increment
!   epini:  equivalent irreversible strain at the start
!           of the increment
!   ep:     present equivalent irreversible strain
!   dtime:  time increment
!
!   OUTPUT:
!
!   fiso:   present isotropic hardening Von Mises stress
!   dfiso:  present isotropic hardening tangent (derivative
!           of the Von Mises stress with respect to the
!           equivalent irreversible strain)
!   fkin:   present kinematic hardening Von Mises stress
!   dfkin:  present kinematic hardening tangent (derivative
!           of the Von Mises stress with respect to the
!           equivalent irreversible strain)
!

```

8.3 User-defined initial conditions

These routines are an alternative to the explicit inclusion of the initial conditions underneath the *INITIAL CONDITIONS keyword card in the input deck. They allow for a more flexible definition of initial conditions.

8.3.1 Initial internal variables (sdvini.f)

This subroutine is used for user-defined internal variables, characterized by the parameter USER on the *INITIAL CONDITIONS,TYPE=SOLUTION card. The header and variable description is as follows:

```

      subroutine sdvini(statev,coords,nstatv,ncrds,noel,npt,
& layer,kspt)
!
!   user subroutine sdvini
!
!
!   INPUT:
!
!   coords(1..3)      global coordinates of the integration point
!   nstatv            number of internal variables (must be
!                   defined by the user with the *DEPVAR card)
!   ncrds            number of coordinates
!   noel             element number
!   npt              integration point number
!   layer            not used
!   kspt             not used
!
!   OUTPUT:
!
!   statev(1..nstatv) initial value of the internal state
!                   variables

```

8.3.2 Initial stress field (sigini.f)

This subroutine is used for user-defined initial stresses, characterized by the parameter USER on the *INITIAL CONDITIONS,TYPE=STRESS card. The header and variable description is as follows:

```

      subroutine sigini(sigma,coords,ntens,ncrds,noel,npt,layer,
& kspt,lrebar,rebarn)
!
!   user subroutine sigini
!
!   INPUT:
!

```

```

!   coords           coordinates of the integration point
!   ntens            number of stresses to be defined
!   ncrds            number of coordinates
!   noel             element number
!   npt              integration point number
!   layer            currently not used
!   kspt             currently not used
!   lrebar           currently not used (value: 0)
!   rebarn           currently not used
!
!   OUTPUT:
!
!   sigma(1..ntens)  initial stress values in the integration
!                   point. If ntens=6 the order of the
!                   components is 11,22,33,12,13,23
!
!

```

8.4 User-defined loading

These routines are made available to define nonuniform distributed loading. The user can define the loading in each integration point separately as a function of position, time etc.

8.4.1 Concentrated flux (cflux.f)

This subroutine is used for user-defined concentrated heat flux, characterized by the parameter `USER` on the `*CFLUX` card. For the header and variable description the reader is referred to `cflux.f` in the source code.

8.4.2 Concentrated load (cload.f)

This subroutine is used for user-defined concentrated load, characterized by the parameter `USER` on the `*CLOAD` card. The header and variable description is as follows:

```

      subroutine cload(xload,kstep,kinc,time,node,idof,coords,vold,
&  mi,ntrans,trab,inotr,veold)
!
!   user subroutine cload
!
!   INPUT:
!
!   kstep           step number
!   kinc            increment number
!   time(1)         current step time
!   time(2)         current total time

```



```

!      node          node number
!      idof          degree of freedom
!      coords(1..3)  global coordinates of the node
!      vold(0..mi(2)
!                   ,1..nk)  solution field in all nodes (for modal
!                               dynamics: in all nodes for which output
!                               was requested or a force was applied)
!                               0: temperature
!                               1: displacement in global x-direction
!                               2: displacement in global y-direction
!                               3: displacement in global z-direction
!                               4: static pressure
!      mi(1)          max # of integration points per element (max
!                               over all elements)
!      mi(2)          max degree of freedom per node (max over all
!                               nodes) in fields like v(0:mi(2))...
!      veold(0..3,1..nk)  derivative of the solution field w.r.t.
!                               time in all nodes(for modal
!                               dynamics: in all nodes for which output
!                               was requested or a force was applied)
!                               0: temperature rate
!                               1: velocity in global x-direction
!                               2: velocity in global y-direction
!                               3: velocity in global z-direction
!      ntrans         number of transform definitions
!      trab(1..6,i)   coordinates of two points defining transform i
!      trab(7,i)      -1: cylindrical transformation
!                   1: rectangular transformation
!      inotr(1,j)     transformation number applied to node j
!      inotr(2,j)     a SPC in a node j in which a transformation was
!                               applied corresponds to a MPC. inotr(2,j)
!                               contains the number of a new node generated
!                               for the inhomogeneous part of the MPC
!
!      OUTPUT:
!
!      xload          concentrated load in direction idof of node
!                   "node" (global coordinates)
!

```

8.4.3 Distributed flux (dflux.f)

This subroutine is used for nonuniform heat flux, characterized by distributed load labels of the form SxNUy, cf *DFLUX. The load label can be up to 20 characters long. In particular, y can be used to distinguish different nonuniform flux patterns. The header and variable description is as follows:

```

      subroutine dflux(flux,sol,kstep,kinc,time,noel,npt,coords,
&      jltyp,temp,press,loadtype,area,vold,co,lakonl,konl,
&      ipompc,nodempc,coefmpc,nmpc,ikmpc,ilmpc,yscale,mi,
&      sti,xstateini,xstate,nstate_,dtime)
!
!      user subroutine dflux
!
!
!      INPUT:
!
!      sol          current temperature value
!      kstep        step number
!      kinc         increment number
!      time(1)      current step time
!      time(2)      current total time
!      noel        element number
!      npt         integration point number
!      coords(1..3) global coordinates of the integration point
!      jltyp       loading face kode:
!                  1 = body flux
!                  11 = face 1
!                  12 = face 2
!                  13 = face 3
!                  14 = face 4
!                  15 = face 5
!                  16 = face 6
!      temp        currently not used
!      press       currently not used
!      loadtype    load type label
!      area        for surface flux: area covered by the
!                  integration point
!                  for body flux: volume covered by the
!                  integration point
!      vold(0..4,1..nk) solution field in all nodes
!                  0: temperature
!                  1: displacement in global x-direction
!                  2: displacement in global y-direction
!                  3: displacement in global z-direction
!                  4: static pressure
!      co(3,1..nk) coordinates of all nodes
!                  1: coordinate in global x-direction
!                  2: coordinate in global y-direction
!                  3: coordinate in global z-direction
!      lakonl     element label
!      konl(1..20) nodes belonging to the element
!      ipompc(1..nmpc) ipompc(i) points to the first term of

```

```

!
!           MPC i in field nodempc
!   nodempc(1,*)   node number of a MPC term
!   nodempc(2,*)   coordinate direction of a MPC term
!   nodempc(3,*)   if not 0: points towards the next term
!                   of the MPC in field nodempc
!                   if 0: MPC definition is finished
!   coefmpc(*)     coefficient of a MPC term
!   nmpc           number of MPC's
!   ikmpc(1..nmpc) ordered global degrees of freedom of the MPC's
!                   the global degree of freedom is
!                   8*(node-1)+direction of the dependent term of
!                   the MPC (direction = 0: temperature;
!                   1-3: displacements; 4: static pressure;
!                   5-7: rotations)
!   ilmpc(1..nmpc) ilmpc(i) is the MPC number corresponding
!                   to the reference number in ikmpc(i)
!   mi(1)          max # of integration points per element (max
!                   over all elements)
!   mi(2)          max degree of freedom per node (max over all
!                   nodes) in fields like v(0:mi(2))...
!   sti(i,j,k)     actual Cauchy stress component i at integration
!                   point j in element k. The components are
!                   in the order xx,yy,zz,xy,xz,yz
!   xstateini(i,j,k) value of the state variable i at integration
!                   point j in element k at the beginning of the
!                   present increment
!   xstate(i,j,k)  value of the state variable i at integration
!                   point j in element k at the end of the
!                   present increment
!   nstate_        number of state variables
!   dtime          time length of the increment
!
!
!   OUTPUT:
!
!   flux(1)        magnitude of the flux
!   flux(2)        not used; please do NOT assign any value
!   iscale         determines whether the flux has to be
!                   scaled for increments smaller than the
!                   step time in static calculations
!                   0: no scaling
!                   1: scaling (default)

```

8.4.4 Distributed load (dload.f)

This subroutine is used for nonuniform pressure, characterized by distributed load labels of the form PxNUy, cf *DLOAD. The load label can be up to 20 characters long. In particular, y can be used to distinguish different nonuniform loading patterns. The header and variable description is as follows:

```

      subroutine dload(f,kstep,kinc,time,noel,npt,layer,kspt,
&      coords,jltyp,loadtype,vold,co,lakonl,konl,
&      ipompc,nodempc,coefmpc,nmpc,ikmpc,ilmpc,iscalc,veold,
&      rho,amat,mi)
!
!      user subroutine dload
!
!
!      INPUT:
!
!      kstep          step number
!      kinc           increment number
!      time(1)        current step time
!      time(2)        current total time
!      noel           element number
!      npt            integration point number
!      layer          currently not used
!      kspt           currently not used
!      coords(1..3)  global coordinates of the integration point
!      jltyp          loading face kode:
!                   21 = face 1
!                   22 = face 2
!                   23 = face 3
!                   24 = face 4
!                   25 = face 5
!                   26 = face 6
!      loadtype       load type label
!      vold(0..4,1..nk) solution field in all nodes
!                   0: temperature
!                   1: displacement in global x-direction
!                   2: displacement in global y-direction
!                   3: displacement in global z-direction
!                   4: static pressure
!      veold(0..3,1..nk) derivative of the solution field w.r.t.
!                   time in all nodes
!                   0: temperature rate
!                   1: velocity in global x-direction
!                   2: velocity in global y-direction
!                   3: velocity in global z-direction
!      co(3,1..nk)   coordinates of all nodes

```

```

!           1: coordinate in global x-direction
!           2: coordinate in global y-direction
!           3: coordinate in global z-direction
!   lakonl      element label
!   konl(1..20) nodes belonging to the element
!   ipompc(1..nmpc) ipompc(i) points to the first term of
!                   MPC i in field nodempc
!   nodempc(1,*) node number of a MPC term
!   nodempc(2,*) coordinate direction of a MPC term
!   nodempc(3,*) if not 0: points towards the next term
!                   of the MPC in field nodempc
!                   if 0: MPC definition is finished
!   coefmpc(*)  coefficient of a MPC term
!   nmpc        number of MPC's
!   ikmpc(1..nmpc) ordered global degrees of freedom of the MPC's
!                   the global degree of freedom is
!                   8*(node-1)+direction of the dependent term of
!                   the MPC (direction = 0: temperature;
!                   1-3: displacements; 4: static pressure;
!                   5-7: rotations)
!   ilmpc(1..nmpc) ilmpc(i) is the MPC number corresponding
!                   to the reference number in ikmpc(i)
!   rho        local density
!   amat       material name
!   mi(1)     max # of integration points per element (max
!                   over all elements)
!   mi(2)     max degree of freedomm per node (max over all
!                   nodes) in fields like v(0:mi(2))...
!
!   OUTPUT:
!
!   f         magnitude of the distributed load
!   iscale    determines whether the flux has to be
!                   scaled for increments smaller than the
!                   step time in static calculations
!                   0: no scaling
!                   1: scaling (default)
!
!

```

8.4.5 Heat convection (film.f)

This subroutine is used for nonuniform convective heat flux, characterized by distributed load labels of the form FxNUy, cf *FILM. The load label can be up to 20 characters long. In particular, y can be used to distinguish different nonuniform film patterns. The header and variable description is as follows:

```

      subroutine film(h,sink,temp,kstep,kinc,time,noel,npt,
&  coords,jltyp,field,nfield,loadtype,node,area,vold,mi,
&  ipkon,kon,lakon,iponoel,inoel,ielprop,prop,ielmat,
&  shcon,nshcon,rhcon,nrhcon,ntmat_,cocon,ncocon)
!
!  user subroutine film
!
!
!  INPUT:
!
!  sink          most recent sink temperature
!  temp          current temperature value
!  kstep         step number
!  kinc          increment number
!  time(1)       current step time
!  time(2)       current total time
!  noel         element number
!  npt          integration point number
!  coords(1..3) global coordinates of the integration point
!  jltyp        loading face kode:
!               11 = face 1
!               12 = face 2
!               13 = face 3
!               14 = face 4
!               15 = face 5
!               16 = face 6
!  field         currently not used
!  nfield        currently not used (value = 1)
!  loadtype      load type label
!  node         network node (only for forced convection)
!  area         area covered by the integration point
!  vold(0..4,1..nk) solution field in all nodes;
!               for structural nodes:
!               0: temperature
!               1: displacement in global x-direction
!               2: displacement in global y-direction
!               3: displacement in global z-direction
!               4: static pressure
!               for network nodes
!               0: total temperature (at end nodes)
!                  = static temperature for liquids
!               1: mass flow (at middle nodes)
!               2: total pressure (at end nodes)
!                  = static pressure for liquids
!               3: static temperature (at end nodes; only for gas)
!  mi(1)        max # of integration points per element (max

```

```

!           over all elements)
!   mi(2)      max degree of freedom per node (max over all
!              nodes) in fields like v(0:mi(2))...
!   ipkon(i)   points to the location in field kon preceding
!              the topology of element i
!   kon(*)     contains the topology of all elements. The
!              topology of element i starts at kon(ipkon(i)+1)
!              and continues until all nodes are covered. The
!              number of nodes depends on the element label
!   lakon(i)   contains the label of element i
!   iponoel(i) the network elements to which node i belongs
!              are stored in inoel(1,iponoel(i)),
!              inoel(1,inoel(2,iponoel(i)))..... until
!              inoel(2,inoel(2,inoel(2.....))=0
!   inoel(1..2,*) field containing the network elements
!   ielprop(i) points to the location in field prop preceding
!              the properties of element i
!   prop(*)    contains the properties of all network elements. The
!              properties of element i start at prop(ielprop(i)+1)
!              and continues until all properties are covered. The
!              appropriate amount of properties depends on the
!              element label. The kind of properties, their
!              number and their order corresponds
!              to the description in the user's manual,
!              cf. the sections "Fluid Section Types"
!   ielmat(i)  contains the material number for element i
!   shcon(0,j,i) temperature at temperature point j of material i
!   shcon(1,j,i) specific heat at constant pressure at the
!              temperature point j of material i
!   shcon(2,j,i) dynamic viscosity at the temperature point j of
!              material i
!   shcon(3,1,i) specific gas constant of material i
!   nshcon(i)  number of temperature data points for the specific
!              heat of material i
!   rhcon(0,j,i) temperature at density temperature point j of
!              material i
!   rhcon(1,j,i) density at the density temperature point j of
!              material i
!   nrhcon(i)  number of temperature data points for the density
!              of material i
!   ntmat_     maximum number of temperature data points for
!              any material property for any material
!   ncocon(1,i) number of conductivity constants for material i
!   ncocon(2,i) number of temperature data points for the
!              conductivity coefficients of material i
!   cocon(0,j,i) temperature at conductivity temperature point

```

```

!           j of material i
!   cocon(k,j,i)   conductivity coefficient k at conductivity
!                   temperature point j of material i
!
!   OUTPUT:
!
!   h(1)           magnitude of the film coefficient
!   h(2)           not used; please do NOT assign any value
!   sink           (updated) sink temperature (need not be
!                   defined for forced convection)
!   ntmat_         maximum number of temperature data points for
!                   any material property for any material
!   ncocon(1,i)    number of conductivity constants for material i
!   ncocon(2,i)    number of temperature data points for the
!                   conductivity coefficients of material i
!   cocon(0,j,i)   temperature at conductivity temperature point
!                   j of material i
!   cocon(k,j,i)   conductivity coefficient k at conductivity
!                   temperature point j of material i
!
!   OUTPUT:
!
!   h(1)           magnitude of the film coefficient
!   h(2)           not used; please do NOT assign any value
!   sink           (updated) sink temperature (need not be
!                   defined for forced convection)
!   heatnod        extra heat flow going to the network node
!                   (zero if not specified)
!   heatfac        extra heat flow going to the structural face
!                   (zero if not specified)

```

8.4.6 Boundary conditions(uboun.f)

This subroutine is used for user-defined boundary values, characterized by the parameter USER on the *BOUNDARY card. It is called for all degrees of freedom except for degree of freedom 0 or 11 (i.e. temperature). In the latter case the routine utemp.f is called (cf. Section 8.4.8). For the header and variable description the reader is referred to the source code.

8.4.7 Heat radiation (radiate.f)

This subroutine is used for nonuniform radiation heat flux, characterized by distributed load labels of the form RxNUy, cf *RADIATE. The load label can be up to 20 characters long. In particular, y can be used to distinguish different nonuniform radiation patterns. The header and variable description is as follows:

```
!
```



```

subroutine radiate(e,sink,temp,kstep,kinc,time,noel,npt,
& coords,jltyp,field,nfield,loadtype,node,area,vold,mi,
& iemchange)
!
!   user subroutine radiate
!
!
!   INPUT:
!
!   sink           present sink temperature
!   temp           current temperature value
!   kstep          step number
!   kinc           increment number
!   time(1)        current step time
!   time(2)        current total time
!   noel           element number
!   npt            integration point number
!   coords(1..3)   global coordinates of the integration point
!   jltyp          loading face kode:
!                  11 = face 1
!                  12 = face 2
!                  13 = face 3
!                  14 = face 4
!                  15 = face 5
!                  16 = face 6
!   field          currently not used
!   nfield         currently not used (value = 1)
!   loadtype       load type label
!   node           currently not used
!   area           area covered by the integration point
!   vold(0..4,1..nk) solution field in all nodes
!                  0: temperature
!                  1: displacement in global x-direction
!                  2: displacement in global y-direction
!                  3: displacement in global z-direction
!                  4: static pressure
!   mi(1)          max # of integration points per element (max
!                  over all elements)
!   mi(2)          max degree of freedom per node (max over all
!                  nodes) in fields like v(0:mi(2))...
!
!   OUTPUT:
!
!   e(1)           magnitude of the emissivity
!   e(2)           not used; please do NOT assign any value
!   sink           sink temperature (need not be defined

```

```

!           for cavity radiation)
!   iemchange      = 1 if the emissivity is changed during
!                   a step, else zero.
!

```

8.4.8 Temperature (utemp.f)

With this subroutine the user can define a temperature field. It is triggered by the parameter USER on the *TEMPERATURE card or on the *BOUNDARY card for degree of freedom 0 or 11. For the header and variable description the reader is referred to the source code.

8.4.9 Amplitude (uamplitude.f)

With this subroutine the user can define an amplitude. It is triggered by the parameter USER on the *AMPLITUDE card. The header and variable description is as follows:

```

      subroutine uamplitude(time,name,amplitude)
!
!   user subroutine uamplitude: user defined amplitude definition
!
!   INPUT:
!
!   name           amplitude name
!   time           time at which the amplitude is to be
!                   evaluated
!
!   OUTPUT:
!
!   amplitude      value of the amplitude at time
!

```

8.4.10 Face loading (ufaceload.f)

This routine is called at the beginning of each step and can be used to determine the area of faces on which loading is applied. In that way the flux through the face can be calculated and stored in an extra file. This can be beneficial for thermal calculations to check the heat flux due to convection and radiation.

```

      subroutine ufaceload(co,ipkon,kon,lakon,
&   nelemload,sideload,nload)
!
!
!   INPUT:
!
!   co(0..3,1..nk)  coordinates of the nodes

```

```

!   ipkon(*)           element topology pointer into field kon
!   kon(*)            topology vector of all elements
!   lakon(*)          vector with elements labels
!   nelemload(1..2,*) 1: elements faces of which are loaded
!                   2: nodes for environmental temperatures
!   sload(*)          load label
!   nload             number of facial distributed loads
!
!   user routine called at the start of each step; possible use:
!   calculation of the area of sets of elements for
!   further use to calculate film or radiation coefficients.
!   The areas can be shared using common blocks.
!

```

8.4.11 Gap conductance (gapcon.f)

This subroutine is used to define the gap conductance across a contact pair (penalty contact only). cf *GAP CONDUCTANCE. The header and variable description is as follows:

```

      subroutine gapcon(ak,d,flowm,temp,predef,time,ciname,slname,
&   msname,coords,noel,node,npred,kstep,kinc,area)
!
!   user subroutine gapcon
!
!   INPUT:
!
!   d(1)           separation between the surfaces
!   d(2)           pressure transmitted across the surfaces
!   flowm          not used
!   temp(1)        temperature at the slave node
!   temp(2)        temperature at the corresponding master
!                   position
!   predef         not used
!   time(1)        step time at the end of the increment
!   time(2)        total time at the end of the increment
!   ciname         surface interaction name
!   slname         not used
!   msname         not used
!   coords(1..3)  coordinates of the slave node
!   noel           element number of the contact spring element
!   node           slave node number
!   npred          not used
!   kstep          step number
!   kinc           increment number

```

```

!      area              slave area
!
!      OUTPUT:
!
!      ak(1)             gap conductance
!      ak(2..5)         not used
!

```

8.4.12 Gap heat generation (`fricheat.f`)

This subroutine is used to define the gap heat generation across a contact pair (face-to-face penalty contact only), cf `*GAP HEAT GENERATION`. For the header and variable description the user is referred to the source code.

8.5 User-defined mechanical material laws.

User-defined mechanical behavior can be implemented using three different interfaces:

- The native CalculiX interface.
- The ABAQUS umat routines for linear materials (small strain analyses).
- The ABAQUSNL umat routines for nonlinear materials (finite strain analyses).

There are two ways of introducing user-defined mechanical behavior:

- Modify the CalculiX sources. This option is supported for the three interfaces.
- Call a behavior defined in shared libraries.

Each of these approaches has its own advantages and its own pitfalls.

The first one is intrusive and requires a partial recompilation of CalculiX, which means having access to the sources and the rights to install the executable if it is meant to be deployed on a system-wide location.

The second one does not require any modification to CalculiX, is generally easier to set up and is very flexible. There is no intrinsic limitation on the number of shared libraries and functions that can be dynamically loaded. It is thus quite feasible to create mechanical behaviour databases by creating a shared library for each specific material. Such libraries will only be loaded if needed. In such an approach, the mechanical behaviour is dedicated to a specific material and is self-contained: it has no external parameter. Shared libraries can be shared between co-workers by putting them on a shared folder. However, experience shows that using shared libraries can be confusing for some users as they have to update their environment variables (`PATH` on Windows or `LD_LIBRARY_PATH` on Unix) for the libraries to be usable. Shared libraries can also be more sensitive to system updates. A further drawback of using

shared libraries is that the behavior must be written in C or C++ and the name of the functions implementing the behavior must be upper-case due to CalculiX internal conventions¹. The reason of such a restriction is detailed below. One way of generating such library with the appropriate naming convention is to use the MFront code generator:

<http://tfel.sourceforge.net>

8.5.1 The CalculiX interface.

Introduction of a new mechanical behaviour by modifying the sources.

This is an extremely important and powerful interface, allowing the user to define his/her own mechanical material behavior. The subroutine “umat_main.f” is a driver subroutine, calling user-defined routines similar to “umat_user.f”, depending on the kind of material present in the model. To create a new material law, a “umat_user.f” routine must be written and an appropriate call must be inserted in routine “umat_main.f”.

For instance, assume you want to write a material user routine for a Drucker-Prager material model. Let us call this routine umat.drucker_prager.f. To write the routine, you can use the umat_user.f routine as a template. The header of this routine shows you the fields which you have at your disposal.

When you finished writing the routine you have to make it available for selection in routine umat_main.f. The selection is done based on the material name. Let us take DRUCKER-PRAGER for the material name, i.e. if the user wants to select this model with a *USER MATERIAL card, he has to use a name for his material starting with DRUCKER-PRAGER. Material names in CalculiX can be 80 characters long, so the remaining 66 characters after DRUCKER-PRAGER can be used to distinguish between several Drucker-Prager materials used within one and the same input deck, e.g. the user could use DRUCKER-PRAGER1 and DRUCKER-PRAGER2 if he has two different Drucker-Prager materials in his model. Using the block

```

elseif(amat(1:4).eq.'USER') then
!
    amatloc(1:76)=amat(5:80)
    amatloc(77:80)='      '
    call umat_user(amatloc,iel,iint,kode,elconloc,emec,emec0,
&      beta,xikl,vij,xkl,vj,ithermal,t1l,dtime,time,ttime,
&      icmd,ielas,mi(1),nstate_,xstateini,xstate,stre,stiff,
&      iorien,pgauss,orab,pnewdt,ipkon)

```

as template we arrive at:

¹Recent versions of the FORTRAN standard allow a more precise control of the name mangling of FORTRAN functions which could be used to circumvent this issue. Another solution is that FORTRAN implementations can be used using a C wrapper, which is quite feasible but this requires some advanced knowledge of C and FORTRAN interfacing.

```

elseif(amat(1:14).eq.'DRUCKER-PRAGER') then
!
    amatloc(1:66)=amat(15:80)
    amatloc(67:80)='      '
    call umat_drucker-prager(amatloc,iel,iint,kode,elconloc,emec,
&      emec0,beta,xikl,vij,xkl,vj,ithermal,t1l,dtime,time,ttime,
&      icmd,ielas,mi(1),nstate_,xstateini,xstate,stre,stiff,
&      iorien,pgauss,orab,pnewdt,ipkon)

```

which has to be inserted in routine `umat_main.f`. Notice that the DRUCKER-PRAGER part is removed from the material name before entering the subroutine, i.e. if the user has named his material DRUCKER-PRAGER1 only 1 will be transferred to the user subroutine.

After storing `umat_main.f` and `umat_drucker_prager.f`, `umat_drucker_prager.f` has to be added to the FORTRAN routines in `Makefile.inc` and CalculiX has to be recompiled, i.e. a new executable has to be generated.

After this, the Drucker-Prager material routine is at the disposal of the user. To select it, he has to use the *USER MATERIAL card and start the name of this material with DRUCKER-PRAGER. Furthermore, he has to know how many constants he has to define for this material (should be in the documentation of the material model) and how many internal variables there are (to be inserted underneath the *DEPVAR card; should also be in the documentation of the material model). If our Drucker-Prager material is characterized by 4 constants and 2 internal variables (this is out-of-the-blue) the input should look like:

```

*MATERIAL,NAME=DRUCKER-PRAGEREXAMPLE
*USER MATERIAL,CONSTANTS=4
constant1,constant2,constant3,constant4
*DEPVAR
2

```

The header and input/output variables of the `umat_user` routine are as follows:

```

subroutine umat_user(amat,iel,iint,kode,elconloc,emec,emec0,
&      beta,xokl,voj,xkl,vj,ithermal,t1l,dtime,time,ttime,
&      icmd,ielas,mi,nstate_,xstateini,xstate,stre,stiff,
&      iorien,pgauss,orab,pnewdt,ipkon)
!
!      calculates stiffness and stresses for a user defined material
!      law
!
!      icmd=3: calculatates stress at mechanical strain
!      else: calculates stress at mechanical strain and the stiffness
!      matrix
!
!

```

```

! INPUT:
!
! amat          material name
! iel          element number
! iint         integration point number
!
! kode         material type (-100-#of constants entered
!             under *USER MATERIAL): can be used for materials
!             with varying number of constants
!
! elconloc(*)  user defined constants defined by the keyword
!             card *USER MATERIAL (actual # =
!             -kode-100), interpolated for the
!             actual temperature t11
!
! emec(6)     Lagrange mechanical strain tensor (component order:
!             11,22,33,12,13,23) at the end of the increment
!             (thermal strains are subtracted)
! emec0(6)    Lagrange mechanical strain tensor at the start of the
!             increment (thermal strains are subtracted)
! beta(6)     residual stress tensor (the stress entered under
!             the keyword *INITIAL CONDITIONS,TYPE=STRESS)
!
! xokl(3,3)   deformation gradient at the start of the increment
! voj         Jacobian at the start of the increment
! xkl(3,3)    deformation gradient at the end of the increment
! vj         Jacobian at the end of the increment
!
! ithermal    0: no thermal effects are taken into account
!             >0: thermal effects are taken into account (triggered
!             by the keyword *INITIAL CONDITIONS,TYPE=TEMPERATURE)
! t11         temperature at the end of the increment
! dtime       time length of the increment
! time        step time at the end of the current increment
! ttime       total time at the start of the current step
!
! icmd        not equal to 3: calculate stress and stiffness
!             3: calculate only stress
! ielas      0: no elastic iteration: irreversible effects
!             are allowed
!             1: elastic iteration, i.e. no irreversible
!             deformation allowed
!
! mi(1)       max. # of integration points per element in the
!             model
! nstate_     max. # of state variables in the model

```

```

!
! xstateini(nstate_,mi(1),# of elements)
!           state variables at the start of the increment
! xstate(nstate_,mi(1),# of elements)
!           state variables at the end of the increment
!
! stre(6)           Piola-Kirchhoff stress of the second kind
!                   at the start of the increment
!
! iorien           number of the local coordinate axis system
!                   in the integration point at stake (takes the value
!                   0 if no local system applies)
! pgauss(3)        global coordinates of the integration point
! orab(7,*)        description of all local coordinate systems.
!                   If a local coordinate system applies the global
!                   tensors can be obtained by premultiplying the local
!                   tensors with skl(3,3). skl is determined by calling
!                   the subroutine transformatrix:
!                   call transformatrix(orab(1,iorien),pgauss,skl)
! eth(6)           thermal strain at the end of the increment
!
!
! OUTPUT:
!
! xstate(nstate_,mi(1),# of elements)
!           updated state variables at the end of the increment
! stre(6)           Piola-Kirchhoff stress of the second kind at the
!                   end of the increment
! stiff(21):        consistent tangent stiffness matrix in the material
!                   frame of reference at the end of the increment. In
!                   other words: the derivative of the PK2 stress with
!                   respect to the Lagrangian strain tensor. The matrix
!                   is supposed to be symmetric, only the upper half is
!                   to be given in the same order as for a fully
!                   anisotropic elastic material (*ELASTIC,TYPE=ANISO).
!                   Notice that the matrix is an integral part of the
!                   fourth order material tensor, i.e. the Voigt notation
!                   is not used.
! pnewdt           to be specified by the user if the material
!                   routine is unable to return the stiffness matrix
!                   and/or the stress due to divergence within the
!                   routine. pnewdt is the factor by which the time
!                   increment is to be multiplied in the next
!                   trial and should exceed zero but be less than 1.
!                   Default is -1 indicating that the user routine
!                   has converged.

```



```

!      ipkon(*)           ipkon(iel) points towards the position in field
!                        kon prior to the first node of the element's
!                        topology. If ipkon(iel) is smaller than 0, the
!                        element is not used.

```

The parameter *ielas* indicates whether irreversible effects should be taken into account. Forced displacements can lead to huge strains in the first iteration. Therefore, convergence in quasistatic calculations is often enhanced if the first iteration is completely linear, i.e. material and geometric nonlinearities are turned off. The parameter *ielas* is the appropriate flag for this.

Two extra routines are at the user's disposal for conversion purposes. "str2mat.f" can be used to convert Lagrangian strain into Eulerian strain, Cauchy stress into PK2 stress, or Kirchhoff stress into PK2 stress. The header and a short description are as follows:

```

      subroutine str2mat(str,ckl,vj,cauchy)
!
!      converts the stress in spatial coordinates into material coordinates
!      or the strain in material coordinates into spatial coordinates.
!
!      INPUT:
!
!      str(6):      Cauchy stress, Kirchhoff stress or Lagrange strain
!                  component order: 11,22,33,12,13,23
!      ckl(3,3):   the inverse deformation gradient
!      vj:         Jakobian determinant
!      cauchy:     logical variable
!                  if true: str contains the Cauchy stress
!                  if false: str contains the Kirchhoff stress or
!                           Lagrange strain
!
!      OUTPUT:
!
!      str(6):     Piola-Kirchhoff stress of the second kind (PK2) or
!                  Euler strain
!

```

The second routine, "stiff2mat.f" converts the tangent stiffness matrix from spatial coordinates into material coordinates.

```

      subroutine stiff2mat(elas,ckl,vj,cauchy)
!
!      converts an element stiffness matrix in spatial coordinates into

```

```

!      an element stiffness matrix in material coordinates.
!
!      INPUT:
!
!      elas(21):  stiffness constants in the spatial description, i.e.
!                 the derivative of the Cauchy stress or the Kirchhoff
!                 stress with respect to the Eulerian strain
!      ckl(3,3):  inverse deformation gradient
!      vj:        Jacobian determinant
!      cauchy:    logical variable
!                 if true: elas is written in terms of Cauchy stress
!                 if false: elas is written in terms of Kirchhoff stress
!
!      OUTPUT:
!
!      elas(21):  stiffness constants in the material description, i.e.
!                 the derivative of the second Piola-Kirchhoff stress (PK2)
!                 with respect to the Lagrangian strain
!

```

Calling mechanical behaviour defining shared libraries. Calling shared libraries is triggered by putting the @ character in front of the material name. The material name is then decomposed into two parts, separated by the _ character:

- The base name of the library (see below).
- The name of the function implementing the behavior. If the function's name is omitted, the "umat_" function name is used.

For instance, if we want to call a small strain behavior in a linear analysis, implemented by the "CHABOCHE" function in the "libCALCULIXBEHAVIOURS.so" shared library², one would declare the following material name:

@CALCULIXBEHAVIOURS.CHABOCHE

Here, the library name has been stripped from system-specific conventions (the leading lib and the .so extension). *The base name of the library and the name of the function must be upper-case.* This is due to the way CalculiX interprets the input file.

To distinguish two materials using the same external behaviour, one may add a unique identifier at the end of the material name. This identifier starts with the @ character. For example, one may use the material names @CALCULIXBEHAVIOURS.CHABOCHE@1 and @CALCULIXBEHAVIOURS.CHABOCHE@2 to create two distinct materials (with distinct material properties) which will call the same external behaviour.

²Under windows, the library name has the dll extension.

8.5.2 ABAQUS umat routines

There are two interfaces to include ABAQUS umat routines: `umat.abaqus` is meant to include linear materials, `umat.abaqusnl` for nonlinear materials. For nonlinear materials the logarithmic strain and infinitesimal rotation are calculated, which slows down the calculation. Consequently, the nonlinear routine should only be used if necessary.

The linear routine is triggered by putting ABAQUS in front of the material name. The total length of the material name should not exceed 80 characters, consequently, 74 characters are left for the proper material name. For instance, if the material name in the ABAQUS routine is supposed to be “WOOD”, you must specify “ABAQUSWOOD” in the CalculiX input file. The part “ABAQUS” is removed from the name before entering the umat routine.

The nonlinear routine is triggered by putting ABAQUSNL in front of the material name.

Limitations. Notice that the following fields are not supported so far:

`sse`, `spd`, `scd`, `rpl`, `ddsddt`, `drplde`, `drpldt`, `predef`, `dpred`, `drot`, `pnewdt`, `celent`, `layer`, `kspt`. If you need these fields, contact “`dhondt@t-online.de`”. Furthermore, the following fields have a different meaning:

- in the linear version:
 - `stran`:
 - * in CalculiX: Lagrangian strain tensor
 - * in ABAQUS: logarithmic strain tensor
 - `dstran`:
 - * in CalculiX: Lagrangian strain increment tensor
 - * in ABAQUS: logarithmic strain increment tensor
 - `temp`:
 - * in CalculiX: temperature at the end of the increment
 - * in ABAQUS: temperature at the start of the increment
 - `dtemp`:
 - * in CalculiX: zero
 - * in ABAQUS: temperature increment
- in the nonlinear version:
 - `temp`:
 - * in CalculiX: temperature at the end of the increment
 - * in ABAQUS: temperature at the start of the increment
 - `dtemp`:
 - * in CalculiX: zero

* in ABAQUS: temperature increment

Notice that CalculiX uses double precision. Furthermore, it is good practice to use “implicit none” instead of “implicit real*8(a-h,o-z)”. Therefore it is advised to use “implicit none” in your ABAQUS routine and to declare all reals with “real*8”.

Calling shared libraries. Calling shared libraries is triggered by putting the @ character in front material name. The material name is then decomposed into three parts, separated by the _ character:

- The name of the interface (ABAQUS or ABAQUSNL).
- The base name of the library (see below).
- The name of the function implementing the behavior. If the function’s name is omitted, the “umat_” function name is used.

For instance, if we want to call a small strain behavior in a linear analysis, implemented by the “CHABOCHE” function in the “libABAQUSBEHAVIOURS.so” shared library³, one would declare the following material name:

@ABAQUS_ABAQUSBEHAVIOURS_CHABOCHE

Here, the library name has been stripped from system-specific convention (the leading lib and the .so extension). *The base name of the library and the name of the function must be upper-cased.* This is due to the way CalculiX interprets the input file.

To distinguish two materials using the same external behaviour, one may add a unique identifier at the end of the material name. This identifier starts with the @ character. For example, one may use the material names @ABAQUS_ABAQUSBEHAVIOURS_CHABOCHE@1 and @ABAQUS_ABAQUSBEHAVIOURS_CHABOCHE@2 to create two distinct materials (with distinct material properties) which will call the same external behaviour.

8.6 User-defined thermal material laws.

Thermal behavior not available in CalculiX can be coded by the user in subroutine “umatht.f”. This also applies to any behavior of the thermally equivalent models such as shallow water theory etc. For instance, the thickness of the oil film in lubrication is part of the equivalent conductivity coefficients. A mechanical part can be coupled with the oil region by incorporating the effect of the motion of the mechanical part on the oil film thickness in a thermal material user-subroutine. The header and input/output variables of the umatht routine are as follows:

³Under windows, the library name has the dll extension.

```

!           3: coordinate in global z-direction
!   lakonl           element label
!   konl(1..20)     nodes belonging to the element
!   ipompc(1..nmpc) ipompc(i) points to the first term of
!                   MPC i in field nodempc
!   nodempc(1,*)    node number of a MPC term
!   nodempc(2,*)    coordinate direction of a MPC term
!   nodempc(3,*)    if not 0: points towards the next term
!                   of the MPC in field nodempc
!                   if 0: MPC definition is finished
!   coefmpc(*)      coefficient of a MPC term
!   nmpc            number of MPC's
!   ikmpc(1..nmpc) ordered global degrees of freedom of the MPC's
!                   the global degree of freedom is
!                   8*(node-1)+direction of the dependent term of
!                   the MPC (direction = 0: temperature;
!                   1-3: displacements; 4: static pressure;
!                   5-7: rotations)
!   ilmpc(1..nmpc) ilmpc(i) is the MPC number corresponding
!                   to the reference number in ikmpc(i)
!   mi(1)           max # of integration points per element (max
!                   over all elements)
!   mi(2)           max degree of freedom per node (max over all
!                   nodes) in fields like v(0:mi(2))...
!
!   OUTPUT:
!
!   u               not used
!   dudt            not used
!   dudg(ntgrd)     not used
!   flux(ntgrd)     heat flux at the end of the increment
!   dfdt(ntgrd)     not used
!   dfdg(ntgrd,ntgrd) variation of the heat flux with respect to the
!                   spatial temperature gradient
!   statev(nstatv) internal state variables at the end of the
!                   increment
!
!

```

8.7 User-defined nonlinear equations

This user subroutine allows the user to insert his/her own nonlinear equations (also called Multiple Point Constraints or MPC's). The driver routine is "nonlinmpc.f". For each new type of equation the user can define a name, e.g. FUN (maximum length 80 characters). To be consistent, the user subroutine should be called `umpc_fun` and stored in "umpc_fun.f". In file "nonlinmpc.f" the lines

```

elseif(labmpc(ii)(1:4).eq.'USER') then
    call umpc_user(aux,aux(3*maxlenmpc+1),const,
&          aux(6*maxlenmpc+1),iaux,n,fmpc(ii),iit,idiscon)

```

should be duplicated and user (USER) replaced by fun (FUN).

It is assumed that the nonlinear equation is a function of the displacements only. Then it can generally be written as

$$f(u_1, u_2, u_3, \dots, u_n) = 0 \quad (884)$$

where u_i represents the displacement in node n_i in direction l_i . Nonlinear equations are solved by approximating them linearly and using an iterative procedure. It is the linearization which must be provided by the user in the subroutine. Assume we arrived at an intermediate solution $u_1^0, u_2^0, \dots, u_n^0$. Then the above equation can be linearly approximated by:

$$f(u_1^0, u_2^0, \dots, u_n^0) + \sum_{i=1}^{i=n} \left. \frac{\partial f}{\partial u_i} \right|_0 (u_i - u_i^0) = 0 \quad (885)$$

For more details the user is referred to [23]. To use a user-defined equation its name must be specified on the line beneath the keyword *MPC, followed by a list of all the nodes involved in the MPC. This list of nodes is transferred to the user routine, as specified by the following header and input/output variables of the umpc_user routine:

```

subroutine umpc_user(x,u,f,a,jdof,n,force,iit,idiscon)
!
! updates the coefficients in a user mpc
!
! INPUT:
!
! x(3,n)          Cartesian coordinates of the nodes in the
!                  user mpc.
! u(3,n)          Actual displacements of the nodes in the
!                  user mpc.
! jdof           Actual degrees of freedom of the mpc terms
! n              number of terms in the user mpc
! force          Actual value of the mpc force
! iit            iteration number
!
! OUTPUT:
!
! f              Actual value of the mpc. If the mpc is
!                  exactly satisfied, this value is zero

```

```

!      a(n)           coefficients of the linearized mpc
!      jdof          Corrected degrees of freedom of the mpc terms
!      idiscon       0: no discontinuity
!                   1: discontinuity
!                   If a discontinuity arises the previous
!                   results are not extrapolated at the start of
!                   a new increment
!

```

The subroutine returns the value of $f(f(u_1^0, u_2^0, \dots, u_n^0))$, the coefficients of the linearization $(\frac{df}{du_i} \Big|_0)$ and the degrees of freedom involved.

The parameter `idiscon` can be used to specify whether a discontinuity took place. This usually means that the degrees of freedom in the MPC changed from the previous call. An example of this is a gap MPC. If a discontinuity occurred in an increment, the results (displacements..) in this increment are NOT extrapolated to serve as an initial guess in the next increment.

An example is given next.

8.7.1 Mean rotation MPC.

This MPC is used to apply a rotation to a set of nodes. An important application constitutes rotations on shell and beam elements, see Sections 6.2.14 and 6.2.33. The rotation is characterized by its size (angle in radians) and its axis (normal vector). All nodes participating in the rotation should be listed three times (once for each DOF). The user must define an extra node at the end in order to define the size and axis of rotation: the coordinates of the extra node are the components of a vector on the rotation axis, the first DOF of the node is interpreted as the size of the rotation. This size can be defined using a `*BOUNDARY` card. Applying a mean rotation implies that the mean of the rotation of all participating nodes amounts to a given value, but not the individual rotations per se. The complement of the mean rotation is the torque needed for the rotation. By selecting `RF` on a `*NODE PRINT` or `*NODE FILE` card this torque can be saved in the `.dat` or `.frd` file. Conversely, instead of specifying the mean rotation one can also specify the torque (specify a force with `*CLOAD` on the first DOF of the extra node) and calculate the resulting mean rotation.

The more nodes are contained in a mean rotation MPC the longer the non-linear equation. This leads to a large, fully populated submatrix in the system of equations leading to long solution times. Therefore, it is recommended not to include more than maybe 50 nodes in a mean rotation MPC.

Example:

```

*NODE
162,0.,1.,0.
*MPC

```



```

MEANROT,3,3,3,2,2,2,14,14,14,39,39,39,42,42,42,
50,50,50,48,48,48,162
..
*STEP
*STATIC
*BOUNDARY
162,1,1,.9
..
*END STEP

```

specifies a mean rotation MPC. Its size is 0.9 radians = 51.56° and the global y-axis is the rotation axis. The participating nodes are 3,2,14,39,42,50 and 48.

Example files: beammr, beammrco.

The theory behind the mean rotation MPC is explained in [23], Section 3.6, in case that all nodes are lying in a plane orthogonal to the rotation axis. If this is not the case, the derivation in [23] is not correct and has to be extended. Indeed, for the general case \mathbf{p}'_i and \mathbf{u}'_i in Equation (3.98) of that reference have to be replaced by their projection on a plane orthogonal to the rotation vector \mathbf{a} . The projection $\mathbf{P}\mathbf{y}$ of a vector \mathbf{y} is given by:

$$\mathbf{P}\mathbf{y} = \mathbf{y} - (\mathbf{y} \cdot \mathbf{a})\mathbf{a}. \quad (886)$$

Defining $\mathbf{b}_i \equiv \mathbf{P}\mathbf{p}'_i$ Equation (3.101) of the reference has to be replaced by (no implicit summation in this section)

$$\lambda_i = \frac{(\mathbf{b}_i \times \mathbf{P}\mathbf{u}'_i) \cdot \mathbf{a}}{\|\mathbf{b}_i\| \cdot \|\mathbf{b}_i + \mathbf{P}\mathbf{u}'_i\|} \quad (887)$$

(recall that the vector product of a vector with itself vanishes). λ_i is the sinus of the angle between $\mathbf{P}\mathbf{p}'_i$, which is the projected vector from the center of gravity of the nodal set for which the mean rotation MPC applies to one of its nodes i , and $\mathbf{P}\mathbf{p}'_i + \mathbf{P}\mathbf{u}'_i$, which is the projection of the vector connecting the deformed position of the center of gravity with the deformed position of node i . The mean rotation in the mean rotation MPC is supposed to be equal to a given angle γ , i.e. the equation to be satisfied is:

$$\sum_{i=1}^N \sin^{-1} \lambda_i \equiv \sum_{i=1}^N \gamma_i = N\gamma. \quad (888)$$

In order to find the coefficients of the linearization we concentrate here on the derivation of $\frac{\partial \lambda_i}{\partial \mathbf{u}_p}$. One readily finds the following relationships:

$$\frac{\partial \|\mathbf{y}\|}{\partial \mathbf{u}} = \frac{\mathbf{y}}{\|\mathbf{y}\|} \cdot \frac{\partial \mathbf{y}}{\partial \mathbf{u}}, \quad (889)$$

$$\frac{\partial \mathbf{P}\mathbf{y}}{\partial \mathbf{u}} = [\mathbf{I} - \mathbf{a} \otimes \mathbf{a}] \cdot \frac{\partial \mathbf{y}}{\partial \mathbf{u}} \equiv \mathbb{P} \cdot \frac{\partial \mathbf{y}}{\partial \mathbf{u}}, \quad (890)$$

$$\mathbf{a} \cdot (\mathbf{y} \times \mathbb{P}) = \mathbf{a} \times \mathbf{y}. \quad (891)$$

Furthermore, since $\mathbf{b}_i + \mathbf{P}\mathbf{u}'_i \perp \mathbf{a}$ one obtains

$$(\mathbf{b}_i + \mathbf{P}\mathbf{u}'_i) \cdot \mathbb{P} = \mathbf{b}_i + \mathbf{P}\mathbf{u}'_i. \quad (892)$$

Finally, since (Equation (3.96) of the reference)

$$\mathbf{u}'_i = \bar{\mathbf{u}}_i - \frac{1}{N} \sum_j \mathbf{u}_j, \quad (893)$$

one further finds

$$\frac{\partial \mathbf{u}'_i}{\partial \mathbf{u}_p} = \mathbf{I} \cdot (\delta_{ip} - \frac{1}{N}), \quad (894)$$

where \mathbf{I} is the unit second order tensor. Using the above formulas one arrives at

$$\frac{\partial \lambda_i}{\partial \mathbf{u}_p} = \frac{(\delta_{ip} - \frac{1}{N})}{\|\mathbf{b}_i + \mathbf{P}\mathbf{u}'_i\|} \left[\mathbf{a} \times \frac{\mathbf{b}_i}{\|\mathbf{b}_i\|} - \lambda_i \frac{\mathbf{b}_i + \mathbf{P}\mathbf{u}'_i}{\|\mathbf{b}_i + \mathbf{P}\mathbf{u}'_i\|} \right], \quad (895)$$

and

$$\frac{\partial \gamma_i}{\partial \mathbf{u}_p} = \frac{1}{\sqrt{1 - \lambda_i^2}} \frac{(\delta_{ip} - \frac{1}{N})}{\|\mathbf{b}_i + \mathbf{P}\mathbf{u}'_i\|} \left[\mathbf{a} \times \frac{\mathbf{b}_i}{\|\mathbf{b}_i\|} - \lambda_i \frac{\mathbf{b}_i + \mathbf{P}\mathbf{u}'_i}{\|\mathbf{b}_i + \mathbf{P}\mathbf{u}'_i\|} \right], \quad (896)$$

which replaces Equation (3.109) of the reference.

8.7.2 Maximum distance MPC.

This MPC is used to specify that the (Euclidean) distance between two nodes a and b must not exceed a given distance d. A fictitious node c must be defined using the *NODE card. The distance d should be assigned to the first coordinate of c, the other coordinates are arbitrary. The first DOF of c should be assigned a value of zero by means of a *BOUNDARY card. Since all DOFs of nodes a and b are used in the MPC, these nodes must be listed three times. Notice that due to this MPC discontinuities can arise.

Example:

```
*NODE
262,7.200000,0.,0.
*MPC
DIST,129,129,129,10,10,10,262
..
*STEP
*STATIC
```

```
*BOUNDARY
262,1,1,0.
..
*END STEP
```

specifies a maximum distance MPC. The distance between nodes 129 and 10 is not allowed to exceed 7.2 units.

Example file: dist.

8.7.3 Network MPC.

By using the subroutines `networkmpc.lhs.f` and `networkmpc.rhs.f` in combination with the keyword `*NETWORK MPC` the user can define an arbitrary linear or nonlinear equation between the degrees of freedom in a network, i.e. the total temperature, total pressure and mass flow. For details the user is referred to the source code and the `*NETWORK MPC` keyword.

Example file: `networkmpc`.

8.8 User-defined elements

8.8.1 Network element

Details on how a user network element can be defined are described in Section 6.4.25. Here, the structure of the network element subroutine is described in detail. The routine is called for each element of the appropriate user type. For the list of variables transferred into the routine the user is referred to the skeleton file `user_network_element_p0.f` and example file `user_network_element_p1.f`.

A user network element is described by an equation expressing the relationship between the total pressure at the end nodes, the total temperature at the end nodes and the mass flow through the element:

$$f(p_{t_1}, p_{t_2}, T_{t_1}, T_{t_2}, \dot{m}) = 0 \quad (897)$$

Not all these variables have to be present. In order to specify the relevant variables the fields `nodef` and `idirf` and the scalar `numf` are used. In `nodef` the relevant nodes numbers are stored, in `idirf` the direction: total temperature=0, mass flow=1 and total pressure=2. If the element was defined by the nodes 50, 108 and 3338 (`node1`, `node2` and `node3`) and only the total pressures and mass flow occur in the equation `nodef` and `idirf` could look like:

- `nodef(1)=50, idirf(1)=2`
- `nodef(2)=108, idirf(2)=1`
- `nodef(3)=3338, idirf(3)=2`

numf is the number of variables, here numf=3.

The structure of the user subroutine is governed by the variable iflag. If iflag=0 the variable identity should be returned expressing whether the element routine is needed at all (identity=.false. if the routine is needed). For instance, if all variables have been defined using boundary conditions the routine is not relevant.

If iflag=1 the user should return the mass flow based on the knowledge of all other variables.

If iflag=2 the actual value of f and the derivative of f w.r.t. all active degrees of freedom (expressed by fields nodef and idirf) should be calculated and returned.

Finally, if iflag=3 fields are calculated for output in the jobname.net file.

At the end of the file an adjustment is made for axisymmetric structures. Axisymmetric elements in CalculiX are expanded into a 3-dimensional sector of $360^\circ/\text{iaxial}$. Therefore, the mass flow, which is usually provided in the network element routine for 360° , has to be adjusted appropriately. The same applies to the derivative of the governing element equation w.r.t. the mass flow.

For a user-defined network element two additional routines have to be completed:

- calcgeomelemnet.f. In this routine the cross section of the element is defined. This is only needed for pipe-like elements (label starting with UP), for which the total and static temperatures differ.
- calcheatnet.f. In this routine the heat generated within the element can be defined, if any. If nonzero, this heat is inserted into the downstream node of the element.

For details on these subroutines, the user is referred to the comments at the start of these routines.

9 Programming rules.

CalculiX CrunchiX is a mixture of FORTRAN77 (with elements from FORTRAN90) and C. C is primarily used for automatic allocation and reallocation purposes. FORTRAN is the first language I learned and I must admit that I'm still a FORTRAN addict. I use C where necessary, I avoid it where possible. Roughly speaking, the main routine and some of the routines called by main are in C, the others are in FORTRAN. This means that no C routine is called by a FORTRAN routine, a FORTRAN routine may be called by a C routine or a FORTRAN routine. There are NO commons in the code. All data transfer is through arguments of subroutine calls. All arguments are transferred by address, not value (there may be one or two exceptions on this rule in the code).

In summary, the following programming rules apply:

- C calls C or FORTRAN, FORTRAN only calls FORTRAN

- Data transfer to subroutines is ALWAYS by address (not value). This applies to the C-to-C data transfer and the C-to-FORTRAN transfer. The reason for this rule is that FORTRAN always transfers by address.
- Subroutines should be written in lower case. Upper case variables or mixed variables should not be used
- All FORTRAN routines are started with “implicit none”. For choosing names of variables, however, you should stick to the “implicit real(a-h,o-z)” rule, i.e. integers start by the letters i up to n, reals by the letters a up to h and o up to z. Characters and logicals can start by any character. This applies to C and FORTRAN.
- In C-routines only one-dimensional arrays or scalar should be defined and used. More-dimensional arrays should not be used in C. This is because C and FORTRAN store more-dimensional arrays in different ways. Therefore, I prefer to limit the use of more-dimensional arrays to the FORTRAN routines.
- In FORTRAN, common statements should not be used.
- In FORTRAN, *INFO, *WARNING and *ERROR messages should print a blank line (write(*,*)) at the end, unless the routines inputinfo.f, input-warning.f or inputerror.f are called (which contain the blank line printing on their own).
- Avoid the transfer of logical variables from C to FORTRAN.
- For sections of the code which are parallellized (multithreading):
 - avoid logical variables
 - avoid internal read and write statements (use the ichar function instead)
 - avoid external read and write statements

This set of rules grew out of my long-year experience with C and FORTRAN. These are personal preferences, and some of them are really useful in order to avoid different-to-trace programming errors. If you want to contribute to CalculiX, I expect you to adhere to these rules.

Starting with version 2.8 the environment variable `CCX_LOG_ALLOC` has been introduced. If set to 1 (default is zero) one gets detailed information on all allocated, reallocated and deallocated fields during the execution of CalculiX. This may be particularly important during debugging of segmentation faults.

10 Program structure.

The main subroutine of CalculiX is `ccx.2.21.c`. It consists roughly of the following parts:

- Allocation of the fields

For each step:

1. Reading the step input data (including the prestep data for the first step)
2. Determining the matrix structure
3. Filling and solving the set of equations, storing the results.

10.1 Allocation of the fields

This section consists of three subroutine calls:

- `openfile`
- `readinput`
- `allocation`

10.1.1 `openfile`

In this subroutine the input (`.inp`) and output files (`.dat`, `.frd`, `.sta`, `.cvg`) are opened. The `.dat` file contains data stored with `*NODE PRINT` and `*EL PRINT`, the `.frd` file contains data stored with `*NODE FILE` and `*EL FILE`, the `.sta` and `.cvg` file contain information on the convergence of the calculation.

10.1.2 `readinput`

This subroutine reads the input and stores it in field `inpc`. Before storing, the following actions are performed:

- the blanks are deleted
- all characters are changed to uppercase except file names
- the comment lines are not stored
- the include statements are expanded

Furthermore, the number of sets are counted and stored in `nset_`, the number of lines in `inpc` are stored in `nline`. The variable `nset_` is used for subsequent allocation purposes. Finally, the order in which `inpc` is to be read is stored in the fields `ipoinp` and `inp`. Indeed, some keyword cards cannot be interpreted before others were read, e.g. a material reference in a `*SOLID SECTION` card cannot be interpreted before the material definition in the `*MATERIAL` card was read. The order in which keyword cards must be read is defined in field `nameref` in subroutine `keystart.f`. Right now, it reads:

1. `*RESTART,READ`

2. *NODE
3. *USER ELEMENT
4. *ELEMENT
5. *MATRIX ASSEMBLE
6. *NSET
7. *ELSET
8. *TRANSFORM
9. *MATERIAL
10. *DISTRIBUTION
11. *ORIENTATION
12. *SURFACE
13. *TIE
14. *SURFACE INTERACTION
15. *INITIAL CONDITIONS
16. *AMPLITUDE
17. *CONTACTPAIR
18. *COUPLING
19. everything else

This means that *RESTART,READ has to be read before all other cards, then comes *NODE etc. The way inpc is to be read is stored in the fields ipoinp, inp and ipoinpc. The two-dimensional field ipoinp consists of 2 columns and nentries rows, where nentries is the number of keyword cards listed in the list above, i.e. right now nentries=19. The first column of row i in field ipoinp contains a row number of field inp, for instance j1. Then, the first column of row j1 in field inp contains the line number where reading for keyword i should start, the second column contains the line number where reading should end and the third column contains the line number in field inp where the reading information for keyword i continues, else it is zero. If it is zero the corresponding row number in inp is stored in the second column of row i in field ipoinp. Lines are stored consecutively in field inpc (without blanks and without comment lines). Line l1 starts at ipoinpc(l1-1)+1 (first character) and ends at ipoinpc(l1) (last character). Notice that ipoinpc(0)=0. This structure uniquely specifies in what order field inpc must be read. This is also illustrated in Figure 166

If you want to add keywords in the above list you have to

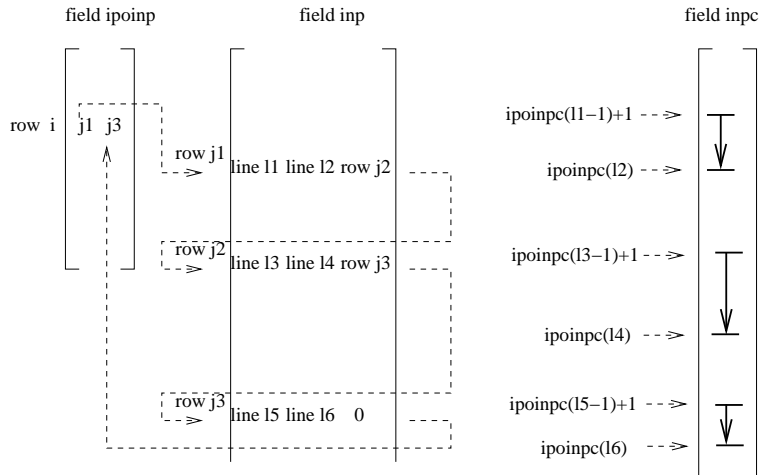
Figure 166: Reading the lines for keyword entry i

- update nentries in the parameter statement in the FORTRAN subroutines allocation.f, calinput.f, keystart.f, getnewline.f and writeinput.f
- update the initialization of nentries in the C-routines ccx_2.21.c, readinput.c and readnewmesh.c.
- update the data statement for the field nameref in the FORTRAN subroutines keystart.f and writeinput.f
- update the data statement for the field namelen in the FORTRAN subroutine keystart.f. It contains the number of characters in each keyword.
- look for the block running

```

else if(strcmp1(&buff[0], "*ORIENTATION")==0){
    FORTRAN(keystart, (&ifreeinp, ipoinp, inp, "ORIENTATION",
                    nline, &ikey));
}

```

in file readinput.c, copy the block and replace ORIENTATION by the new keyword.

- insert the new keyword in the comment list at the beginning of subroutine keystart.f
- update this section of the documentation, i.e. insert the new keyword in the list above and change the value for nentries;

10.1.3 allocate

In the subroutine `allocation.f` the input is read to determine upper bounds for the fields in the program. These upper bounds are printed so that the user can verify them. These upper bounds are used in the subsequent allocation statements in `ccx_2.21.c`. This procedure might seem slightly awkward, however, since the subroutines reading the input later on are in FORTRAN77, a reallocation is not possible at that stage. Therefore, upper bounds must have been defined.

It is important to know where fields are allocated, reallocated and deallocated. Most (re-, de-) allocation is done in `ccx_2.21.c`. Table (19) gives an overview where the allocation (A), reallocation (R) and deallocation (D) is done in file `ccx_2.21.c`. A fundamental mark in this file is the call of subroutine `calinput`, where the input data is interpreted. A couple of examples: field `kon` contains the topology of the elements and is allocated with size `nkon`, which is an upper bound estimate, before all steps. After reading the input up to and including the first step in subroutine `calinput` the field is reallocated with the correct size, since at that point all elements are read and the exact size is known. This size cannot change in subsequent steps since it is not allowed to define new elements within steps. The field `xforc` is allocated with the upper bound estimate `nforc_` before entering subroutine `calinput`. After reading the input up to and including the first step its size is reallocated with the true size `nforc`. Before entering `calinput` to read the second step (or any subsequent step) `xforc` is reallocated with size `nforc_`, since new forces can be defined in step two (and in any subsequent step). After reading step two, the field is reallocated with the momentary value of `nforc`, and so on. All field which can change due to step information must be reallocated in each step.

Table 19: Allocation table for file ccx.2.21.c.

	before calinput		after calinput			size
	< step 1 or irstrt(1)<0	> step 1	= step 1	> step 1	≥ step 1	
co	A	R			R	3*nk
kon	A		R		network _l 0:R	nkon
ipkon	A		R		network _l 0:R	ne
lakon	A		R		network _l 0:R	8*ne
iuel	A		D			nuel_
ielprop	A		nprop>0: R else D		nprop > 0 and network> 0: R	ne
prop	A		nprop>0: R else D			nprop
nodeboun	A	R			R	nboun
ndirboun	A	R			R	nboun
typeboun	A	R			R	nboun+1
xboun	A	R			R	nboun
ikboun	A	R			R	nboun
ilboun	A	R			R	nboun
iamboun	A	nam > 0: R	nam ≤ 0: D		nam > 0: R	nboun
nodebounold		irstrt(1) < 0: A	A	R/R		nboun
ndirbounold		irstrt(1) < 0: A	A	R/R		nboun
xbounold		irstrt(1) < 0: A	A	R/R		nboun
ipompc	A	R			R	nmpc
labmpc	A	R			R	20*nmpc+1
ikmpc	A	R			R	nmpc
ilmpc	A	R			R	nmpc
fmpc	A	R			R	nmpc
nodempc	A					3*memmpc_
coefmpc	A					memmpc_

Table 19: (continued)

	before calinput		after calinput			size
	< step 1	> step 1	= step 1	> step 1	≥ step 1	
coeff ikdc edc	A A A		ncf>0: R else: D ncf>0: R else: D ncf>0: R else: D			7*nfc ndc 12*ndc
nodeforc ndirforc xforc ikforc ilforc iamforc xforcold idefforc	A A A A A A A A	R R R R R nam > 0: R irst(1) < 0: A A	nam ≤ 0: D A	R	R R R R R nam > 0: R D	2*nforc nforc nforc nforc nforc nforc nforc
nelemload sideload xload iamload xloadold ideffload	A A A A A	R R R nam > 0: R irst(1) < 0: A A	nam ≤ 0: D A	R	R R R nam > 0 R network > 0: R D	2*nload 20*nload 2*nload 2*nload 2*nload
cbody ibody xbody xbodyold idefbody	A A A A A	R R R R A			R R R R D	81*nbody 3*nbody 7*nbody 7*nbody
filab prlab prset	A A A					87*nlabel 6*nprint_ 81*nprint_

10.1 Allocation of the fields

Table 19: (continued)

	before calinput		after calinput			size
	< step 1	> step 1	= step 1	> step 1	≥ step 1	
set	A		R			81*nset
istartset	A		R			nset
iendset	A		R			nset
ialset	A		R			nalset
elcon	A		R			(ncmat_+1)* *ntmat_*nmat
nelcon	A		R			2*nmat
rhcon	A		R			2*ntmat_*nmat
nrhcon	A		R			nmat
shcon	A		R			4*ntmat_*nmat
nshcon	A		R			nmat
cocon	A		R			7*ntmat_*nmat
ncocon	A		R			2*nmat
alcon	A		R			7*ntmat_*nmat
nalcon	A		R			2*nmat
alzero	A		R			nmat
dacon	ndamp>0: A		ndamp>0: R			nmat
xmodal	A					11+nevdamp_
plicon	npmat_>0: A		npmat_ > 0: R			(2*npmat_+1)* *ntmat_*nmat
nplicon	npmat_>0: A		npmat_ > 0: R			(ntmat_+1)*nmat
plkcon	npmat_>0: A		npmat_ > 0: R			(2*npmat_+1)* *ntmat_*nmat
nplkcon	npmat_>0: A		npmat_ > 0: R			(ntmat_+1)*nmat

Table 19: (continued)

	before calinput		after calinput			size
	< step 1	> step 1	= step 1	> step 1	≥ step 1	
orname	A		norien > 0: R else:D			80*norien
orab	A		norien > 0: R else:D			7*norien
ielorien	A		norien > 0: R else:D		norien > 0 and network >0: R	mi[2]*ne
trab	A		ntrans > 0: R else:D			7*ntrans
inotr	A	ntrans > 0: R	ntrans ≤ 0: D		ntrans > 0: R	2*nk
amname	A	nam > 0: R	nam > 0: R else:D	nam > 0: R		80*nam
amta	A	nam > 0: R	nam > 0: R else:D	nam > 0: R		2*namta[3*nam-2]
namta	A	nam > 0: R	nam > 0: R else:D	nam > 0: R		3*nam
t0	A	ithermal ≠ 0 R	ithermal = 0: D		ithermal ≠ 0 R	nk
t1	A	ithermal ≠ 0 R	ithermal = 0: D		ithermal ≠ 0 R	nk
iamt1	A	ithermal ≠ 0: R	nam ≤ 0 or ithermal = 0: D ithermal ≠ 0: A		ithermal ≠ 0 and nam > 0: R	nk
t1old		irstrt(1) < 0, ithermal ≠ 0: A	ithermal ≠ 0: A	ithermal ≠ 0: R		nk
t0g	if 1D/2D/U: A	if 1D/2D/U and ithermal ≠ 0: R	if 1D/2D/U and ithermal = 0: D		if 1D/2D/U ithermal ≠ 0: R	2*nk
t1g	if 1D/2D/U: A	if 1D/2D/U and ithermal ≠ 0: R	if 1D/2D/U and ithermal = 0: D		if 1D/2D/U ithermal ≠ 0: R	2*nk

10.1 Allocation of the fields

Table 19: (continued)

	before calinput		after calinput			size
	< step 1	> step 1	= step 1	> step 1	≥ step 1	
ielmat	A		R		network>0: R	mi[2]*ne
matname	A		R			80*nmat
vold	A	R	R	R	nmethod = 4/5/8/9 or (nmethod = 1 and iperturb ≥ 2): R else: D nmethod = 4 and iperturb > 1: A	mt*nk
veold	A	nmethod ≠ 4/5/8/9 and (nmethod ≠ 1 or iperturb < 2): A else: R				mt*nk
accold						mt*nk
vel	A					8*nef
velo	A					8*nef
veloo	A					8*nef
only if ne1d ≠ 0 or ne2d ≠ 0						
iponor	A		R		network>0: R	2*nkon
xnor	A		R			infree[0]
knor	A		R			infree[1]
thickn	A		D			-
thicke	A		R			mi[2]*nkon
offset	A		R			2*ne
iponoel	A		R			infree[3]
inoel	A		R			3*(infree[2]-1)
rig	A		R			infree[3]
ne2boun	A		R			2*infree[3]
ics	ncs_ > 0 or npt_ > 0: A		ncs_>0: R else npt_>0: D			ncs_
dcs	ncs_ > 0 or npt_ > 0: A		ncs_>0 or npt_>0: D			-
cs	ntie_ > 0: A	irstrt(1)<0 and mcs>ntie_: R	mcs > 0: R else: D			17*mcs

Table 19: (continued)

	before calinput		after calinput			size
	< step 1	> step 1	= step 1	> step 1	≥ step 1	
sti eme ener		irstrt(1) < 0: A irstrt(1) < 0: A irstrt(1) < 0 and nener=1: A	A A		network >0: R network >0: R nener=1 and nenerold=0: A nener=1 and network>0: R	6*mi[0]*ne 6*mi[0]*ne mi[0]*ne*2
xstate	A		R			nstate_*mi[0] * (ne+nslavs) (!F2F) * (ne+nintpoint) (F2F)
tieset tietol	ntie ≥ 0: A ntie ≥ 0: A					
prestr	A		iprestr = 1/2: R else:D		iprestr > 0 and	6*mi[0]*ne
islavsurf pslavsurf clearini	A	irstrt(1)<0 and mortar=1: A irstrt(1)<0 and mortar=1: A				2*ifacecount+2 3*nintpoint 27*ifacecount
nodedesi dgdglob g0 xdesi objectset	nobject_>0: A nobject_>0: A nobject_>0: A nobject_>0: A nobject_>0: A					nk_ nobject_*2*nk_ nobject_ 3*nk_ 405*nobject_
irandomtype randomval	irobustdesign >0: A irobustdesign >0: A					nk_ 2*nk_

10.1 Allocation of the fields

Note: ithermal(1) and ithermal are in this manual synonymous.

10.1.4 restart

If a *RESTART,WRITE card is present in the input deck a restart file is written (extension .rout) in subroutine restartwrite.f (called from ccx_2.21.c).

If a *RESTART,READ card is detected a restart file (extension .rin) is read in the following subroutines, all of them called by ccx_2.21.c:

- readinput.c → restartshort.f → skip.f: used to determine the number of sets in the input deck
- allocation.f → restartshort.f → skip.f: used to read the number of nodes, elements, boundary conditions ..
- calinput.f → restarts.f → restartread.f: detailed reading of all information in the input deck, i.e. not only the number of nodes but also the coordinates of all nodes etc.

If the restart information is changed, i.e. if restartwrite.f is changed in any way also files restartshort.f, skip.f and restartread.f have to be modified appropriately.

10.2 Reading the step input data

For each step the input data are read in subroutine calinput.f. For the first step this also includes the prestep data. The order in which the data is read was explained in the previous section (fields ipoinp and inp).

For each keyword card there is a subroutine, most of them are just the keyword with the letter 's' appended. For instance, *STEP is read in subroutine steps.f, *MATERIAL in materials.f. Some obey the plural building in English: *FREQUENCY is read in frequencies.f. Some are abbreviated: *CYCLIC SYMMETRY MODEL is read in cysymmods.f. Treating more than 60 keyword cards accounts in this way for roughly one fourth of all subroutines.

At this point it may be useful to talk about a couple of important structures in the code.

10.2.1 SPC's

The first one is the cataloguing algorithm for SPC's (single point constraints, *BOUNDARY). Let's say a boundary condition m is defined for node i in direction j^* . According to the input deck rules j^* can take the following values:

- For structures:
 - 0 or 11: temperature
 - 1..3: translational dofs
 - 4..6: rotational dofs
- For networks:

- 0 or 11: total temperature
- 1: mass flow
- 2: total pressure
- For 3-dimensional CFD-calculations:
 - 0 or 11: static temperature
 - 1..3: velocity
 - 8: static pressure
- For electromagnetic calculations:
 - 8: electric potential

The value j^* is first mapped onto j using $j = j^*$ except for:

- $j^* = 8$ is mapped onto $j = 4$
- $j^* = 11$ is mapped onto $j = 0$ (11 was kept out of compatibility with Abaqus).

Since static pressure is only used for fluids, rotations only for structures, and the electric potential only for electromagnetic calculations the triple use of dof 4 is no problem: it is not possible that a pressure and a rotation is applied in the same node. The same applies to the other degrees of freedom. For instance, $j=2$ can be a displacement (in global y-direction) in a structural node, a total pressure in a network node or a velocity (in global y-direction) in a CFD-calculation.

Then, a degree of freedom $idof = 8 * (i - 1) + j$ is assigned to this boundary condition. Subsequently, it is stored at location k in the one-dimensional field $ikboun$, where all previous boundary degrees of freedom are stored in numerical order such that $ikboun(k - 1) < idof < ikboun(k + 1)$. Furthermore the number of the boundary condition (m) is stored in $ilboun$: $ilboun(k)=m$, and the node of the boundary condition, its direction and value are stored in the one-dimensional fields $nodeboun$, $ndirboun$ and $xboun$: $nodeboun(m) = i$, $ndirboun(m) = j$ and $xboun(m) = value$. If an amplitude definition applies to the boundary condition, its number n is stored in the one-dimensional field $iamboun$: $iamboun(m) = n$.

The SPC type is stored in the one-dimensional field $typeboun$. SPC's can be of different types, depending on whether they were defined by a genuine *BOUNDARY CARD, or introduced for other reasons. The field $typeboun$ is a one-dimensional character*1 field. Other reasons to introduce SPC's are:

- fixing of the midplane in expanded plane stress/plane strain/axisymmetric elements
- taking care of the inhomogeneous term in nonlinear MPC's such as the PLANE *MPC, the STRAIGHT *MPC, a *RIGID BODY definition or USER *MPC.

The corresponding type code is:

- B = prescribed boundary condition
- M = midplane constraint (plane stress/plane strain/axisymmetric elements)
- P = PLANE MPC
- R = RIGID BODY definition
- S = STRAIGHT MPC
- U = USER MPC

The total number of boundary conditions is stored in variable nboun.

Consequently, ikboun contains all degrees of freedom of the boundary conditions in numerical order, and ilboun contains the corresponding boundary condition numbers. This assures that one can quickly check whether a given degree of freedom was used in a SPC. For example, if the SPC's look like:

```
*BOUNDARY
8,1,1,0.
10,1,2,0.
7,3,3,-1.
```

the fields look like:

$$\text{nodeboun} = \begin{Bmatrix} 8 \\ 10 \\ 10 \\ 7 \end{Bmatrix}, \text{ndirboun} = \begin{Bmatrix} 1 \\ 1 \\ 2 \\ 3 \end{Bmatrix}, \text{xboun} = \begin{Bmatrix} 0. \\ 0. \\ 0. \\ -1. \end{Bmatrix} \quad (898)$$

$$\text{typeboun} = \begin{Bmatrix} B \\ B \\ B \\ B \end{Bmatrix}, \text{ikboun} = \begin{Bmatrix} 45 \\ 50 \\ 64 \\ 65 \end{Bmatrix}, \text{ilboun} = \begin{Bmatrix} 4 \\ 1 \\ 2 \\ 3 \end{Bmatrix}. \quad (899)$$

and nboun=4.

Finally, the following one-dimensional fields are also used:

- nodebounold: contains the node numbers of the SPC's at the end of the last step
- ndirbounold: contains the directions of the SPC's at the end of the last step
- xbounold: contains the values of the SPC's at the end of the last step, or, if this is the first step, zero values.

- `xbounact`: contains the values of the SPC's at the end of the present increment, or, for linear calculations, at the end of the present step. The field `xbounact` is derived from the fields `xbounold` and `xboun` by use of the present time and/or amplitude information. How this is done depends on the procedure and is explained later on.
- `xbounini`: contains the values of the SPC's at the end of the last increment, or, if this is the first increment in the first step, zero's. This field is used for nonlinear calculations only.

Notice that among the boundary conditions SPC's are somewhat special. They are sometimes called geometric boundary conditions to distinguish them from the natural boundary conditions such as the application of a concentrated or distributed load. To remove a natural boundary condition, just set it to zero. This is not true for geometric boundary conditions: by setting a SPC to zero, the corresponding node is fixed in space which usually does not correspond to what one understands by removing the SPC, i.e. free unconstrained motion of the node. Therefore, to remove a SPC the option `OP=NEW` must be specified on the `*BOUNDARY` keyword card. This removes ALL SPC constraints. Then, the constraints which the user does not wish to remove must be redefined. Depending on the procedure (`*STATIC`, `*DYNAMIC...`), the change of SPC's is applied in a linear way. This means that the old SPC information must be kept to establish this linear change. That's why the fields `nodebounold` and `ndirbounold` are introduced. The relationship between the old and new SPC's is established in subroutine `spcmatch`, called from `ccx.2.21.c`.

10.2.2 Homogeneous linear equations

Homogeneous linear equations are of the form

$$a_1 u_{i_1} + a_2 u_{i_2} + \dots + a_n u_{i_n} = 0. \quad (900)$$

The variable n can be an arbitrary integer, i.e. the linear equation can contain arbitrarily many terms. To store these equations (also called MPC's) the one-dimensional field `ipompc` and the two-dimensional field `nodempc`, which contains three columns, are used. For MPC i , row i in field `ipompc` contains the row in field `nodempc` where the definition of MPC i starts: if $ipompc(i) = j$ then the degree of freedom of the first term of the MPC corresponds to direction $nodempc(j, 2)$ in node $nodempc(j, 1)$. The coefficient of this term is stored in $coefmpc(j)$. The value of $nodempc(j, 3)$ is the row in field `nodempc` with the information of the next term in the MPC. This continues until $nodempc(k, 3) = 0$ which means that the term in row k of field `nodempc` is the last term of MPC i .

For example, consider the following MPC:

$$5.u_1(10) + 3.u_1(147) + 4.5u_3(58) = 0. \quad (901)$$

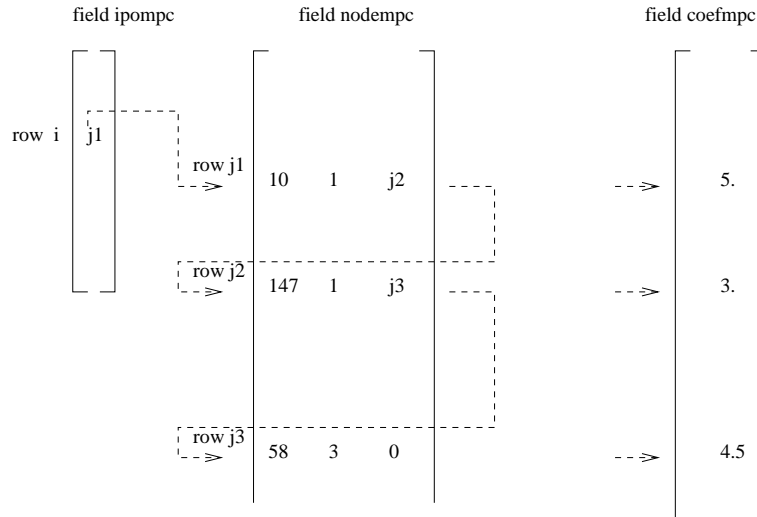

Figure 167: Example of the storage of a linear equation

where $u_1(10)$ stands for the displacement in global x-direction of node number 10, similar for the other terms. Assume this MPC is equation number i . Then, the storage of this equation could look like in Figure 167.

The first term in a MPC is special in that it is considered to be the dependent term. In the finite element calculations the degree of freedom corresponding to such a dependent term is written as a function of the other terms and is removed from the system of equations. Therefore, no other constraint can be applied to the DOF of a dependent term. The DOF's of the dependent terms of MPC's are catalogued in a similar way as those corresponding to SPC's. To this end, a one-dimensional field `ikmpc` is used containing the dependent degrees of freedom in numerical order, and a one-dimensional field `ilmpc` containing the corresponding MPC number. The meaning of these fields is completely analogous to `ikboun` and `ilboun` and the reader is referred to the previous section for details.

In addition, MPC's are labeled. The label of MPC i is stored in `labmpc(i)`. This is a one-dimensional field consisting of character words of length 20 (in FORTRAN: `character*20`). The label is used to characterize the kind of MPC. Right now, the following kinds are used:

- CYCLIC: denotes a cyclic symmetry constraint
- MEANROT: denotes a mean rotation constraint
- PLANE: denotes a plane constraint
- PRETENSION: pretension SPC expressing the pretension condition
- RIGID: denotes a rigid body constraint

- STRAIGHT: denotes a straight constraint
- SUBCYCLIC: denotes a linear MPC some terms of which are part of a cyclic symmetry constraint
- THERMALPRET: thermal boundary condition in the newly created nodes in a pretension section; this is necessary for purely mechanical calculations.

The MEANROT, PLANE and STRAIGHT MPC's are selected by the *MPC keyword card, a RIGID MPC is triggered by the *RIGID BODY keyword card, and a CYCLIC MPC by the *CYCLIC SYMMETRY MODEL card. A SUBCYCLIC MPC is not triggered explicitly by the user, it is determined internally in the program.

Notice that non-homogeneous MPC's can be reduced to homogeneous ones by introducing a new degree of freedom (introduce a new fictitious node) and assigning the inhomogeneous term to it by means of a SPC. Nonlinear MPC's can be transformed in linear MPC's by linearizing them [23]. In CalculiX this is currently done for PLANE MPC's, STRAIGHT MPC's, USER MPC's and RIGID BODY definitions. Notice that SPC's in local coordinates reduce to linear MPC's.

Finally, there is the variable icascade. It is meant to check whether the MPC's changed since the last iteration. This can occur if nonlinear MPC's apply (e.g. a coefficient is at times zero and at other times not zero) or under contact conditions. This is not covered yet. Up to now, icascade is assumed to take the value zero, i.e. the MPC's are not supposed to change from iteration to iteration. (to be continued)

10.2.3 Concentrated loads

Concentrated loads are defined by the keyword card *CLOAD. The internal structure to store concentrated loads is very similar to the one for SPC's, only a lot simpler. The corresponding one-dimensional field for nodeboun, ndirboun, xboun, iamboun, ikboun and ilboun are nodeforc, ndirforc, xforc, iamforc, ikforc and ilforc. The actual number of concentrated loads is nforc, an estimated upper bound (calculated in subroutine allocation.f) is nforc.. The field xforcold and xforcact are the equivalent of xbounold and xbounact, respectively. There is no equivalent to nodebounold, ndirbounold, xbounini and typeboun. These fields are not needed. Indeed, if the option OP=NEW is specified on a *CLOAD card, all values in xboun are set to zero, but the entries in nodeforc and ndirforc remain unchanged. Notice that DOF zero (heat transfer calculations) has the meaning of concentrated heat source.

10.2.4 Facial distributed loads

The field architecture discussed here applies to loads on element faces and heat sources per unit of mass. Consequently, it is used for the following keyword cards:

- *DFLUX: S and BF load labels
- *DLOAD: P load labels
- *FILM: F load labels
- *RADIATE: R load labels
- *TRANSFORMF: T load labels. This label only applies to CFD-calculations, for which transformations are applied to element faces (and not to nodes as for others types of calculations).

It does not apply to gravity and centrifugal loads. These are treated separately.

The two-dimensional integer field `nelemload` contains two columns and as many rows as there are distributed loads. Its first column contains the element number the load applies to. Its second column is only used for forced convection in which case it contains the fluid node number the element exchanges heat with. The load label is stored in the one-dimensional field `soload` (maximum 20 characters per label). The two-dimensional field `xload` contains two columns and again as many rows as there are distributed loads. For *DFLUX and *DLOAD the first column contains the nominal loading value, the second column is not used. For *FILM and *RADIATE loads the first column contains the nominal film coefficient and the emissivity, respectively, and the second column contains the sink temperature. For forced convection, cavity radiation and non uniform loads some of the above variables are calculated during the program execution and the predefined values in the input deck are not used. The nominal loading values can be changed by defining an amplitude. The number of the amplitude (in the order of the input deck) is stored in the one-dimensional field `iamload`. Based on the actual time the actual load is calculated from the nominal value and the amplitude, if any. It is stored in the one-dimensional field `xloadact`.

In the subroutine `calinput.f`, the distributed loads are ordered according to the element number they apply to. Accordingly, the first load definition in the input deck does not necessarily correspond to the first row in fields `nelemload`, `xload`, `iamload`, `xloadact` and `soload`.

As an example, assume the following distributed loads:

```
*DLOAD
10,P3,8.3
*FILM
6,F4,273.,10.
12,F4FC,20,5.
```

then the loading fields will look like:

$$\text{nelemload} = \begin{bmatrix} 6 & 0 \\ 10 & 0 \\ 12 & 20 \end{bmatrix}, \text{xload} = \begin{bmatrix} 10. & 273. \\ 8.3 & 0. \\ 5. & 0. \end{bmatrix}. \quad (902)$$

$$\text{sideload} = \begin{Bmatrix} F4 \\ P3 \\ F4FC \end{Bmatrix}, \text{iamload} = \begin{Bmatrix} 0 \\ 0 \\ 0 \end{Bmatrix}. \quad (903)$$

10.2.5 Mechanical body loads

The field architecture discussed here applies to centrifugal loads and gravity loads. Consequently, it is used for the *DLOAD card with the following labels:

- CENTRIF: centrifugal load
- GRAV: gravity load with known gravity vector
- NEWTON: generalized gravity

The two-dimensional integer field *ibody* contains three columns and as many rows as there are body loads. Its first column contains a code identifying the kind of load:

- 1 = centrifugal load
- 2 = gravity load with known gravity vector
- 3 = generalized gravity

Its second column contains the number of the amplitude to be applied, if any. The third column contains the load case. This is only important for steady state dynamics calculations with harmonic loading. The default value is 1 and means that the loading is real (in-phase); if the value is 2 the loading is imaginary (out-of-phase). The element number or element set, for which the load is defined is stored in the one-dimensional character field *cbody*. It contains as many entries as there are body loads. The nominal value of the body load is stored in the first column of field *xbody*. This is a two-dimensional field containing 7 columns and as many rows as there are body loads. The second to fourth column is used to store a point on the centrifugal axis for centrifugal loads and the normalized gravity vector for gravity loading. If the gravity vector is not known and has to be determined by the mass distribution in the structure (also called generalized gravity) columns two to seven remain undefined. This also applies to columns five to seven for non-generalized gravity loading. For centrifugal loading columns five to seven of field *xbody* contain a normalized vector on the centrifugal axis.

Based on the actual time the actual body load is calculated from the nominal value and the amplitude, if any. It is stored in the first column of field *xbodyact*. Columns two to seven of *xbodyact* are identical to the corresponding columns of *xbody*.

The body loads are not stored in the order in which they are defined in the input deck. Rather, they are ordered in alphabetical order according to

the element number or element set name they apply to. An element number is interpreted as a character.

As an example, assume the following body loads:

```
*DLOAD
Ea11,CENTRIF,1.E8,0.,0.,0.,1.,0.,0.
8,GRAV,9810.,0.,0.,-1.
E1,NEWTON
```

then the loading fields will look like:

$$\text{ibody} = \begin{bmatrix} 2 & 0 & 1 \\ 3 & 0 & 1 \\ 1 & 0 & 1 \end{bmatrix}, \text{cbody} = \begin{Bmatrix} 8 \\ E1 \\ Ea11 \end{Bmatrix}, \quad (904)$$

$$\text{xbody} = \begin{bmatrix} 9810. & 0. & 0. & -1. & 0. & 0. & 0. \\ 0. & 0. & 0. & 0. & 0. & 0. & 0. \\ 1.E8 & 0. & 0. & 0. & 1. & 0. & 0. \end{bmatrix}. \quad (905)$$

10.2.6 Distributing coupling loads

Distributing coupling loads are used if one wants to distribute a concentrated force and moment in a reference node across a complete surface. A typical application is the definition of a torque at the end of a (nearly) axisymmetric structure. You do not really know the force in each node, you just know the global value of the torque and the facial surface on which you would like to apply it. CalculiX calculates the corresponding forces in each node of the surface. For the theory the reader is referred to Section 6.7.3.

A distributed coupling is only active if a force was defined in the reference node (using a *CLOAD card) on a *COUPLING card in a direction defined underneath a *DISTRIBUTING card (which has to follow immediately underneath the *COUPLING card). The possible directions are 1 to 3 for forces (1 corresponds to a force along the x-axis etc.; this axis is local if the ORIENTATION parameter was used on the *COUPLING card, else it is global) and 4 to 6 for moments (4 corresponds to a moment about the x-axis etc.; this axis is local if the ORIENTATION parameter was used on the *COUPLING card, else it is global).

As soon as a *COUPLING card is detected followed by a *DISTRIBUTING card, the coupling surface is analyzed, its center of gravity is determined using area-defined weights and the constraints expressing the force in a given global direction in a concrete node of the coupling surface are stored in field coeffc(0..6,*). For force constraint i the information is stored as follows:

- coeffc(0,i): node and global degree of freedom (dof) to which this constraint applies in the form $10*(\text{node}-1)+\text{dof}$
- coeffc(1,i): force in that node and direction for a unit force in local x-direction in the reference node

- `coeffc(2,i)`: force in that node and direction for a unit force in local y-direction in the reference node
- `coeffc(3,i)`: force in that node and direction for a unit force in local z-direction in the reference node
- `coeffc(4,i)`: force in that node and direction for a unit moment about the local x-direction in the reference node
- `coeffc(5,i)`: force in that node and direction for a unit moment about the local y-direction in the reference node
- `coeffc(6,i)`: force in that node and direction for a unit moment about the local z-direction in the reference node

The number of such constraints (which may correspond to several distributing coupling definitions, indeed, the user may define more than one `*COUPLING` card followed by a `*DISTRIBUTING` card) is `nfc`. They are stored at the beginning of the calculation and may be addressed in any step.

In addition, for each degree of freedom defined underneath the `*DISTRIBUTING` card an entry in fields `ikdc(*)` and `edc(12,*)` is generated. Notice that the translational degrees of freedom are always active, irrespective whether the user has selected them underneath the `*DISTRIBUTING` card or not. The total number of distributing couplings is `ndc`. Each distributed coupling `i` corresponds to a (local or global depending on the presence of parameter `ORIENTATION` on the `*COUPLING` card) reference direction in the reference node and is stored in `ikdc(i)` in the form `8*(refnode-1)+refdir`. This field is sorted in ascending order. The corresponding entries `edc(1..12,i)` correspond to:

- 1: the first force constraint in field `coeffc` for this distributing coupling +0.5
- 2: the last force constraint + 0.5
- 3: the number of the orientation on the `*COUPLING` card, if any (default 0) +0.5
- 4-6: local unit vector \mathbf{e}_1 of the coupling surface (in-surface)
- 7-9: local unit vector \mathbf{e}_2 of the coupling surface (in-surface)
- 10-12: local unit vector \mathbf{e}_3 of the coupling surface (orthogonal to the surface)

Also this information is stored at the beginning of the calculation.

Now, for each definition of a concentrated load in a node and direction, a check is performed by using field `ikdc` whether this node and direction correspond to a reference node and direction of a distributing coupling. If so, field `edc` indicates which force constraints are to be used and whether the force has

to be projected because an orientation was defined. So at the time of reading the concentrated loads (in `clouds.f`) all point loads are calculated in the nodes of the coupling surface. Notice that the same rules apply as for `*CLOAD`: at the first occurrence in a step any previous load in that node and direction is replaced, at all further occurrences within the same step the value are added. It is not recommended to apply concentrated loads in any node belonging to a coupling surface apart from the ones by applying forces in the reference node.

10.2.7 Sets

A set is used to group nodes or elements. In the future, it will also be used to define surface based on nodes and surfaces based on element faces. A set `i` is characterized by its name `set(i)` and two pointers `istartset(i)` and `iendset(i)` pointing to entries in the one-dimensional field `ialset`. The name `set(i)` consists of at most 81 characters, the first eighty of which can be defined by the user. After the last user-defined character the character 'N' is appended for a node set and 'E' for an element set. For surfaces, which are internally treated as sets, these characters are 'S' for nodal surfaces and 'T' for element facial surfaces. The extra character allows the user to choose identical names for node and elements sets and/or surfaces. The nodes or elements a set consists of are stored in field `ialset` between row `istartset(i)` and row `iendset(i)`. If the parameter `GENERATE` was not used in the set definition, the entries in `ialset` are simply the node or element numbers. If `GENERATE` is used, e.g.

```
*NSET,NSET=N1,GENERATE
20,24
```

the start number, the end number and increment preceded by a minus sign are stored, in that order. Accordingly, for the above example: 20,24,-1. Consequently, a negative number in field `ialset` always points to an increment to be used between the two preceding entries. For example, if the only two sets are defined by:

```
*NSET,NSET=N1,GENERATE
20,24
*NSET,NSET=N1
383,402,883
*ELSET,ELSET=N1,GENERATE
3,8
```

the fields `set`, `istartset`, `iendset` and `ialset` read:

$$\text{set} = \begin{Bmatrix} N1N \\ N1E \end{Bmatrix}, \text{istartset} = \begin{Bmatrix} 1 \\ 7 \end{Bmatrix}, \text{iendset} = \begin{Bmatrix} 6 \\ 9 \end{Bmatrix}, \text{ialset} = \begin{Bmatrix} 20 \\ 24 \\ -1 \\ 383 \\ 402 \\ 883 \\ 3 \\ 8 \\ -1 \end{Bmatrix}. \quad (906)$$

10.2.8 Material description

The size of the fields reserved for material description is governed by the scalars `nmat_`, `nmat`, `ncmat_`, `ntmat_` and `npmat_`. Their meaning:

- `nmat_`: upper estimate of the number of materials
- `nmat`: actual number of materials
- `ncmat_`: maximum number of (hyper)elastic constants at any temperature for any material
- `ntmat_`: maximum number of temperature data points for any material property for any material
- `npmat_`: maximum number of stress-strain data points for any temperature for any material for any type of hardening (isotropic or kinematic)

An elastic material is described by the two-dimensional integer field `nelcon` and three-dimensional real field `elcon`. For material `i`, `nelcon(1,i)` contains for linear elastic materials the number of elastic constants. For hyperelastic materials and the elastic regime of viscoplastic materials `nelcon(1,i)` contains an integer code uniquely identifying the material. The code reads as follows:

- -1: Arruda-Boyce
- -2: Mooney-Rivlin
- -3: Neo-Hooke
- -4: Ogden (N=1)
- -5: Ogden (N=2)
- -6: Ogden (N=3)
- -7: Polynomial (N=1)
- -8: Polynomial (N=2)

- -9: Polynomial (N=3)
- -10: Reduced Polynomial (N=1)
- -11: Reduced Polynomial (N=2)
- -12: Reduced Polynomial (N=3)
- -13: Van der Waals (not implemented yet)
- -14: Yeoh
- -15: Hyperfoam (N=1)
- -16: Hyperfoam (N=2)
- -17: Hyperfoam (N=3)
- -50: deformation plasticity
- -51: incremental plasticity (no viscosity)
- -52: viscoplasticity
- < -100: user material routine with -kode-100 user defined constants with keyword *USER MATERIAL

Notice that elconloc is also used to store

- user-defined constants for user-defined materials
- the creep constants for isotropic viscoplastic materials (after the two elastic constants).

Entry nelcon(2,i) contains the number of temperature points for material i.

The field elcon is used for the storage of the elastic constants: elcon(0,j,i) contains the temperature at the (hyper)elastic temperature point j of material i, elcon(k,j,i) contains the (hyper)elastic constant k at temperature point j of material i. Notice that the first index of field elcon starts at zero.

Suppose only one material is defined:

```
*MATERIAL,NAME=EL
*ELASTIC
210000.,.3,293.
200000.,.29,393.
180000.,.27,493.
```

then the fields nelcon and elcon look like:

$$\text{nelcon} = \begin{bmatrix} 2 & 3 \end{bmatrix}, \text{elcon}(*,*,1) = \begin{bmatrix} 293. & 393. & 493. \\ 210000. & 200000. & 180000 \\ .3 & .29 & .27 \end{bmatrix}, \quad (907)$$

and $nmat=1$, $ntmat_=3$, $ncmat_=2$.

Other material properties are stored in a very similar way. The expansion coefficients are stored in fields $nalcon$ and $alcon$, the conductivity coefficients in fields $ncocon$ and $cocon$. The density and specific heat are stored in fields $nrhcon$, $rhcon$, $nshcon$ and $shcon$, respectively. Furthermore, the specific gas constant is also stored in $shcon$. The fields $nrhcon$ and $nshcon$ are only one-dimensional, since there is only one density and one specific heat constant per temperature per material (the specific gas constant is temperature independent).

The isotropic hardening curves for viscoplastic materials are stored in the two-dimensional integer field $nplicon$ and the three-dimensional real field $plicon$. The entry $nplicon(0,i)$ contains the number of temperature data points for the isotropic hardening definition of material i , whereas $nplicon(j,i)$ contains the number of stress-strain data points at temperature point j of material i . Entry $plicon(2*k-1,j,i)$ contains the stress corresponding to stress-plastic strain data point k at temperature data point j of material i , $plicon(2*k,j,i)$ contains the plastic strain corresponding to stress-plastic strain data point k at temperature data point j of material i . Similar definitions apply for the kinematic hardening curves stored in $nplkcon$ and $plkcon$.

10.3 Expansion of the one-dimensional and two-dimensional elements

Typical one-dimensional elements are beams, typical two-dimensional elements are shells, plane stress elements, plane strain elements and axisymmetric elements. Their dimension in thickness direction (for two-dimensional elements) or orthogonal to their axis (for beam elements) is much smaller than in the other directions. In CalculiX these elements are expanded to volume elements. Only quadratic shape functions are accepted.

The expansion of the elements requires several steps:

- cataloguing the elements belonging to one and the same node
- calculating the normals in the nodes
- generating the expanded volume elements
- taking care of the connection of 1D/2D elements with genuine 3D elements
- applying the SPC's to the expanded structure
- applying the MPC's to the expanded structure
- applying the temperatures and temperature gradients
- applying nodal forces to the expanded structure

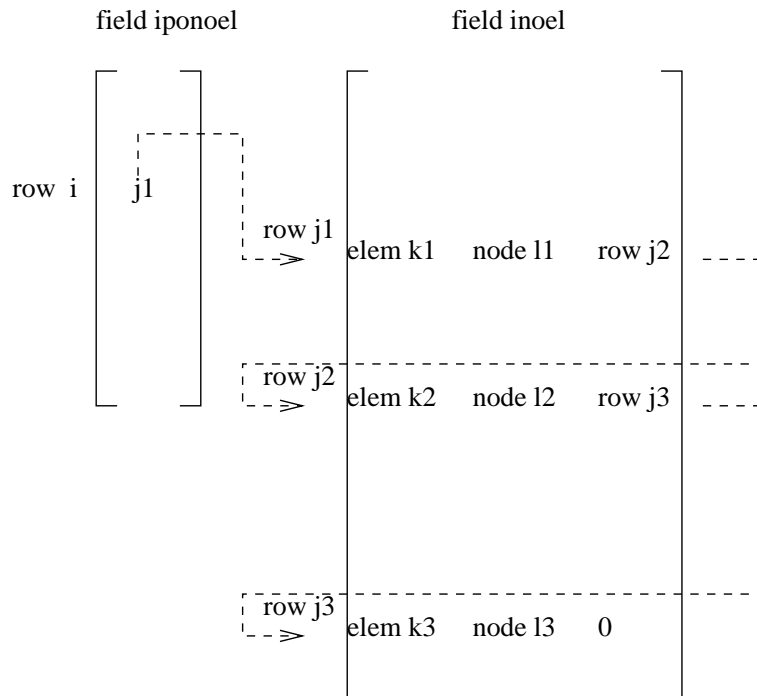

Figure 168: Structures to store all elements to which a given node belongs

10.3.1 Cataloguing the elements belonging to a given node

A node can belong to several elements of different types. The structure to store this dependence consists of two fields: a one-dimensional field `iponoel` and a two-dimensional field `inoel`. For node i the value $j1 = \text{iponoel}(i)$ points to row $j1$ in field `inoel` containing in its first column the number $k1$ of an element to which node i belongs, in its second column the local number $l1$ which node i assumes in the topology of the element and in its third column the row number $j2$ in field `inoel` where another element to which node i belongs is listed. If no further element exists, this entry is zero (Figure 168).

Notice that this structure allows the node to belong to totally different element types, e.g. a beam element, a shell element and a plane stress element.

10.3.2 Calculating the normals in the nodes

The calculation of the normals (subroutine "gen3dnor.f") in the nodes is performed using a rather complicated algorithm explained in Sections 6.2.14 and 6.2.33. In a node several normals can exist, think for instance of a node on the fold of a roof. Each normal is used to perform an expansion, i.e. in a node with two normals two expansions are performed which partially overlap (Figure 70). Theoretically, as many expansions can be needed as there are elements to

which the node belongs to. Therefore, to store the expansions and the normals a structure is used similar to the field `kon` to store the topology of the elements.

The field `kon` is a one-dimensional field containing the topology of all elements, one after the other. The entry `ipkon(i)` points to the location in field `kon` just before the start of the topology of element `i`, i.e. the first node of element `i` is located at position `ipkon(i)+1` in field `kon`, the last node at position `ipkon(i)+numnod`, where `numnod` is the number of nodes of the element, e.g. 20 for a 20-node element. Thus, local position `m` of element `j` corresponds to global node number `kon(ipkon(j)+m)`. Now, a similar structure is used for the normals and nodes of the expansions since these variables are linked to a local position within an element rather than to a global node number. To this end the two-dimensional field `iponor` and one-dimensional fields `xnor` and `knor` are used.

The entry `iponor(1,ipkon(j)+m)` points to the location of the normal at local position `m` of element `j` within field `xnor`, i.e. the three components of the normal are stored in `xnor(iponor(1,ipkon(j)+m)+1)`, `xnor(iponor(1,ipkon(j)+m)+2)` and `xnor(iponor(1,ipkon(j)+m)+3)`. In the same way the entry `iponor(2,ipkon(j)+m)` points to the location of the new nodes of the expansion at local position `m` of element `j` within field `knor`, i.e. the three new node numbers are stored at `knor(iponor(2,ipkon(j)+m)+n)`, $n=1,2,3$. The order of the node numbers is illustrated in Figure 69. This applies to the expansion of two-dimensional elements. For the expansion of beam elements `xnor` contains six entries: three entries for unit vector 1 and three entries for unit vector 2 (Figure 73), i.e. `xnor(iponor(1,ipkon(j)+m)+1), ..., xnor(iponor(1,ipkon(j)+m)+6)`. Since the expansion of a beam element leads to 8 extra nodes (Figure 74) 8 entries are provided in field `knor`. The field `xnor` is initialized with the values from keyword card `*NORMAL`.

The procedure runs as follows: for a node `i` all 2D elements to which the node belongs are determined. Then, the normals on these elements are determined using the procedure explained in Section 6.2.14 starting with the normals predefined by a `*NORMAL` keyword card. Notice that extra normals are also defined at thickness discontinuities, offset discontinuities or element type changes (e.g. a plane stress element adjacent to a shell element). Therefore, this step is more about how many different expansions are needed rather than different normals: if, for instance the thickness of a flat plate changes discontinuously, two different expansions are needed at the discontinuity nodes although the normal does not change. Next, all beam elements to which node `i` belongs are determined and normals are determined in a similar way. For each normal appropriate nodes are generated for the expansion (three for 2D elements, eight for 1D elements). If overall only one normal suffices, no knot exists and no rigid body needs to be defined, unless the rotational degrees of freedom in the node are constrained or moments applied. If more than one normal ensues or the rotational degrees of freedom are addressed by the user in any way, a rigid body is generated. In a rigid body definition all expansion nodes of shells and beam participate, for plane stress, plane strain or axisymmetric elements only the midside nodes take part.

Caution is due to the fact that the entries in the fields `kon` and `iponor` do not correspond to the same nodes any more after leaving `gen3delem.f`. This is because the original element topology of the elements is shifted in field `kon` to allow the storage of the expanded topology. For instance, suppose that element `i` is a S8 element. Upon entering `gen3delem.f` the topology of this element is stored in entries $(kon(ipkon(i)+j,j=1,8))$ and soon afterwards the pointers to the expanded nodes and normals are stored in $(ipkon(ipkon(i)+j,j=1,8))$. However, upon leaving `gen3delem.f` the original topology is shifted to $(kon(ipkon(i)+20+j,j=1,8))$ (a S8 element is expanded into a 20-node element) and the expanded topology is stored in $(kon(ipkon(i)+j),j=1,20)$. Field `iponor`, however, is not changed.

10.3.3 Expanding the 1D and 2D elements

The 1D elements are expanded in subroutine “`gen3dfrom1d.f`”, the 2D elements in “`gen3dfrom2d.f`”.

Expanding the 1D elements involves changing the topology of the element from a 3-node 1D element to a 20-node 3D element using the expanded nodes stored in field `knor`. Notice that the old node numbers are not used, so at this stage conditions applied to the old node numbers are not yet transferred to the new nodes. To calculate the position of the new nodes the unit vectors 1 and 2, stored in `xnor`, are used together with the information defined by `*BEAM SECTION` on the dimensions and the form of the cross section. Both rectangular and elliptical cross sections are allowed.

Expanding the 2D elements requires the thickening of the elements using the expanded node numbers stored in `knor` and the normals stored in `xnor`. The element numbers remain, only the topology changes. Notice that the old node numbers are not used, so at this stage conditions applied to the old node numbers are not yet transferred to the new nodes. Plane strain, plane stress and axisymmetric elements require some additional care: these are special elements taking into account specific geometrical configurations. Remember that 8-node 2D elements are expanded into one layer of 20-node brick elements and 6-node 2D elements into one layer of 15-node brick elements. Plane strain, plane stress and axisymmetric elements are defined in one plane, traditionally the x-y plane. Now, for the expansion into 3D this plane is assumed to correspond to $z=0$. It is the middle plane of the expansion. The elements are expanded half in positive z-direction, half in negative z-direction. Let us call the expanded nodes in positive z-direction the positive-z nodes, the ones in the plane $z=0$ the zero-z nodes and the rest the negative-z nodes. For plane strain the positive-z and negative-z nodes exhibit exactly the same displacements as the zero-z nodes. These conditions are expressed in the form of multiple point constraints, and are also generated in subroutine “`gen3dfrom2d.f`”. These MPC’s greatly reduce the size of the ensuing matrix system. For plane stress elements the positive-z nodes and the negative-z nodes have the same displacements in x- and y-direction as the zero-z nodes. For axisymmetric elements the positive-z nodes and the negative-z nodes have the same displacements as the zero-z nodes for all directions in cylindrical coordinates. Finally, for plane strain, plane stress

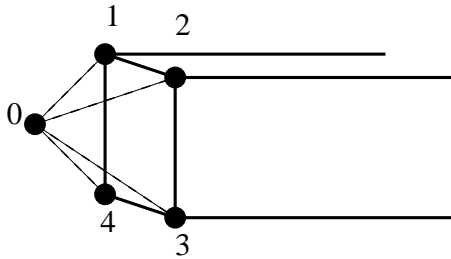

Figure 169: Beam element connection

and axisymmetric elements the displacement in z for the zero- z nodes is zero.

10.3.4 Connecting 1D and 2D elements to 3D elements

The connection of 1D and 2D elements with genuine 3D elements also requires special care and is performed in subroutine “gen3dconnect.f”. Remember that the expanded elements contain new nodes only, so the connection between these elements and 3D elements, as defined by the user in the input deck, is lost. It must be reinstated by creating multiple point constraints. This, however, does not apply to knots. In a knot, an expandable rigid body is defined with the original node as translational node (recall that a knot is defined by a translational, a rotational and an expansion node). Thus, for a knot the connection with the 3D element is guaranteed. What follows applies to nodes in which no knot was defined.

For 1D beam elements the connection is expressed by the equation (see Figure 169 for the node numbers)

$$u_1 + u_2 + u_3 + u_4 - 4u_0 = 0 \quad (908)$$

where u stands for any displacement component (or temperature component for heat transfer calculations), i.e. the above equation actually represents 3 equations for mechanical problems, 1 for heat transfer problems and 4 for thermomechanical problems. Notice that only edge nodes of the beam element are used, therefore it can also be applied to midside nodes of beam elements. It expresses that the displacement in the 3D node is the mean of the displacement in the expanded edge nodes.

For 2D shell elements the connection is expressed by equation (see Figure 170 for the node numbers)

$$u_1 + u_2 - 2u_0 = 0. \quad (909)$$

The same remarks apply as for the beam element.

Finally, for plane strain, plane stress and axisymmetric elements the connection is made according to Figure 171 and equation:

$$u_1 - u_0 = 0. \quad (910)$$

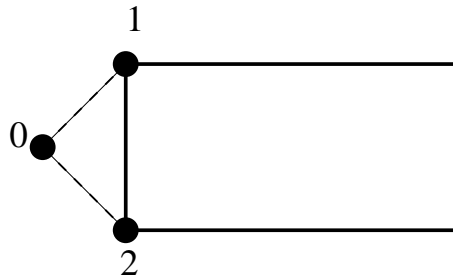

Figure 170: Shell element connection

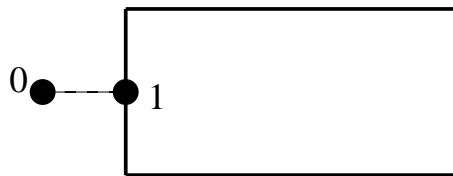

Figure 171: Plane and axisymmetric element connection

Node 1 is the zero- z node of the expanded elements. Although a twenty-node brick element does not use zero- z nodes corresponding to the midside nodes of the original 2D element, they exist and are used in MPC's such as the above equation. The connection is finally established through the combination of the above MPC with the plane strain, plane stress and axisymmetric MPC's linking the zero- z nodes with the negative- z and positive- z nodes.

10.3.5 Applying the SPC's to the expanded structure

Here too, the problem is that the SPC's are applied by the user to the nodes belonging to the original 1D and 2D elements. The expanded nodes, however, have different numbers and a link must be established with the original nodes. This is again performed by multiple point constraints. They are generated in subroutine "gen3dboun.f".

For knots the translational node of the rigid body formulation is the original node number. Consequently, translational SPC's are automatically taken into account. If a rotational SPC is applied, it must be transferred to the rotational node of the knot, e.g. degree of freedom 4 of the original node (rotation about the x -axis) is transformed into degree of freedom 1 of the rotational node.

If no knot is generated in the node to which a translational SPC is applied, the way this node is connected to the newly generated nodes in the expanded elements depends on the type of element. For 1D elements MPC's are generated according to Equation 908 and Figure 169. For 2D shell elements the MPC's correspond to Equation 909 and Figure 170. Finally, for 2D plane and axisymmetric elements the MPC's correspond to Equation 910 and Figure 171.

The application of a rotational SPC to a node in which no knot is defined is performed by generating a mean rotation MPC (cf. Section 8.7.1) about the rotation axis. The rotation axis can be along a global coordinate direction or along a local one. Contrary to translational SPC's, rotational SPC's in a local coordinate system are not converted into MPC's. Rather, the local rotation axis is taken right away as the axis of the mean rotation.

For the temperature degrees of freedom in heat transfer calculations the MPC's generated in beam and shell nodes in which no knot is defined are not sufficient. Indeed, the MPC only specifies the mean of corner nodes (for beams) or the mean of the upper and lower node (for shells). In practice, this corresponds to any bilinear (for beams) or linear (for shells) function across the cross section. In CalculiX, it is not possible to specify this gradient, so a constant function is defined. This is done by assigning the temperature SPC to nodes 2, 3 and 4 (for beams, Equation 908) and to node 2 (for shells, Equation 909).

10.3.6 Applying the MPC's to the expanded structure

The procedure applied here (and coded in subroutine "gen3dmpc.f") is similar to the one in the previous section. The problem consists again of connecting the nodes to which the MPC is applied with the newly generated nodes of the expansion. Each term in the MPC is considered separately. If a knot is defined in the node of the term at stake, nothing needs to be done if a translational degree of freedom is addressed, whereas for a rotational degree of freedom the node is replaced by the rotational node of the knot. If no knot is defined, MPC's satisfying Equation 908 are generated for 1D elements, MPC's satisfying Equation 909 for 2D shell elements and MPC's described by Equation 910 for plane and axisymmetric elements. For the latter elements only the nodes in the zero-z plane are connected, see Figure 171. No rotational degrees of freedom are allowed in nodes of MPC's in which no knot was created.

10.3.7 Applying temperatures and temperature gradients

Temperatures and temperature gradients applied to 1D and 2D elements are transformed into temperatures in the nodes of the expanded elements. To this end the normals and thickness are used to convert the temperature gradients into temperatures in the 3D elements. This is only needed in mechanical calculations with temperature loading. Indeed, in heat transfer calculations the temperatures are unknown and are not applied. Temperature application to 1D and 2D elements is done in subroutine "gen3dtemp.f".

10.3.8 Applying concentrated forces to the expanded structure

This is similar to the application of SPC's: if a knot is defined in the node nothing is done for applied translational forces. For moments (which can be considered as rotational forces) their values are applied to the rotational node of the knot, i.e. the node number is changed in the force application.

The stresses in the expanded element are at first determined in the integration points (e.g. the Gauss-Kronrod points, cf. Figure 76). Then, they are expanded to the nodes of the element. Consequently, the stresses are available at all 20 nodes of the element in Figure 172. In order to obtain the section force the following local coordinate systems are introduced:

- The local element $\xi - \eta - \zeta$ -system. ξ is along the axis of the beam (from the first node of the element to the last node), ζ is along the user-defined 1-direction of the beam, η corresponds to the minus 2-direction. The 2-direction is defined such that ξ -1-2 corresponds to a positive axis system.
- On the positive face of the beam element (the face corresponding to the last end node of the beam definition, i.e. $\xi = 1$) the positive direction for the section forces, which is denoted by I, II and III in Figure 172 corresponds to the element 1-direction, 2-direction and ξ .
- On the negative face of the beam element the positive direction for the section forces, denoted by I, II and III points in the other direction of the corresponding axes on the positive face (action=reaction).
- The local node numbering within the positive face is labeled by 1 to 8 in small circles and corresponds to a local coordinate system $\xi_l, \eta_l = \zeta, -\eta$ coinciding with the system I-II.
- The local node numbering within the negative face is also labeled by 1 to 8 in small circles and corresponds to a local coordinate system $\xi_l, \eta_l = -\zeta, \eta$.

The system I-II-III in the faces denotes the positive direction of the section forces. The location of the integration points in the corresponding ξ_l, η_l system is obtained from the local element coordinate system $\xi - \eta - \zeta$ through the above face-dependent relationships.

In order to get the section forces the stresses are calculated in the integration points of the positive and negative face by interpolation from the stresses at the nodes belonging to the respective face. The integration point scheme depends on the beam section.

10.4 Contact

10.4.1 Penalty contact

Contact is triggered by the keyword card *CONTACT PAIR. It defines an interaction between a nodal or element face slave surface and a element face master surface. The master surface is triangulated using standard triangulation schemes for the different kind of faces (3-node, 4-node, 6-node or 8-node). This is done in subroutines allocont.f, triangucont.f and trianeighbor.f. This triangulation is a topological one and does not depend on the concrete coordinates. It is performed at the start of nonlinge.c. The resulting triangles are stored in

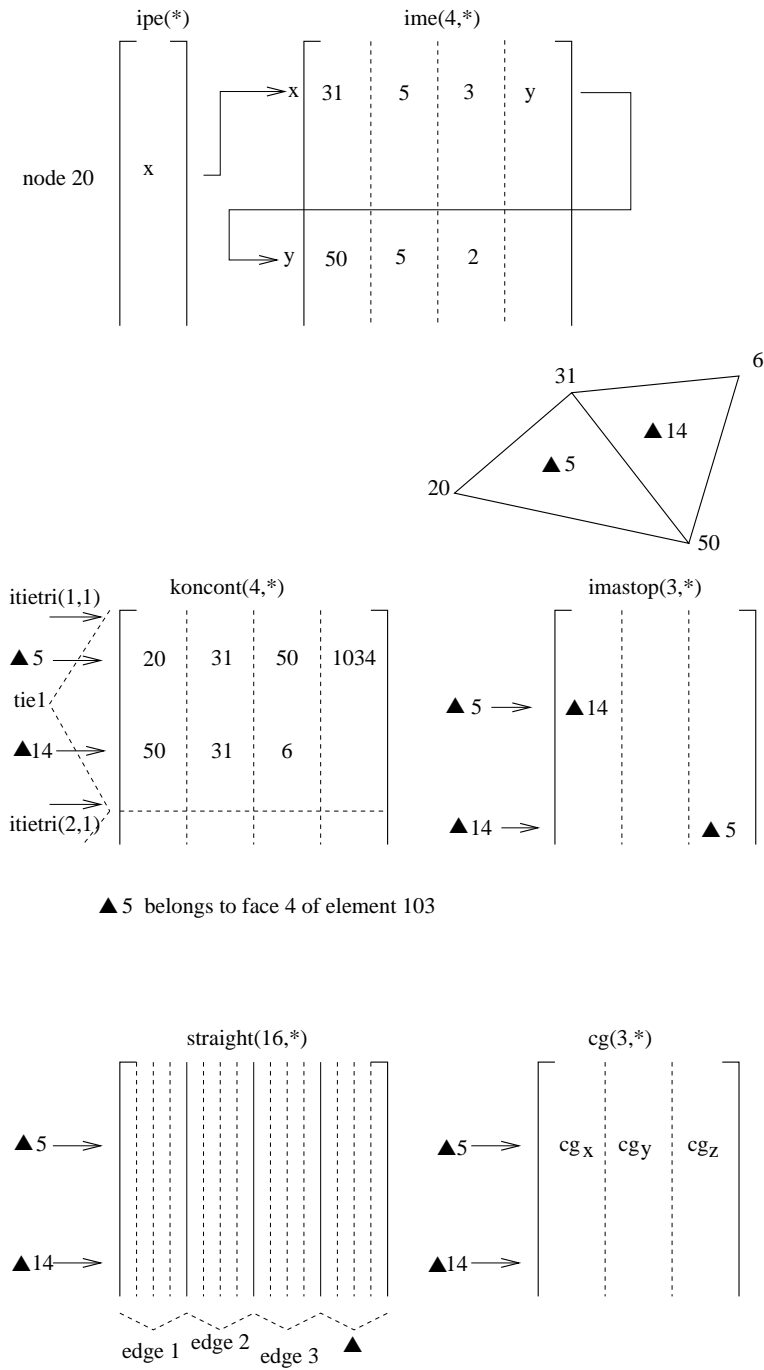

Figure 173: Storage of the triangulation properties

field `koncont` (Figure 173): for triangle i the locations `koncont(1..3,i)` contain the nodes belonging to the triangle, `koncont(4,i)` contains the element face to which the triangle belongs. The element face is characterized by a code consisting of $10 \times (\text{element number}) + \text{face number}$. So the code for face 4 of element 33 is 334. The triangles are stored in the order of the contact tie constraints they belong to. For tie constraint i the location of the first triangle in field `koncont` is given by `itietri(1,i)`, the location of the last one by `itietri(2,i)`.

The triangulation of the master surfaces allows for fast algorithms to determine the master face opposite of a given slave node. To facilitate this search, a field `imastop` is created: `imastop(i,j)` yields for triangle j the triangle opposite of node `koncont(i,j)`. This is the neighboring triangle containing the edge to which node `koncont(i,j)` does not belong. This adjacency information is needed to apply the search algorithms in Section 1.7 of [29]. To facilitate the construction of `imastop` (done in subroutine `trianeighbor.f`), the edges of the triangulation are catalogued by use of two auxiliary fields `ipe(*)` and `ime(4,*)`. An edge is characterized by two nodes i and j , suppose $i < j$. Then, if no other edge was encountered so far for which i was the lowest node, the present edge is stored in `ime(1..4,ipe(i))`, where `ime(1,ipe(i))` contains j , `ime(2,ipe(i))` contains one of the triangles to which the edge belongs, e.g. `t1`, `ime(3,ipe(i))` contains the local position in `koncont(1..3,t1)` of the node belonging to `t1` but not on the edge i - j and `ime(4,ipe(i))` is a pointer to `ime(1..4,ime(4,ipe(i)))` containing any other edge for which i is the lowest node number, else it is zero. For node-to-face penalty contact these auxiliary fields are deleted upon leaving `trianeighbor`. For face-to-face penalty contact they are further used in `slavintpoints.f` and for mortar contact in `slavintmortar.f`.

For further calculations both the slave nodes and the slave surfaces have to be catalogued. In case the slave surface is defined by nodes, the corresponding faces have to be found. To this end, all external faces of the structure are catalogued by fields `ipoface` and `nodface` in subroutine `findsurface.f` (Figure 174). Assuming face $f1$ to contain corner nodes $i < j < k < l$, $f1$ is stored in `nodface(1..5,ipoface(i))`. The entries 1..5 contain: node j , node k , node l , a face label in the form $10 \times \text{element number} + \text{local face number}$ and a pointer to any other face for which i is the lowest node.

The slave nodes are stored in field `islavnode(*)` (Figure 175), tie per tie and sorted in increasing order for each tie separately. `nslavnode(i)` contains the position in `islavnode` before the first slave node of tie i . If $ntie$ is the number of ties, `nslavnode` contains $ntie+1$ entries, in order to mark the end of the field `islavnode` as well. The total number of slave nodes is denoted by `nslavs`. For face-to-face contact the field `clearslavnode` contains the difference between the clearance specified by the user with the keyword card `*CLEARANCE` and the clearance calculated based on the actual coordinates. This field is zero in the absence of the `*CLEARANCE` card. The field `clearini` contains the clearance for each node belonging to the slave face at stake. This information is copied from field `clearslavnode`.

The slave faces are stored in `islavsurf(1..2,*)` (Figure 176 and Figure 177). `islavsurf(1,*)` contains the slave faces, tie per tie (not in any way sorted),

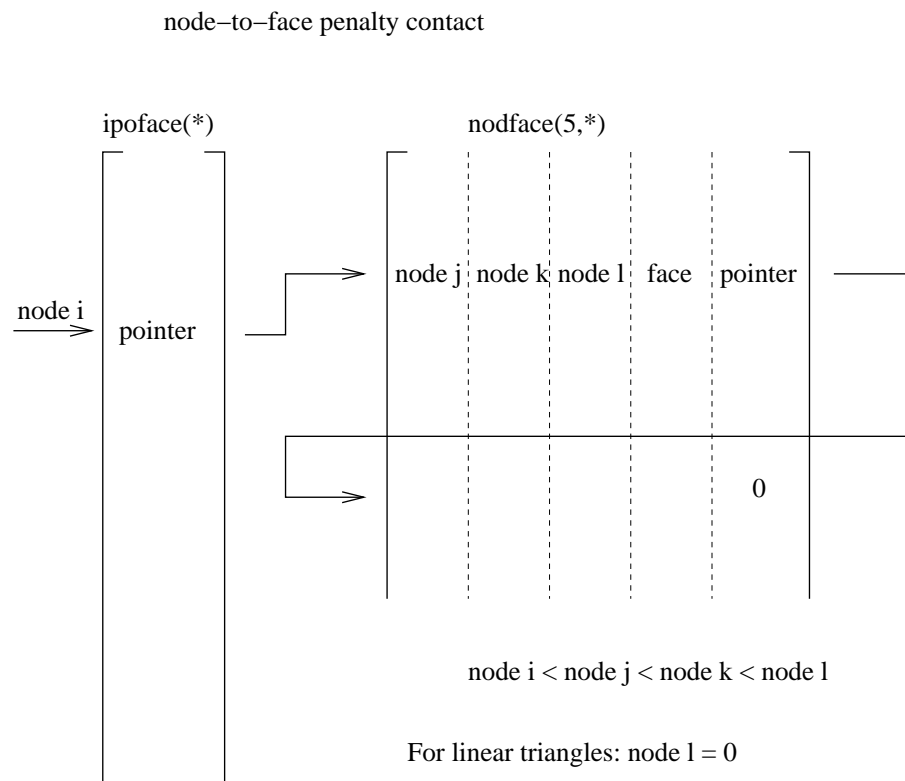

Figure 174: Storage of all faces for the determination of the external faces

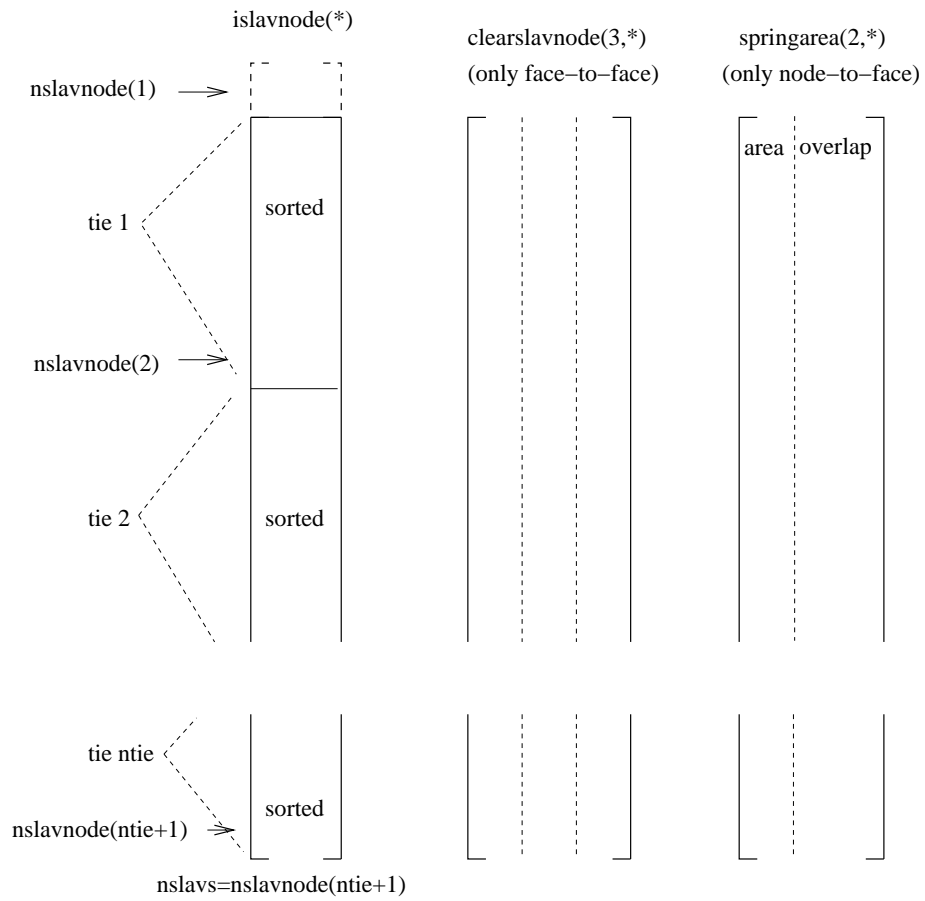

Figure 175: Storage of the slave nodes

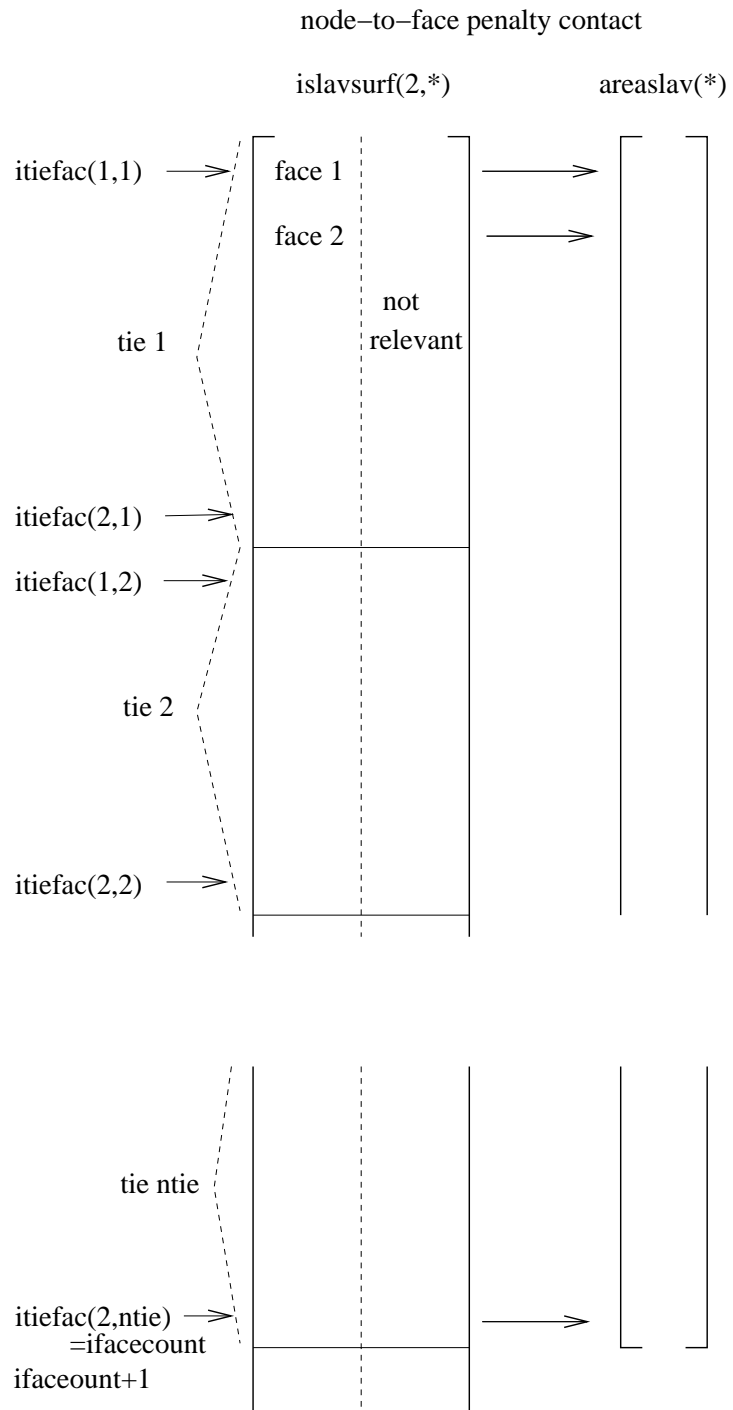

Figure 176: Storage of the slave faces (node-to-face penalty)

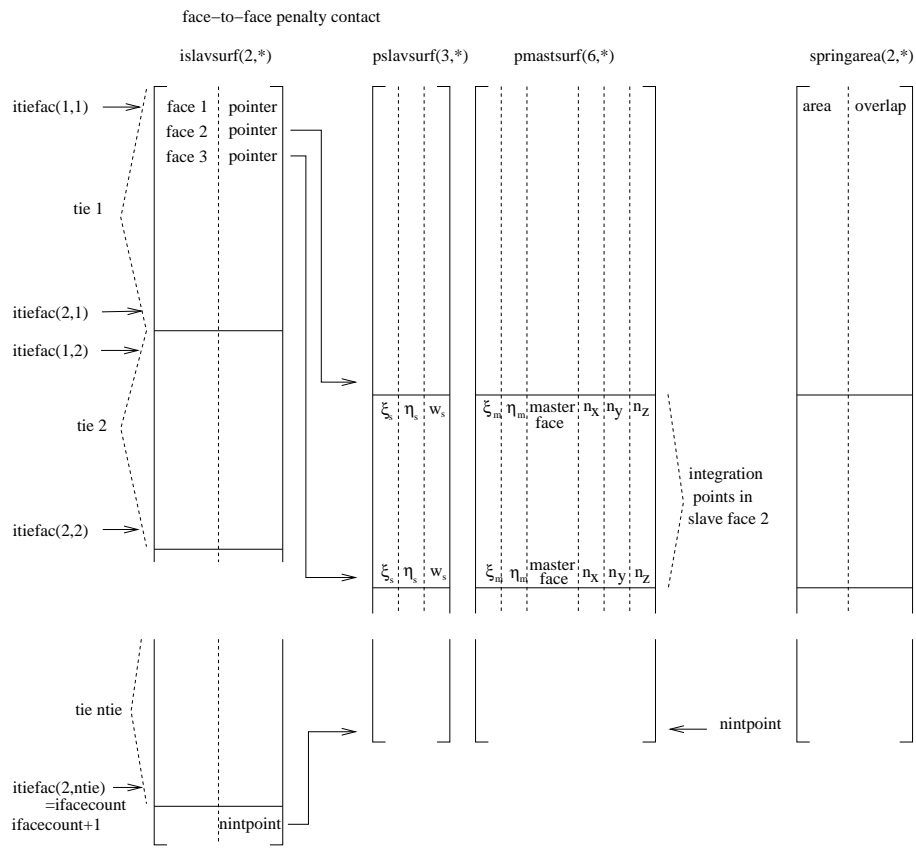

Figure 177: Storage of the slave faces (face-to-face penalty)

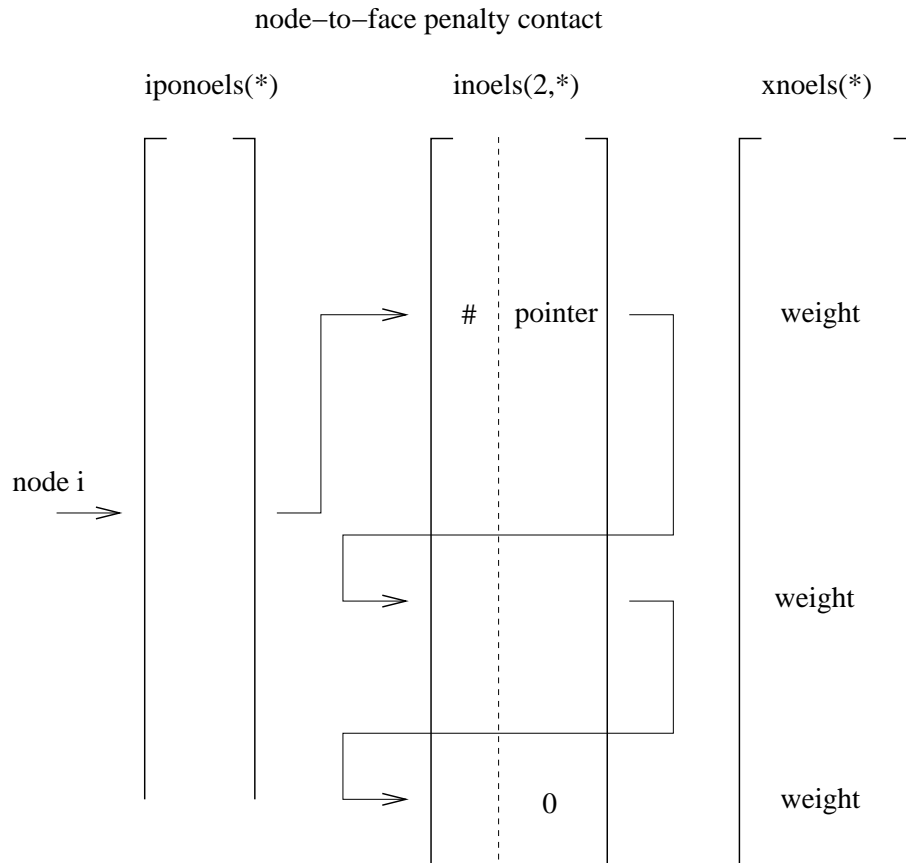

Figure 178: Storage of the slave faces belonging to a given slave node

whereas `islavsurf(2,*)` is an auxiliary field not further needed for node-to-face contact. `itiefac(1,i)` is a pointer into field `islavsurf` marking the first face for tie `i`, `itiefac(2,i)` points to the last face. The total number of slave faces is `ifacecount`. The area of the slave faces is stored in a corresponding field `areaslav`. For face-to-face penalty contact the second column of `islavsurf` is used as a pointer to locations in field `pslavsurf`, preceding the integration points in the face (local coordinates and weights). If for a given integration point in the slave face an opposite master face is found, the local coordinates, the label of the master face and the local normal to the master face are stored in field `pmastsurf`.

For the purpose of calculating the area corresponding to a given slave node, the fields `iponoels` and `inoels` are used (Figure 178). For a slave node `i`, the value `iponoels(i)` points towards an entry `inoels(1..3,iponoels(i))` containing the

position within field `islavsurf(1,*)` of a face to which node `i` belongs and an entry `inoels(2,iponoels(i))` pointing to any other faces to which node `i` belongs. Field `xnoels` contains the weight of the node within the face. This information is gathered in subroutine `inicont.c`.

The master nodes are catalogued in field `imastnode` in the same way that the slave nodes are stored in `islavnode` (Figure 179). The master nodes are stored tie per tie, within each tie they are sorted in ascending order. For tie `i` `nmastnode(i)` points towards the location in `imastnode` immediately before the master node with the smallest number within tie `i`, `nmastnode(i)` points towards the master node within tie `i` with the largest number. The size of `imastnode` is `nmastnode(nty+1)`, where `nty` is the number of ties. In each iteration and/or increment the topological information of each master triangle is complemented by geometrical information consisting of the center of gravity (in field `cg`) and the equations of the triangle plane and the planes quasi-perpendicular to the triangle and containing its edges. For triangle `i` the coordinates of the center of gravity are stored in `cg(1..3,i)`. The coefficients of the equation of the plane orthogonal to the triangle and containing the first edge are stored in `straight(1..4,i)`. The first edge is defined as the edge through nodes `koncont(1,i)` and `koncont(2,i)`. Similar for edge 2 (`straight(5..8,i)`) and edge 3 (`straight(9..12,i)`). The coefficients of the triangle plane are stored in `straight(13..16,i)`. The geometrical information is calculated in routine `updatecontpen.f`. The planes bordering the triangles are quasi-orthogonal to the triangle in the sense that they are in-between the truly orthogonal planes and the planes through the triangle edges and orthogonal to the neighboring triangles. To this end the mean normals are stored in field `xmastnor(3,*)` (Figure 179).

Further geometrical information is the area of each slave face `i`, stored in `areaslav(i)`, the area corresponding to slave node `i`, stored in `springarea(1,i)` and the penetration at the start of each step in slave node `i` (< 0 if any penetration, else 0), stored in `springarea(2,i)`. These calculations are performed each time `gencontelem.n2f.f` or `gencontelem.f2f.f` is called.

Subsequently, contact spring elements are generated (routine `gencontelem.f`). To this end, each node belonging to the dependent contact slave surface is treated separately. To determine the master surface the node interacts with, a triangle belonging to the triangulation of the corresponding master surface are identified, such that its center of gravity is closest to the dependent node. Then, a triangle is identified by adjacency, such that the orthogonal projection of the slave node is contained in this triangle. If such a triangle is found, a contact spring element is generated consisting of the dependent node and the independent surface the triangle belongs to, provided the node penetrates the structure or the clearance does not exceed a given margin. Before checking the penetration or clearance an adjustment of the geometry is performed in case the user has activated the `ADJUST` parameter. If any of these conditions is not satisfied, no contact spring element is generated for this dependent node and the next node is treated. The sole purpose of the triangulation of the master surface is the fast identification of the independent face a dependent node interacts with.

The stiffness matrix of the contact spring elements is calculated in `spring-`

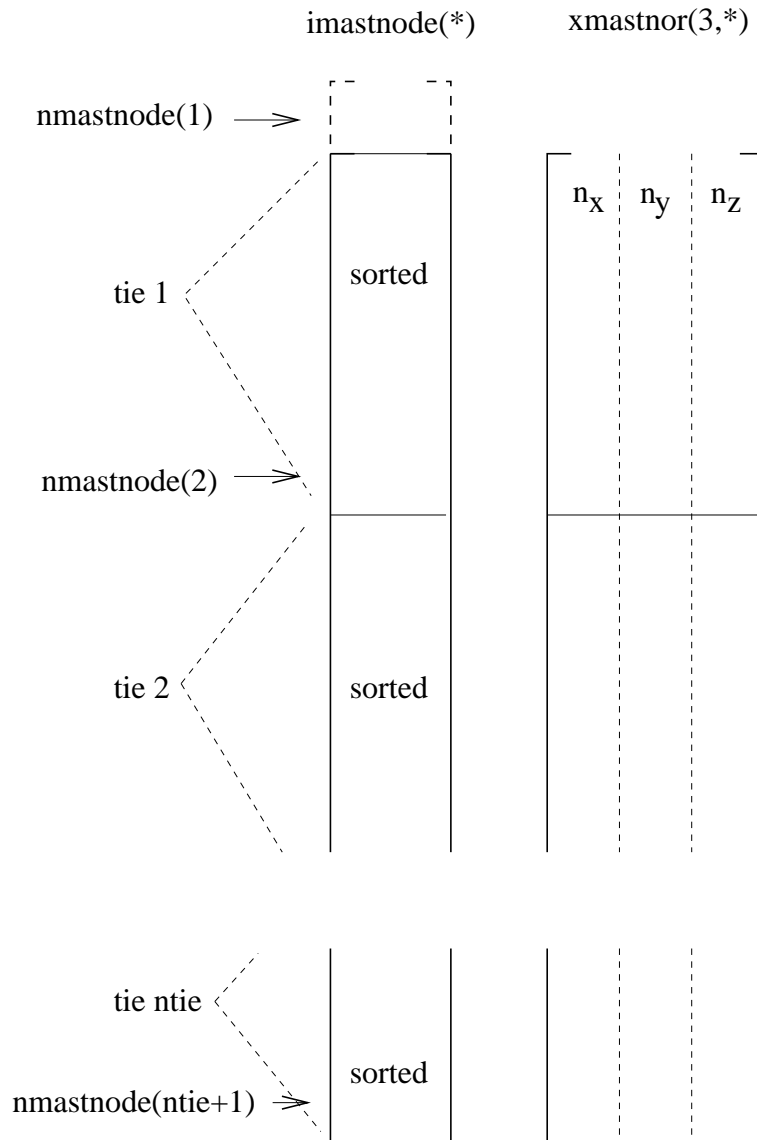

Figure 179: Storage of the master nodes

tiff.f, called by mafillsm.f. In order to determine the stiffness matrix the local coordinates of the projection of the dependent node onto the independent surface are needed. This is performed in attach.f. Use is made of a cascaded regular grid to determine the location within the independent surface which is closest to the dependent node. The local coordinates are needed to determine the shape functions and their derivatives. The contact force is determined in springforc.f, called by results.f. Here too, routine attach.f is called.

Since the geometrical information is recalculated in every iteration, large deformations are taken into account, unless the user has specified SMALL SLIDING in which case the geometry update takes place once at the start of each new increment.

The material properties of the contact spring, defined by means of the *SURFACE INTERACTION, the *SURFACE BEHAVIOR and the *FRICTION card, are stored in the same fields as the *MATERIAL and *ELASTIC,TYPE=ISOTROPIC card.

The general structure of the contact algorithms for nonlinear geometric calculations is as follows. The contact topology is determined in inicont.c. This routine is called once at the start of a new step and calls the following routines:

- allocont: determining the number of master triangles and slave entities (nodes or faces, depending on whether the slave surface is nodal or facial)
- triangucont: triangulation of the master side
- trianeighbor: determining the triangle neighbors in the triangulation of the master side
- findsurface (only for node-to-face contact): catalogueing the external faces and creating the fields ipoface and nodface
- tiefaccont: determining the field islavsurf and itiface (slave nodes), islavnode and nslavnode (slave faces), iponoels, xnoels and inoels (only for node-to-face contact) and imastnode and nmastnode (master nodes).

For face-to-face penalty contact the routine precontact.c is called at the start of each new increment. Its purpose is:

- to calculate the center of gravity and the quasi-orthogonal planes to the master triangles (updatecontpen.f).
- to calculate the clearance (if the *CLEARANCE keyword card is used) and/or adjust the slave nodes (if the ADJUST parameter is used on the *CONTACT PAIR card) at the start of the first step (adjustcontactnodes.f).
- to determine the location of the integration points in the slave faces based on the matching of the slave and the master faces (slavintpoints.f).

contact spring element i (node-to-face penalty)

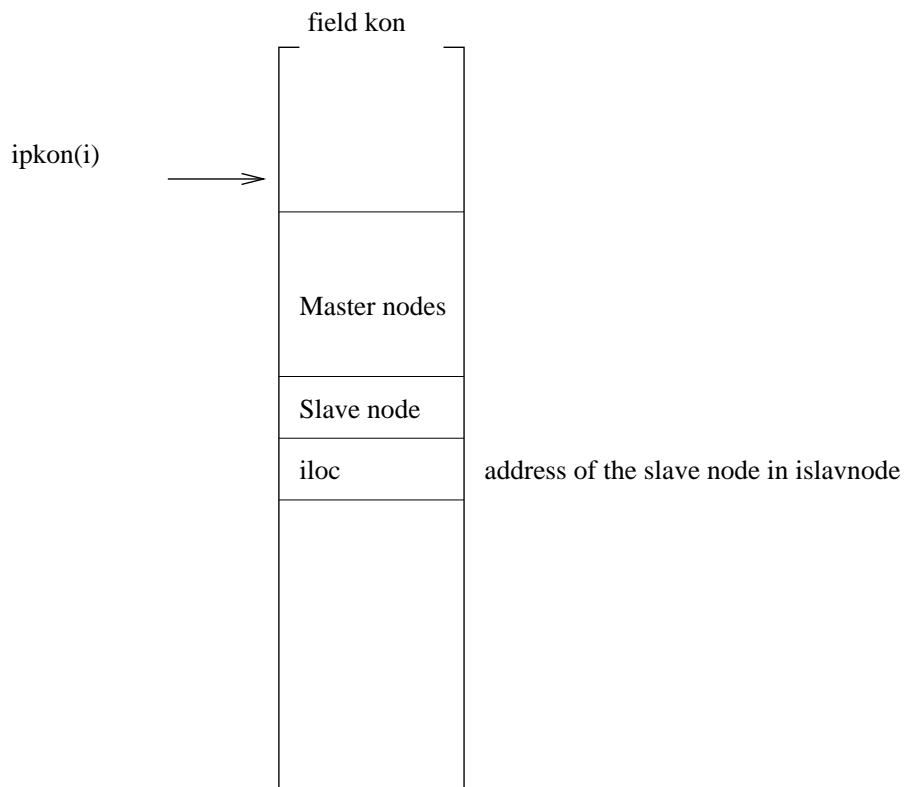

Figure 180: Topology of the node-to-face contact elements

contact spring element i (face-to-face penalty)

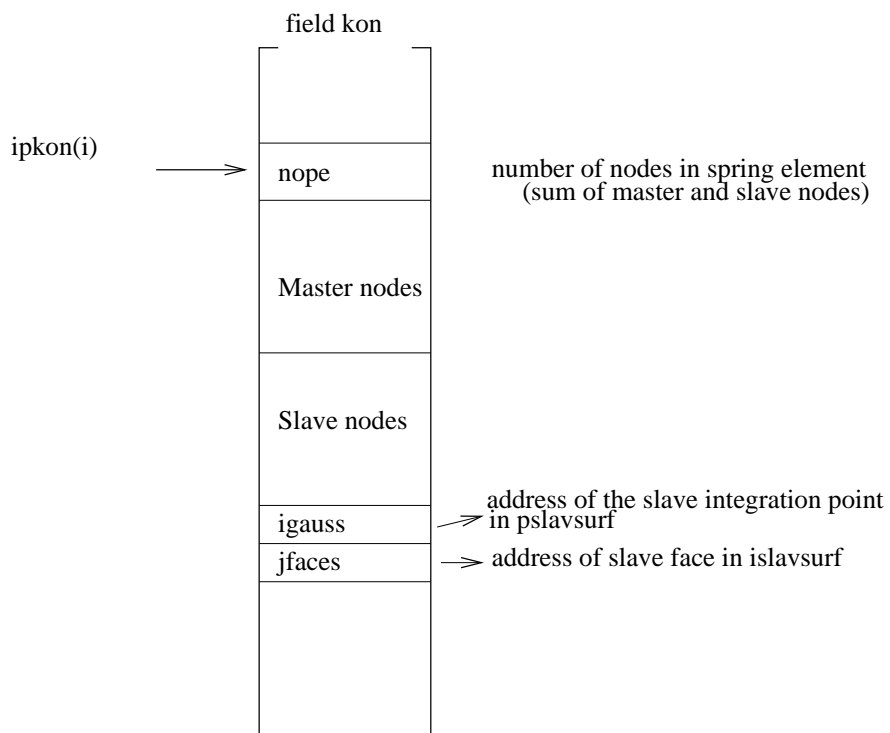

Figure 181: Topology of the face-to-face penalty contact elements

Furthermore, for face-to-face penalty contact the routine `interpolatestate` is called at the start of each new increment. It interpolates the state variables (internal variables such as the slip accumulated so far) from the integration points at the end of the previous increment, if any, to the new integration points determined in `slavintpoints.f`. Indeed, at the start of a new increment the matching between the slave and master surfaces is done anew and usually leads to a change in the location of the integration points.

For contact with friction there are 9 internal variables (state variables). They are:

- 1-3: the slip vector
- 4-6: the relative displacement between slave and master surface
- 7-9: the relative tangential displacement between slave and master surface

All of them are stored in global Cartesian coordinates.

The `contact.c` routine is called once per iteration. This applies to node-to-face as well as face-to-face penalty contact. For node-to-face contact the purpose of `contact.c` is:

- to update the center of gravity and the quasi-orthogonal planes of the master triangles (`updatecontpen.f`).
- to generate contact spring elements at those slave nodes for which the clearance does not exceed a predefined value c_0 (`gencontelem_n2f.f`). Additionally, `gencontelem_2nf` performs the calculation of:
 - the area of all slave faces (stored in `areaslav`).
 - the area corresponding to each slave node and the overlap at the start of the first step (stored in `springarea`).

If a spring element is generated, its topology is stored in field `kon` in accordance to Figure 180. The parameter `igauss` is needed to identify the area and overlap.

For face-to-face penalty contact `contact.c` only calls routine `gencontelem_f2f`. At the start of a new increment the field `pmastsurf` is filled for those slave integration points for which an opposite master face is found. It contains the local coordinates of the master face, its label ($10 \times \text{element} + \text{local face number}$) and the local normals. Furthermore, field `springarea` is filled containing the corresponding slave area and the overlap at the start of each increment in the first step. Please note that `pmastsurf` and `springarea` are calculated at the start of an increment and kept constant for all iterations across the complete increment. The contact spring elements, however, are generated anew in each iteration based on the sign of the clearance. A contact element is generated only if the clearance is negative (i.e. in case of penetration). The topology of the spring element is stored in field `kon` (Figure 181) and contains the total number

Table 20: Storage of contact data in elcon.

entry	kind	exponential	linear	tabular	tied
1	*SURFACE BEHAVIOR	β	σ_∞	-	-
2	*SURFACE BEHAVIOR	p_0	K	-	K
3	*SURFACE BEHAVIOR	1	2	3	4
4	*SURFACE BEHAVIOR	-	c_{0coef}	$c_{0coef} = 10^{-3}$	not used
5	*CONTACT DAMPING	c_d	c_d	c_d	not used
6	*FRICTION	μ	μ	μ	-
7	*FRICTION	λ	λ	λ	λ
8	*CONTACT DAMPING	c_t	c_t	c_t	-
9	*GAP HEAT GENERATION	η	η	η	-
10	*GAP HEAT GENERATION	f	f	f	-
11	*GAP HEAT GENERATION	$\ \mathbf{v}_{rel}\ $	$\ \mathbf{v}_{rel}\ $	$\ \mathbf{v}_{rel}\ $	-

of nodes (slave+master), the master nodes, the slave nodes, the address of the integration point in pslavsurf and the address of the slave face in islavsurf.

Contact properties (*SURFACE BEHAVIOR, *FRICTION, *CONTACT DAMPING, *GAP HEAT GENERATION) are preceded by a *SURFACE INTERACTION card and are internally treated as material properties, i.e. the *SURFACE INTERACTION card is treated in the same way as a *MATERIAL card. All data are stored in the elastic field elcon, except for the tabular pressure-overclosure data, which are stored in the isotropic hardening field plicon, and the gap conductance data, which are stored in the kinematic hardening field plkon. The contact properties in elcon are stored in the order of Table 20 for exponential, linear, tabular and tied pressure-overclosure behavior.

The following remarks are due:

- “entry” is the index inside elcon. For instance, for linear pressure-overclosure behavior $\text{elcon}(2,1,i)=K$, where “1” is the temperature label (no temperature dependence for this constant) and “i” is the internal material number.
- β and p_0 are the constants describing the exponential pressure-overclosure behavior.
- K is the normal spring stiffness; σ_∞ is the tensile stress at infinity for a regularized linear pressure-overclosure behavior (only for node-to-face contact).
- the third line in the table is the number of the method, i.e. exponential pressure-overclosure = 1 etc. These numbers are stored as reals by adding 0.5.

- $c_0 = c_{0coef} \sqrt{\text{slave area}}$, where $c_0 > 0$ is the clearance below which a contact spring element is generated. For tabular pressure-overclosure behavior the value of c_{0coef} is fixed. c_0 is only used in this form for node-to-face contact. For face-to-face contact $c_0 = 0$.
- c_d is the normal damping coefficient, c_t is the tangent damping function.
- η is the fraction of dissipated energy converted into heat, f is the surface distribution factor while $\|\mathbf{v}_{rel}\|$ is the relative velocity between the parts in contact. The latter value is only meant for two-dimensional axisymmetric calculations in which the relative velocity between the stator and rotor is known (rotary machinery). In that case, no friction should be defined.
- tied pressure-overclosure is only available for face-to-face penalty contact

10.4.2 Massless contact

Massless contact is coded uniquely for explicit dynamics. The underlying contact definition uses a node-to-surface approach and fields such as `islavnode` and `imastnode` are common with the penalty contact formulation.

Within a new step some of the fields for massless contact have to be set up only once in the step. Therefore, they are calculated at the beginning of `nonlingeoc` in the section in which the initial acceleration for the α -method is calculated (just after setting up the matrices in `mafillsmmain.c`).

At first the degrees of freedom needed to set up the $[W_b]$ matrix (cf. Section 6.7.8) are collected in `create_contactdofs.f`. These are:

- the slave node degrees of freedom. Each of them is characterized by a node number “node” and a global direction “j”. The value of `nactdof(j,node)` is stored in field `kslav`, the value $10*\text{node}+j$ in `lslav`. Subsequently `kslav` is sorted in ascending order taking `lslav` along. The size of these fields is $3*\text{nslavs}$, since no SPC’s or MPC’s are allowed in the contact area for massless contact.
- the slave and master nodes degrees of freedom. They are stored in a similar way in fields `ktot` and `ltot`. The size of these fields is `neqtot:=3*nslavs+3*nmasts`.

Furthermore, in the same routine the friction coefficient in each slave node is stored in field `fric(1...nslavs)`.

Then, the matrices in between the big brackets in Equation (358) are calculated. They consist of a linear combination of the mass and damping matrix, or, since Rayleigh damping is assumed, a linear combination of the mass and stiffness matrix. Subsequently, these matrices are reduced to the internal degrees of freedom only (recall that $[M_{ii}]$ and $[D_{ii}]$ is used in Equation (358)) in subroutine `reducematrix.f`. Finally, the matrix corresponding to the left hand side is factorized. It will be repeatedly used for solving the system in each increment.

Now, the increment loop can start. The following actions are performed:

- At the beginning of each increment the $[W_b]$ matrix is formed. This is performed in subroutine `gencontelem_n2f.f`. Each set of three columns in the matrix corresponds to the dependence of the degrees of freedom of a slave node in a local coordinate system (splitting the normal direction from the tangential directions) on the degrees of freedom of the nodes of the opposite master face in global coordinates. The matrix is stored using fields `auw`, `jqw`, `iroww` and `nzsw`. Vector `auw` contains the nonzero values column by column, the corresponding row number is stored in `jqw`, in total there are `nzsw` entries. The first entry in each column is stored in `jqw(i)`, $i=1,..3*\text{nslavs}+1$.
- contrary to penalty dynamic calculations, no extrapolation from the previous result is done, i.e. `prediction.c` is skipped.
- contrary to penalty dynamic calculations, the stiffness matrix is assembled in `mafillsmmain.c`.
- contrary to penalty dynamic calculations, no residual is calculated in `cal-residual.c`. Instead, routine `massless.c` is called with the following actions:
 - The rows in $[W_b]$ are rearranged; in `gencontelem_n2f.f` the order is such that first the slave nodes are treated, followed by the master nodes. In routine `expand_auw` the new row order is the one dictated by field `nactdof`.
 - In routine `extract_matrices` $[K_{bb}]$, $[K_{bi}]$, $[K_{ib}]$ and $[K_{ii}]$ are extracted from the global stiffness matrix. Matrix $[K_{bb}]$ is stored using fields `jqbb`, `aubb`, `adbb`, `irowbb` and `icolbb` (the latter contains the number of nonzero entries in each column), because of symmetry only half the matrix is stored. The subdiagonal terms of matrix $[K_{bi}]$ are stored using fields `jqbi`, `aubi`, `irowbi` and `nzsbi`. The subdiagonal terms of matrix $[K_{ib}]$ are stored using fields `jqib`, `auib`, `irowib` and `nzsib`. To obtain matrix $[K_{bi}]$ it has to be complemented by the transpose of the $[K_{ib}]$ matrix. Notice that matrix $[K_{ib}]$ is assumed to have as many rows as $[K]$ and three times `nslavs` columns (any entries not belonging to the contact nodes are set to zero; this does not blow up the storage, since only non-zeros are stored). Mutatis mutandis this also applies to $[K_{bi}]$. Matrix $[K_{ii}]$ is actually not extracted, the entries of matrices $[K_{bi}]$, $[K_{ib}]$ and $[K_{bb}]$ are set to zero (off-diagonal) or one (diagonal).
 - Calculation of $\{F_b(t^k)\} - [K_{bi}]\{U_i\}^k$ in `resforccont.f`. This is the residual force due to external forces and forces from the internal nodes in the absence of contact forces $\{\lambda\}^k$.
 - factorizing $[K_{bb}]$ and premultiplying the residual force with $[K_{bb}]^{-1}$ by solving a linear equation system. The result is stored in field `gapdisp` and is the displacement field at the boundary nodes in global coordinates assuming zero contact force.

- calculating the gap by premultiplying gapdisp by $[W_b]^T$ and adding $\{g_0\}$ in `detectactivecont.f`; determining the active contact degrees of freedom by identifying negative gap values. The number of active degrees of freedom is `nacti`, the corresponding entries in `iacti(j), j=1..3*nslavs` are numbered in ascending order, the nonactive degrees in `iacti` are set to zero.
 - calculate $[G]$ and $\{c\}$ (using `gapdisp`) and storing them in `gmatrix(1..nacti,1..nacti)` and `cvec(1..nacti)`.
 - solving the inclusion problem in `auglag_inclusion.f`. Field `alglob(1..neqtot)` contains $[W_b]\{\lambda\}$, i.e. the contact forces in slave and master nodes in global coordinates, field `al(1..3*nslavs)` contains $\{\lambda\}$, i.e. the contact forces in the slave nodes in a local coordinate system.
 - calculate $\{U_b\}^k$ using Equation (348).
 - calculate the right hand side of Equation (358).
- Solve the equation system corresponding to Equation (358). Since the left hand side is stored in fields `adb` and `aub` this is covered by the regular penalty dynamic calculations and does not require special treatment.
 - Calculate a pseudo velocity in the contact boundary nodes by calculating $(\{U_b\}^k - \{U_b\}^{k-1})/\Delta t$; this is needed for the next step.
 - Use routines `resultsini.c` and `iniparll.c` to calculate $\{U_i\}^{k+1}$ and $\{U_b\}^k$.

10.5 Storing distributions for local coordinate systems

In CalculiX distributions can be used to define local coordinate systems in an elementwise fashion. The corresponding keyword is `*DISTRIBUTION`. Since this option is strongly related to the `*ORIENTATION` keyword, the latter's data structure is used to cover distributions as well.

An orientation `i` is described by its name in `orname(i)`, the coordinates of its defining points `a` and `b` in `orab(1..6,i)` and a flag defining whether the local coordinate system is rectangular (value 1.) or cylindrical (value -1.) in `orab(7,i)`. For each layer `j` of element `k` the entry `ielorien(j,k)` points to the local orientation (default: 0, i.e. no local system).

The `*DISTRIBUTION` cards in an input deck are always treated before any `*ORIENTATION` cards (independent of the order in which the user has set up his input deck; the key routine taking care of this is `keystart.f`). As soon as a `*DISTRIBUTION` card is encountered, as may orientations are created as there are lines underneath the `*DISTRIBUTION` card. For each of these orientations `i` the distribution name (let us call this `distname`) is stored in `orname(i)` and the defining points `a` and `b` in `orab(1..6,i)`. The entry `orab(7,i)` takes the default zero. For each element `k` in which a distribution is defined (first entry in all lines underneath the `*DISTRIBUTION` card except the first one, which defines the default) `ielorien(1,k)` is set to the appropriate orientation `i` containing the correct distribution for this element, preceded by a minus sign, i.e. `ielorien(1,k)=-i`.

The minus sign indicates that this orientation is optional and not yet active. It can only be activated by the correct combination of an *ORIENTATION and *SOLID SECTION card.

As soon as an *ORIENTATION card (e.g. with name ornam) is encountered using this distribution all orientations i are checked on whether their name coincides with the name of the distribution, i.e. whether $orname(i)=distname$. If so:

- the name of the orientation is replaced by ornam, i.e. $orname(i)=ornam$.
- $orab(7,i)$ is set to the kind of local system defined on the *ORIENTATION card
- If an additional rotation angle about a local axis is defined on the *ORIENTATION card, $orab(1..6,i)$ is modified appropriately

Notice that $distname$ and $ornam$ may be identical. The only way in which to detect that $orname(i)$ points to an orientation and not just a distribution is by checking $orab(7,i)$. If this is zero it is a distribution, else it is an orientation.

As soon as a *SOLID SECTION card is encountered pointing to an orientation (e.g. OR) the following steps are undertaken:

- In a loop over all orientations i the first occurrence of the orientation name on the *SOLID SECTION card (i.e. OR) is checked for. This orientation is the default one (if the *ORIENTATION was defined by a distribution it corresponds to the first line underneath a *DISTRIBUTION card).
- For all elements k belonging to the element set on the *SOLID SECTION card: if $m=ielorien(1,k)$ is negative AND $orname(-m)=OR$ AND $orab(7,-m)$ is nonzero then $ielorien(1,k)$ is set to $-m$. Else it is set to the default orientation.

10.6 Determining the matrix structure

This part consists of the following subparts:

- matching the SPC's
- de-cascading the MPC's
- determining the matrix structure

10.6.1 Matching the SPC's

In each step the SPC's can be redefined using the $OP=NEW$ parameter. To assure a smooth transition between the values at the end of the previous step and the newly defined values these must be matched. This matching is performed in subroutine `spcmatch.f`. For each SPC i active in a new step the following cases arise:

- a SPC j in the same node and in the same direction was also active in the previous step; this SPC is identified and the corresponding value, which was stored in position j of field `xbounold` before calling `spcmatch`, is now stored in position i of field `xbounold`.
- in the previous step no corresponding SPC (i.e. in the same direction in the same node) was applied. The appropriate displacement value at the end of the previous step is stored in position i of field `xbounold`.

10.6.2 De-cascading the MPC's

Multiple point constraints can depend on each other. For instance:

$$5.u_1(10) + 8.u_1(23) + 2.3u_2(12) = 0 \quad (911)$$

$$u_1(23) - 3.u_1(2) + 4.u_1(90) = 0 \quad (912)$$

The first equation depends on the second, since $u_1(23)$ belongs to the independent terms of the first equation, but it is the dependent term in the second (the first term in a MPC is the dependent term and is removed from the global system, the other terms are independent terms). Since the dependent terms are removed, it is necessary to expand (“de-cascade”, since the equations are “cascaded” like falls) the first equation by substituting the second in the first, yielding:

$$5.u_1(10) + 24.u_1(2) - 32.u_1(90) + 2.3u_2(12) = 0 \quad (913)$$

This is done in subroutine `cascade.c` at least if the MPC's which depend on each other are linear. Then, the corresponding terms are expanded and the MPC's are replaced by their expanded form, if applicable.

However, the expansion is not done if any of the MPC's which depend on each other is nonlinear. For nonlinear MPC's the coefficients of the MPC are not really known at the stage in which `cascade.c` is called. Indeed, in most cases the coefficients depend on the solution, which is not known yet: an iterative procedure results. Therefore, in a nonlinear MPC terms can vanish during the solution procedure (zero coefficients) thereby changing the dependencies between the MPC's. Thus, the dependencies must be determined in each iteration anew and subroutine `cascade.c` is called from within the iterative procedure in subroutine `nonlgeo.c`. This will be discussed later.

In `cascade.c` there are two procedures to de-cascade the MPC's. The first one (which is the only one productive right now) is heuristic and iteratively expands the MPC's until no dependencies are left. This procedure worked very well thus far, but lacks a theoretical convergence proof. The second procedure, which is assured to work, is based on linear equation solving and uses SPOOLES. The dependent terms are collected on the left hand side, the independent ones on the right hand side and the sets of equations resulting from setting one independent term to 1 and the others to 0 are subsequently solved: the system of equations

$$[A] \{U_d\} = [B] \{U_i\} \quad (914)$$

is solved to yield

$$\{U_d\} = [A]^{-1} [B] \{U_i\} \quad (915)$$

in which $[U_d]$ are the dependent terms and $[U_i]$ the independent terms. However, in practice the MPC's do not heavily depend on each other, and the SPOOLES procedure has proven to be much slower than the heuristic procedure.

10.6.3 Determining the matrix structure.

This important task is performed in `mastruct.c` for structures not exhibiting cyclic symmetry and `mastructcs.c` for cyclic symmetric structures. Let us focus on `matruct.c`.

The active degrees of freedom are stored in a two-dimensional field `nactdof`. It has as many rows as there are nodes in the model and four columns since each node has one temperature degree of freedom and three translational degrees. Because the 1-d and 2-d elements are expanded into 3-d elements in routine "gen3delem.f" there is no need for rotational degrees of freedom. In C this field is mapped into a one-dimensional field starting with the degrees of freedom of node 1, then those of node 2, and so on. At first, all entries in `nactdof` are deactivated (set to zero). Then they are (de)activated according to the following algorithm:

- In a mechanical or a thermomechanical analysis the translational degrees of freedom of all nodes belonging to elements are activated.
- In a thermal or a thermomechanical analysis the temperature degree of freedom of all nodes belonging to elements are activated.
- All degrees of freedom belonging to MPC's are activated (dependent and independent)
- The degrees of freedom corresponding to SPC's are deactivated by setting them to $-2*i$ (i.e. a negative number) where i is the number of the SPC.
- The degrees of freedom corresponding to the dependent side of MPC's are deactivated by setting them to $-(2*i-1)$ (i.e. a negative number) where i is the number of the MPC.

Then, the active degrees of freedom are numbered (positive numbers). Subsequently, the structure of the matrix is determined on basis of the topology of the elements and the multiple point constraints.

For SPOOLES, ARPACK and the iterative methods the storage scheme is limited to the nonzero SUBdiagonal positions of the matrix only. The scheme is as it is because of historical reasons, and I do not think there is any reason not to use another scheme, such as a SUPERdiagonal storage. The storage is described as follows:

- the field `irow` contains the row numbers of the SUBdiagonal nonzero's, column per column.
- `icol(i)` contains the number of SUBdiagonal nonzero's in column `i`.
- `jq(i)` contains the location in field `irow` of the first SUBdiagonal nonzero in column `i`

All three fields are one-dimensional, the size of `irow` corresponds with the number of nonzero SUBdiagonal entries in the matrix, the size of `icol` and `jq` is the number of active degrees of freedom. The diagonal entries of the matrix stored separately and consequently no storage information for these items is needed.

The thermal entries, if any, are stored after the mechanical entries, if any. The number of mechanical entries is `neq[0]` (C-notation), the total number of entries (mechanical and thermal) is `neq[1]`. In the same way the number of nonzero mechanical SUBdiagonal entries is `nzs[0]`, the total number of SUBdiagonal entries is `nzs[1]`. In thermomechanical applications the mechanical and thermal sub-matrices are assumed to be distinct, i.e. there is no connection in the stiffness matrix between the mechanical and the thermal degrees of freedom. Therefore, the mechanical and thermal degrees of freedom occupy two distinct areas in the storage field `irow`.

File `mastructcs` calculates the storage for cyclic symmetric structures. These are characterized by the double amount of degrees of freedom, since cyclic symmetry results in a complex system which is reduced to a real system twice the size. The cyclic symmetry equations are linear equations with complex coefficients and require a separate treatment. The fields used for the storage, however, are the same.

10.7 Filling and solving the set of equations, storing the results

In this section a distinction is made between the types of analysis and the solver used:

- for linear static calculations with SPOOLES or the iterative solver the appropriate routine is `prespooles.c`
- for nonlinear static or dynamic calculations (which implies the use of SPOOLES or the iterative solver) routine `nonlingeo.c` is called. This includes all thermal calculations.
- for frequency analysis without cyclic symmetry routine `arpack.c` is called.
- for a frequency analysis with cyclic symmetry conditions the appropriate routine is `arpackcs.c`
- for a buckling analysis `arpackbu.c` is called

- for linear dynamic calculations (i.e. modal dynamic analysis) the routine is `dyna.c`
- finally, for steady state dynamics calculations the routine is `steadystate.c`

10.7.1 Linear static analysis

For a linear static analysis (`prespooles.c`) the structure is as follows:

- determine the loads at the end of the step in routine `tempload.f`
- fill the matrix (routine `mafillsm`)
- solve the system of equations (routines `spooles` or `preiter`)
- determine the required results for all degrees of freedom, starting from the displacement solution for the active degrees of freedom. This is done in subroutine `results.f`, including any storage in the `.dat` file.
- store the results in the `.frd` file. For structures not exhibiting cyclic symmetry this is performed in routine `out.f`, for cyclic symmetric structures routine `frdcyc.c` is called before calling `out`. If an error occurred during the matrix fill the output is reduced to the pure geometry.

The different routines in the above listing will be discussed separately, since they are common to most types of analysis.

10.7.2 Nonlinear calculations

For nonlinear calculations the solution is found by iteration. Because a step is possibly too large to obtain convergence, the option exists to subdivide the step into a finite number of increments. The size of the initial increment in a step is defined by the user (line beneath `*STATIC`, `*DYNAMIC`, `*VISCO`, `*HEAT TRANSFER` or `*COUPLED TEMPERATURE-DISPLACEMENTS`) and also the number of increments can be controlled by the user (parameter `DIRECT`). However, in most cases it is advisable to let the program determine the size of the increments, based on the convergence rate of the previous increments. The solution in each increment is obtained by iteration until the residual forces are small enough.

Therefore, the structure of `nonlingeo` corresponds to the flow diagram in Figure 182. It lists all subroutines, each line is a subroutine. On the upper right “preliminary” is an abbreviation for five subroutines which recur often. If a subroutine or a group of subroutines is enclosed by square brackets, it means that it is only run under certain conditions. In detail, the structure of `nonlingeo` looks like:

- before the first increment
 - determine the number of advective degrees of freedom and the number of radiation degrees of freedom (`envtemp.f`)

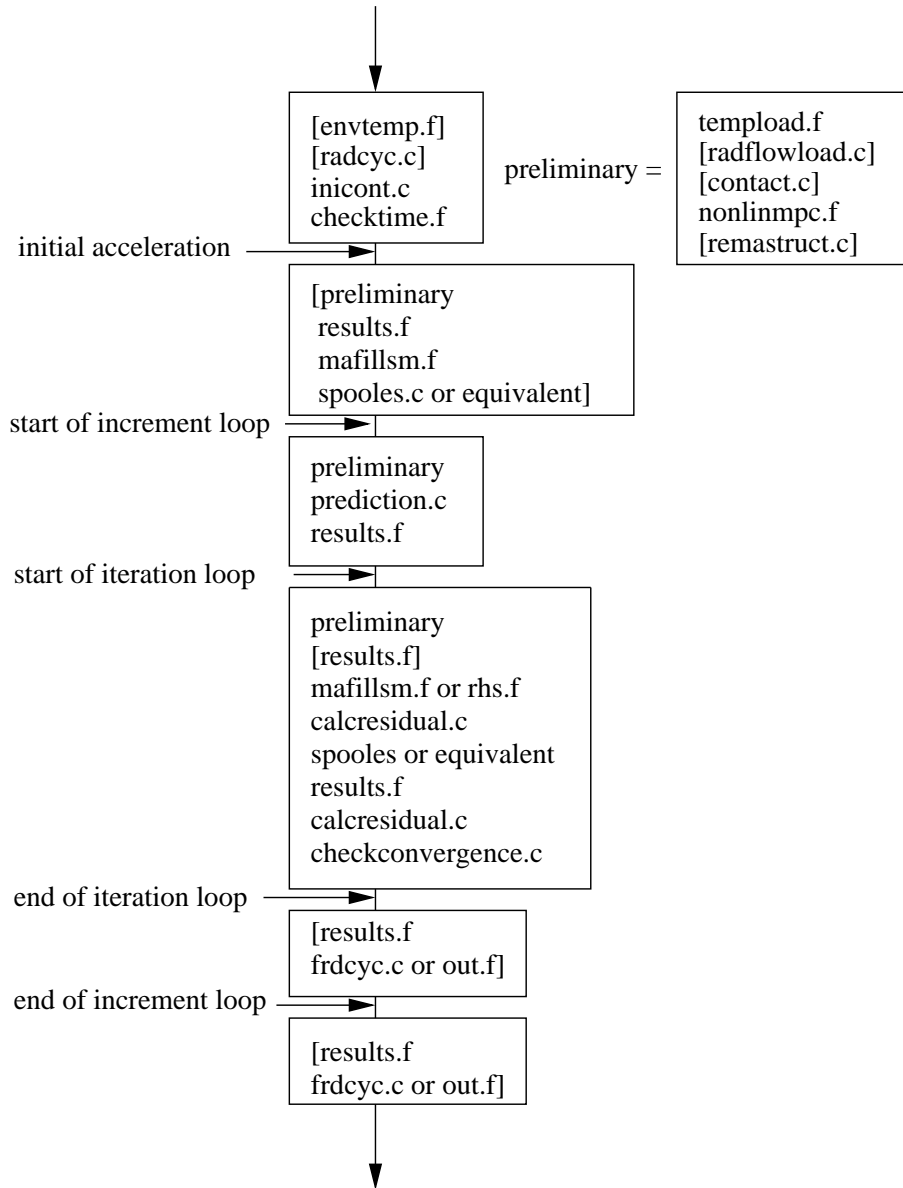
Figure 182: Flow diagram for subroutine `nonlinge0`

- expanding the radiation degrees of freedom in case of cyclic symmetry (radcyc.c)
- initialization of contact fields and triangulation of the independent contact surfaces (inicont.c)
- take into account time point amplitudes, if any (checktime.f).
- calculate the initial acceleration and the mass matrix (specific heat matrix for transient heat transfer calculations) for dynamic calculations. (initialaccel.c). This includes:
 - * determine the load at the start of the increment (tempload.f)
 - * for thermal analyses: determine the sink temperature for forced convection and cavity radiation boundary conditions (radflowload.f)
 - * update the location of contact and redefine the nonlinear contact spring elements (contact.f)
 - * update the coefficients of nonlinear MPC's, if any.
 - * if the topology of the MPC's changed (dependence of nonlinear MPC's on other linear or nonlinear ones) or contact is involved: call remastruct
 - * determine the internal forces (results.f).
 - * construction of the stiffness and mass matrix and determination of the external forces (mafillsm.f); This is also done for explicit calculations in order to get the mass matrix.
 - * subtract the internal from the external forces to obtain the residual forces;
 - * solving the system of equations with in spooles.c, preiter.c or any other available sparse matrix solver. For explicit dynamic calculations explicit calculation of the solution (no system needs to be solved). The solution is the acceleration at the start of the step.
- for each increment
 - before the first iteration
 - * determine the load at the end of the increment (tempload.f)
 - * for thermal analyses: determine the sink temperature for forced convection and cavity radiation boundary conditions (radflowload.f)
 - * update the location of contact and redefine the nonlinear contact spring elements (contact.f)
 - * update the coefficients of nonlinear MPC's, if any.
 - * if the topology of the MPC's changed (dependence of nonlinear MPC's on other linear or nonlinear ones) or contact is involved: call remastruct.
 - * prediction of the kinematic vectors

- * determination of the internal forces (results.f). The difference between the internal and the external forces are the residual forces. If the residual forces are small enough, the solution is found. If they are not, iteration goes on until convergence is reached. The residual forces are the driving forces for the next iteration.
- in each iteration
 - * determine the load at the end of the increment (tempload.f)
 - * for thermal analyses: determine the sink temperature for forced convection and cavity radiation boundary conditions (radflowload.f)
 - * update the location of contact and redefine the nonlinear contact spring elements (contact.f)
 - * update the coefficients of nonlinear MPC's, if any.
 - * if the topology of the MPC's changed (dependence of nonlinear MPC's on other linear or nonlinear ones) or contact is involved: call remastruct and redetermine the internal forces (results.f).
 - * construct the system of equations and determination of the external forces (mafillsm.f); for explicit dynamic calculations no system has to be set up, only the external forces are determined (rhs.f).
 - * subtract the internal from the external forces to obtain the residual forces (calcredidual.c);
 - * solving the system of equations with in spooles.c, preiter.c or any other available sparse matrix solver. For explicit dynamic calculations explicit calculation of the solution (no system needs to be solved).
 - * calculating the internal forces and material stiffness matrix in each integration point in results.f
 - * deriving the new residual by subtracting the updated internal forces from the external forces (calcredidual.c).
 - * If the residual is small enough iteration ends (checkconvergence.c). The convergence criteria are closely related to those used in ABAQUS.
- after the final iteration, if output was not suppressed by user input control:
 - * determining the required results for all degrees of freedom, starting from the displacement solution for the active degrees of freedom. This is done in subroutine results.f, including any storage in the .dat file.
 - * storing the results in the .frd file. For structures not exhibiting cyclic symmetry this is performed in routine out.f, for cyclic symmetric structures routine frdcyc.c is called before calling out. If an error occurred during the matrix fill the output is reduced to the pure geometry.

- after the final increment (only if no output resulted in this final increment due to user input control)
 - determining the required results for all degrees of freedom, starting from the displacement solution for the active degrees of freedom. This is done in subroutine results.f, including any storage in the .dat file.
 - storing the results in the .frd file. For structures not exhibiting cyclic symmetry this is performed in routine out.f, for cyclic symmetric structures routine frdcyc.c is called before calling out. If an error occurred during the matrix fill the output is reduced to the pure geometry.

10.7.3 Frequency calculations

Frequency calculations are performed in subroutines arpack.c for structures not exhibiting cyclic symmetry and arpackcs.c for cyclic symmetric structures. Frequency calculations involve the following steps:

- filling the stiffness and mass matrix in mafillsm.f. The stiffness matrix depends on the perturbation parameter: if iperturb=1 the stress stiffness and large deformation stiffness of the most recent static step is taken into account ([23])
- solving the eigenvalue system using SPOOLES and ARPACK
- calculating the field variables in results.f, including storing in the .dat file
- storing the results in .frd format in out.f

The eigenvalues and eigenmodes are solved in shift-invert mode. This corresponds to Mode 3 in ARPACK ([48]). Suppose we want to solve the system

$$[K] \{U\} = \omega^2 [M] \{U\} \quad (916)$$

then the shift-invert mode requires algorithms for solving

$$[K - \sigma M] \{U\} = \{X_1\} \quad (917)$$

and for calculating

$$\{Y\} = [M] \{X_2\} \quad (918)$$

where $\{X_1\}$ and $\{X_2\}$ are given and σ is a parameter. In CalculiX, it is set to 1. These operations are used in an iterative procedure in order to determine the eigenvalues and the eigenmodes. For the first operation SPOOLES is used. SPOOLES solves a system by using a LU decomposition. This decomposition is performed before the iteration loop initiated by ARPACK since the left hand side of Equation (917) is always the same. Only the backwards substitution is

inside the loop. The second operation (Equation (918)) is performed in routine `op.f` and is a simple matrix multiplication. Notice that this routine depends on the storage scheme of the matrix.

For cyclic symmetric structures the following additional tasks must be performed:

- Expanding the structure in case more than one segment is selected for output purposes (parameter `NGRAPH` on the `*CYCLIC SYMMETRY MODEL` keyword card). This is done before the `mafillsm` call.
- Calculating the results for the extra sectors based on the results for the basis sector. This is performed after the call of routine `results.f`.

10.7.4 Buckling calculations

To calculate buckling loads routine `arpackbu.c` is called. The following steps are needed in a buckling calculation:

- calculation of the stresses due to the buckling load. This implies setting up the equation system in `mafillsm.f`, solving the system with `SPOOLES` and determining the stresses in `results.f`
- setting up the buckling eigenvalue system consisting of the stiffness matrix $[K]$ of the previous static step (including large deformation stiffness and stress stiffness) and the stress stiffness matrix $[KG]$ of the buckling load [23].
- loop with starting value for $\sigma = 1$
 - LU decomposition of $[K - \sigma KG]$
 - iterative calculation of the buckling factor with `ARPACK`
 - determination of the buckling mode
 - if $5\sigma < \text{buckling factor} < 50000\sigma$ exit loop, else set $\sigma = \text{buckling factor}/500$ and cycle
- determine the stresses and any other derived fields

The buckling mode in `ARPACK` (Mode 4, cf [48]) is used to solve a system of the form

$$[K] \{U\} = \lambda [KG] \{U\} \quad (919)$$

where $[K]$ is symmetric and positive definite and $[KG]$ is symmetric but indefinite. The iterative procedure to find the eigenvalues requires routines to solve

$$[K - \sigma KG] \{U\} = \{X_1\} \quad (920)$$

and to calculate

$$\{Y\} = [K] \{X_2\}. \quad (921)$$

Similar to the frequency calculations, the LU decomposition (SPOOLES) to solve Equation (920) is performed before the loop determining the buckling factor, since the left hand side of the equation does not vary. The matrix multiplication in Equation (921) is taken care of by routine `op.f`.

A major difference with the frequency calculations is that an additional iteration loop is necessary to guarantee that the value of the buckling factor is right. Indeed, experience has shown that the value of σ matters here and that the inequality $5\sigma < \text{buckling factor} < 50000\sigma$ should be satisfied. If it is not, the whole procedure starting with the LU decomposition is repeated with a new value of $\sigma = \text{buckling factor}/500$. If necessary, up to four such iterations are allowed.

10.7.5 Modal dynamic calculations

For modal dynamic calculations the response of the system is assumed to be a linear combination of the lowest eigenmodes. To this end, the eigenvalues and eigenmodes must have been calculated, either in the same run, or in a previous run. At the end of a frequency calculation this data, including the stiffness and mass matrix, is stored in binary form in a `.eig` file, provided the `STORAGE=YES` option is activated on the `*FREQUENCY` or `*HEAT TRANSFER,FREQUENCY` card. This file is read at the beginning of file `dyna.c`.

In file `dyna.c` the response is calculated in an explicit way, for details the reader is referred to [23]. Modal damping is allowed in the form of Rayleigh damping. Within file `dyna` the following routines are used:

- `tempload`, to calculate the instantaneous loading
- `rhs`, to determine the external force vector of the system
- `results`, to calculate all displacements, stresses and/or any other variables selected by the user

Notice that if nonzero boundary conditions are prescribed (base loading, e.g for earthquake calculations) the stiffness matrix of the system is used to calculate the steady state response to these nonzero conditions. It serves as particular solution in the modal dynamic solution procedure.

10.7.6 Steady state dynamics calculations

For steady state dynamics calculations the steady state response of the system to a harmonic excitation is again assumed to be a linear combination of the lowest eigenmodes. To this end, the eigenvalues and eigenmodes must have been calculated, either in the same run, or in a previous run. At the end of a frequency calculation this data, including the stiffness and mass matrix, is

stored in binary form in a .eig file, provided the STORAGE=YES option is activated on the *FREQUENCY or *HEAT TRANSFER,FREQUENCY card. This file is read at the beginning of file steadystate.c.

In file steadystate.c the response is calculated in an explicit way, for details the reader is referred to [23]. Modal damping is allowed in the form of Rayleigh damping. Within file steadystate the following routines are used:

- tempload, to calculate the instantaneous loading
- rhs, to determine the external force vector of the system
- results, to calculate all displacements, stresses and/or any other variables selected by the user

Notice that if nonzero boundary conditions are prescribed (base loading, e.g for earthquake calculations) the stiffness matrix of the system is used to calculate the steady state response to these nonzero conditions. It serves as particular solution in the modal dynamic solution procedure.

10.8 Major routines

10.8.1 mafflsm

In this routine the different matrices are constructed. What has to be set up is summarized in the logicals mass, stiffness, buckling, rhsi and stiffonly. For instance, if the mass matrix must be calculated, mass=true, else mass=false. Notice that mass and stiffonly are defined as vectors of length 2. The first entry applies to mechanical calculations, the second entry to thermal calculations. If mass(1)=true the mass matrix for mechanical calculations or the mechanical part of coupled temperature-displacement calculations is determined and similarly, if mass(2)=true the specific heat matrix for thermal calculations or the thermal part of coupled temperature-displacement calculations is determined. This distinction is necessary to account for differences between mechanical and thermal calculations. It suffices to calculate the mass matrix in mechanical calculations only once, whereas the outspoken dependence of the specific heat on temperature requires the calculation of the specific heat matrix in each iteration. In what follows the mechanical stiffness matrix and thermal conductivity matrix will be simply called the stiffness matrix, the mechanical mass matrix and thermal heat capacity matrix will be called the mass matrix.

The routine consists of two major loops over all elements. The first loop constructs the mechanical part of the matrices, if applicable, the second loop constructs the thermal part, if applicable. Each loop runs over all elements, thereby collecting the element stiffness matrix and/or mass matrix from routine e_c3d and e_c3d_th for mechanical and thermal calculations, respectively, and inserting them into the global stiffness matrix and/or mass matrix, taking into account any linear multiple point constraints. The right-hand side matrices are also constructed from the element right-hand sides and any point loading.

To compose the element stiffness matrices the material stiffness matrices ($d\boldsymbol{\sigma}/d\boldsymbol{\epsilon}$) in the integration points of the elements are needed. These are recovered from storage from the last call to subroutine `results.f`. For the mass matrices the density and/or specific heat in the integration points is needed. These quantities are obtained by interpolation in the appropriate temperature range. No other material data need to be interpolated.

10.8.2 results

In subroutine `results.f` the dependent quantities in the finite element calculation, such as the displacements, stress, the internal forces, the temperatures and the heat flux, are determined from the independent quantities, i.e. the solution vector of the equation system. There are several modes in which `results.f` can be called, depending on the value of the variable `iout`:

- `iout=-1`: the displacements and temperatures are assumed to be known and used to calculate strains, stresses..., no result output
- `iout=0`: the displacements and temperatures are calculated from the system solution and subsequently used to calculate strains, stresses..., no result output
- `iout=1`: the displacements and temperatures are calculated from the system solution and subsequently used to calculate strains, stresses..., result output is requested (`.dat` or `.frd` file)
- `iout=2`: the displacements and temperatures are assumed to be known and used to calculate strains, stresses..., result output is requested (`.dat` or `.frd` file)

Calculating the displacements and/or temperatures from the result vector only involves the use of the relationship between the location in the solution vector and the physical degrees of freedom in the nodes (`field nactdof`), together with SPC and MPC information.

To obtain derived quantities such as stresses and heat flux a loop over all element integration points is performed. This is first done for mechanical quantities, then for heat transfer quantities.

In the mechanical loop the strain is determined from the displacements. For linear geometric calculations this is the infinitesimal strain, else it is the Lagrangian strain tensor [23]. For certain materials (e.g. the user defined materials) the deformation gradient is also determined. Then, `materialdata.me.f` is called, where the material data are obtained for the integration point and actual temperature (such as Young's modulus, thermal strain etc.). A subsequent call to `mechmodel.f` determines the local material gradient ($d\boldsymbol{\sigma}/d\boldsymbol{\epsilon}$) and the stress. From this the internal forces can be calculated.

The heat transfer loop is very similar: after calculation of the thermal gradient, the material data are interpolated in `materialdata.th.f`, the heat flux and

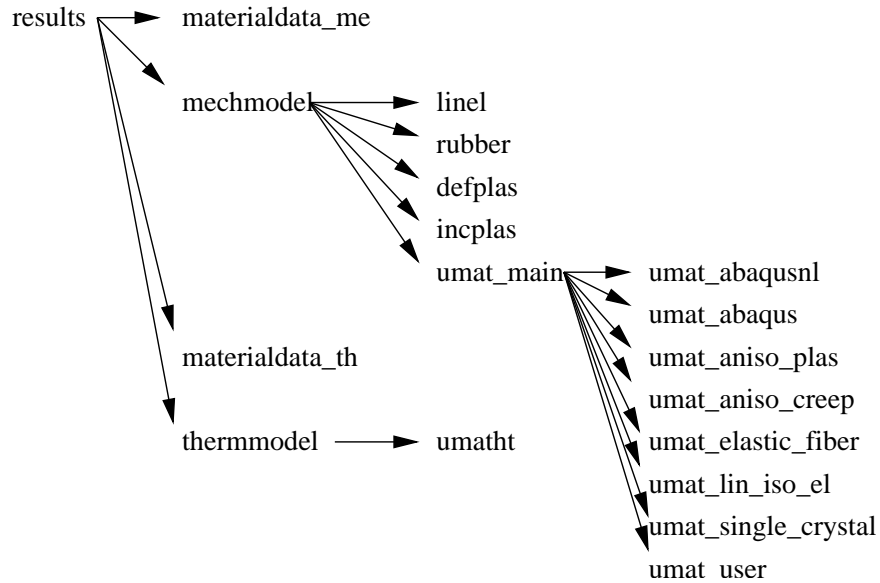

Figure 183: Flow diagram for subroutine results

tangent conductivity matrix ($d\mathbf{q}/d\Delta\theta$) are determined in `thermmodel.f` and the concentrated internal heat vector is calculated.

The tangent material matrices determined in `mechmodel.f` and `thermmodel.f` are stored for further use in the construction of the element stiffness matrices (cf. `mafillsm.f`). An overview of the subroutine structure to calculate the stress and tangent material matrices and any related quantities is shown in Figure 183.

Notice that the stresses and heat flux determined so far was calculated in the integration points. In the last part of `results.f` these values are extrapolated to the nodes, if requested by the user.

10.9 Aerodynamic and hydraulic networks

Aerodynamic and hydraulic networks are solved separately from the structural equation system. This is because networks generally lead to small sets of equations (at most a couple of thousand equations) which are inherently asymmetric. If solved together with the structural system, the small network contribution would lead to a complete asymmetric matrix and increase the computational time significantly. Moreover, especially aerodynamic networks are very nonlinear and require more iterations than structural nonlinearities. Consequently, the small network contribution would also lead to a lot more iterations. Therefore, the matrices of networks are set up and solved on their own taking the structural solution from the previous structural iteration as boundary condition. In a similar way, the network solution acts as boundary condition for the

Table 21: Variables in fluid nodes.

DOF	corner node	midside node
0	total temperature	-
1	-	mass flow
2	total pressure	-
3	static temperature	geometry

next structural iteration.

10.9.1 The variables and the equations

In Sections 6.9.16 and 6.9.17 the governing equations for aerodynamic and hydraulic networks were derived. It was shown that the basic variables for aerodynamic networks are the total temperature, the total pressure and the mass flow (in addition, one geometric parameter may be defined per element as additional unknown. This option has to be coded in the program in order to be active. Right now, this option only exists for the gate valve). For hydraulic networks (transporting a liquid instead of a gas) these reduce to the temperature, pressure and mass flow (for whatever follows the terms total temperature and total pressure apply to gases and can be replaced by temperature and pressure for fluids). All other variables can be calculated based on these three quantities. This is actually not a unique choice but seems to be best suited for our purposes. This is completely different from the structural unknowns, which are taken to be the temperature and the displacements. Therefore, the degrees of freedom 0 to 3 which are used for structural calculations are redefined for networks according to Table 21.

A distinction is being made between corner nodes and midside nodes of fluid elements. Remember that network elements consist of two corner nodes and one middle node (Section 6.2.37). The mass flow is not necessarily uniquely determined at the corner nodes, since more than two branches can come together. Therefore, it is logical to define the mass flow as unknown in the middle of a network element. The same applies to the geometric parameter, if applicable. Similarly, the total temperature or total pressure may not be known within the element, since the exact location of discontinuities (such as enlargements or orifices) is not necessarily known. Consequently, it is advantageous to define the total temperature and total pressure as unknowns in the corner nodes. The static temperature is not a basic variable. Once the total temperature, mass flow and total pressure are known, the static temperature can be calculated. It is a derived quantity and only useful for gases.

Similar to field nactdof for structural applications a field nactdog is introduced for network applications. It can be viewed as a matrix with 4 rows and as many columns as there are nodes in the model (including structural nodes; this is done to avoid additional pointing work between the local gas node number

Table 22: Degrees of freedom in fluid nodes (field nactdog).

DOF	corner node	midside node
0	total temperature	-
1	-	mass flow
2	total pressure	-
3	-	geometry

Table 23: Conservation equations in fluid nodes (field nacteq).

DOF	corner node	midside node
0	energy	-
1	mass	-
2	-	momentum
3	if > 0: independent node of isothermal element the node belongs to;	-

and the global node number). It indicates whether a specific degree of freedom in a gas node is active: if the entry is nonzero (actually positive; contrary to nactdog nactdog does not take negative values) it is active, else it is inactive (which means that the value is known or not applicable because the node is a structural node). The degrees of freedom correspond to the first three rows of Table 21 and are repeated in Table 22 for clarity. Here too, only the first three rows are relevant.

Consequently, if nactdog(2,328) is nonzero, it means that the total pressure in node 328 is an unknown in the system. Actually, the nonzero value represents the number of the degree of freedom attached to the total pressure in node 328. The number of the degree of freedom corresponds with the column number in the resulting set of equations. What nactdog is for the degrees of freedom is nacteq for the equations. It is a field of the same size of nactdog but now a nonzero entry indicates that a specific conservation equation applies to the node, cf. Table 23.

If nacteq(1,8002) is nonzero, it means that the conservation of mass equation has to be formulated for node 8002. The nonzero value is actually the row number of this equation in the set of equations. If the value is zero, the equation does not apply, e.g. because the mass flow in all adjacent elements is known. The last row in field nacteq (at least for corner nodes) is used to account for isothermal conditions. These only apply to gas pipes of type GAS PIPE ISOTHERMAL and exit restrictors preceded by an isothermal gas pipe element. An isothermal element introduces an extra equation specifying that the static temperature in the two corner nodes of the pipe is equal. This can be transformed into a nonlinear equation in which the total temperature in one

node (the dependent node) is written as a function of the total temperature in the other node and the other variables (total pressure in the nodes, mass flow). To account for this extra equation, the conservation of energy is not expressed for the dependent node (indeed, one can argue that, in order for the static temperatures to be equal an unknown amount of heat has to be introduced in the dependent node). So if $nacteq(3,8002)=n$ is nonzero it means that node 8002 is the dependent node in an isothermal relation linking the static nodal temperature to the one of node n .

Field $ineighe(i), i=1, \dots, ntg$ is used to determine the static temperature in an end node. If it is zero, node i is a mid-node. If it is equal to -1, the node is a chamber, for which the static temperature equals the total temperature. If it is positive, its value is the element number of a gas pipe element or restrictor element (but not equal to a restrictor wall orifice), for which the static temperature is different from the total temperature. The mass flow of the referred element is used to calculate the static temperature from the total temperature.

10.9.2 Determining the basic characteristics of the network

In subroutine `envtemp.f` the basic properties of the network are determined. It is called at the start of `nonlingeo.c`. At first the gas nodes are identified and sorted. A node is a gas node if any of the following conditions is satisfied:

- it is used as environment node of a forced convection `*FILM` boundary condition. The temperature in such a node is an unknown. This also implies that a midside node of a network element cannot be used as environment node in a `*FILM` condition.
- it is used as environment node of a forced convection `*DLOAD` boundary condition. The total pressure in such a node is unknown (the static pressure may be more applicable for gas networks, this has not been implemented yet).
- it belongs to a network element. If it is an corner node the total temperature and the total pressure are unknowns, if it is a midside node the mass flow is unknown and the geometry may be unknown too.

In that way also the field `nactdog` is filled (with the value 1 for an unknown variable, 0 else). Next, the nodes with known boundary values (`*BOUNDARY` cards) are removed (the corresponding value in `nactdog` is set to zero), and the unknown DOFs are numbered consecutively yielding the final form for `nactdog`. Notice that the global number of gas node i is `itg(i)`. Since field `itg` is ordered in an ascending order, subroutine `nident.f` can be used to find the local gas node number for a given global number. In the remaining text “gas node i ” refers to the local number whereas “node i ” refers to a global number.

In a loop over all network elements the necessary equations are determined. In a given corner node the conservation of mass equation is formulated if the mass flow in at least one of the adjacent network elements is unknown. The conservation of energy is written if the temperature in the corner node is unknown.

Finally, conservation of momentum equation (also called element equation) is formulated for a midside node of a network element if not all quantities in the element equation are known. This latter check is performed in the subroutine flux.f (for iflag=0). It contains on its own subroutines for several fluid section types, e.g. subroutine orifice.f for the fluid section of type ORIFICE. The number of unknowns relevant for the network element depends on its section type. After having identified all necessary equations in field nacteq they are numbered and the number of equations is compared with the number of unknowns. They must be equal in order to have a unique solution.

Next, multiple point constraints among network nodes are taken into account. They are defined using the *EQUATION keyword card. It is not allowed to use network nodes and non-network nodes in one and the same equation.

Finally, dependent and independent nodes are determined for each isothermal element and the appropriate entries in field nacteq (third row, cf. previous section) are defined. If at the stage of the matrix filling an corner node is a dependent node of an isothermal element the conservation of energy equation in that node is replaced by an equation that the static temperature in the dependent and independent node are equal.

10.9.3 Initializing the unknowns

Solving the structural system and the network is done in an alternating way. At the start of a network loop the unknowns (mass flow, total temperature, total pressure) are initialized. This is especially important for gas networks, since the initial values are taken as starting solution. Since the gas equations are very nonlinear, a good initial guess may accelerate the Newton-Raphson convergence quite a bit (or make a convergence possible in the first place).

At first an initial pressure distribution is determined. To that end the pressure value for nodes with a pressure boundary condition is stored in $v(2,i)$, where i is the global node number. If no pressure boundary conditions applies, minus the number of elements to which the node belongs is stored in the same field. If a node belongs to only one element, it is a boundary node and a fictitious initial pressure slightly smaller than the minimum pressure boundary condition is assigned to it. In that way, all boundary nodes are guaranteed to have a value assigned. The initial pressure in all other nodes is determined by solving for the Laplace equation in the network, i.e. the value in a node is the mean of the values in all surrounding nodes. To obtain a more realistic distribution the values are biased by an inverse tangent function, i.e. the values upstream decrease more slowly than on the downstream side of the network.

Another item taken care of at the start of initialnet.f is the determination of the number of gas pipe or restrictor elements the nodes belong to. If an end node i belongs to at most 2 elements of type gas pipe or restrictor and to no other elements one of the global element numbers is stored in $ineighe(i)$ and the static temperature is determined from the other variables using the mass flow in this element. If not, the node is considered to be a big chamber for which total and static values coincide.

The temperature initial conditions are fixed at 293 K (only for those nodes for which no temperature boundary condition applies). In general, the temperature initial conditions are not so critical for the global convergence. For geometric quantities the initial value is zero. For the gate valve this is changed to the minimum allowable value of 0.125 (cf. liquidpipe.f).

Based on the total temperature and total pressure the mass flow in the elements is determined using the element equations. This is the second task to be accomplished by the element routines (for iflag=1).

Finally, the static temperature is calculated for the nodes not identified as chambers based on the total pressure, total temperature and mass flow.

10.9.4 Calculating the residual and setting up the equation system

The residual of the governing equations is calculated in subroutine resultnet.f. At the start of the routine the static temperature is calculated for the nodes not identified as chambers based on the total pressure, total temperature and mass flow. Then, a loop is initialized covering all network elements. For each element the contributions to the conservation of mass equation and to the conservation of energy equation (or, equivalently, to the isothermal equation if the element is an isothermal gas pipe element) of its corner nodes are determined. Subsequently, the satisfaction of the element equation is verified. This is the third mode the element routines are called in, characterized by iflag=2. Finally, the energy contributions resulting from the interaction with the walls and due to prescribed heat generation in the network are taken into account. The residual constitutes the right hand side of the network system.

Setting up the equation system is done in subroutine maffillnet.f. The structure of the routine is very similar to the resultnet routine: in a loop over all elements the coefficients of the equations (conservation of mass and momentum and the conservation of energy, or, if applicable, the isothermal condition) are determined. This includes effects from the interaction with the walls. This leads to the left hand side of the system of equations.

10.9.5 Convergence criteria

Convergence is checked for the total temperature, mass flow, total pressure and geometry separately. The convergence check is done in checkconvnet.c.

10.10 Turbulent Flow in Open Channels

Although the turbulent flow in open channels is also modeled using 3-node network elements, the solution procedure is quite different. This is because the flow direction is usually known and hydraulic jumps (Froude number equal to 1; this is the equivalent of sonic conditions in aerodynamic flow) can occur within an element, also when the cross section is constant. This makes the approach of setting up a nonlinear system of equations which is to be solved by repeatedly linearizing the system very difficult. The usual approach to the steady state

Table 24: Degrees of freedom in open channel nodes.

DOF	corner node	midside node
0	temperature	-
1	-	mass flow
2	depth	-
3	critical depth	-

equations of turbulent flow in open channels is as follows (focussing at first on one channel consisting of one line of elements):

- Determine the upstream element of the channel (usually a sluice gate or weir)
- Assume supercritical flow, i.e. the flow is controlled by upstream conditions
- Proceeding from upstream to downstream, calculate the fluid depth.
- If for some reason supercritical flow is not feasible (e.g. the critical depth is reached somewhere along the channel), proceed downstream to the next element and so on until there is again a supercritical solution, e.g. starting at node A. Before going on with this supercritical solution start from node A upstream calculating a subcritical flow until a jump occurs or the upstream element in the channel is reached. Then, continue downstream calculating a supercritical flow starting at node A.
- if the downstream element in the channel is reached (usually a reservoir) check for a fall or jump in the reservoir. Else start a subcritical calculation starting at the entry of the reservoir (raccordation) and proceed upstream until a jump is detected or the upstream element is reached.

Starting this iterative procedure at the upstream element is logical, since it usually allows for the determination of the mass flow (a reservoir doesn't) and if there is some section in which the flow is supercritical it is governed by the upstream conditions. The unknowns are the temperature, the fluid depth (measured in the direction of the gravity vector; the specification of the gravity vector with the *DLOAD card is mandatory for channel calculations) and the mass flow. They correspond with the degrees of freedom shown in Table 24. The critical depth is actually not an independent unknown, it is calculated as soon as the mass flow is known.

Right now, the fluid element routines are the sluicgate (includes the weir), the straightchannel, the reservoir and the contraction (includes the enlargement and the step) routines. The IO elements (input/output) do not need a routine and are not considered to be "true" elements. Field `ineighe(i)` gives the number of true elements in end node `i`. Fields `iponoel` and `inoel` allow for the determination of ALL elements (true and IO) belonging to node `i`. Entry `iponoel(i)`

points to a first element in `inoel(1,iponoel(i))`, `inoel(2,iponoel(i))` points to the next element etc. up to the point where `inoel(2,...)=0`. The upstream, middle and downstream node of an element `nelem` are called `nup`, `nmid` and `ndo`, respectively, the upstream and downstream neighbor (assuming there is only one) `nelup` and `neldo`. The upstream and downstream depth is `hup` and `hdo`.

There are extra routines for the calculation of:

- the critical depth `hk` (“kritische hoogte” in Dutch) (`hcrit.f`)
- the normal depth `he` (“hoogte van eenparige beweging” in Dutch) (`hnorm.f`)
- the depth `h2` after a jump corresponding to the depth `h1` before (`hns.f`; “hoogte na sprong” in Dutch)

The friction can be of type White-Coolebrook (`xks > 0`) or Manning (Manning coefficient = $-xks$, `xks < 0`). For White-Coolebrook the friction coefficient f is calculated from the grain size `xks` in `friction_coefficient.f`.

The mode of calculation (from upstream to downstream, i.e. supercritical, or from downstream to upstream, i.e. subcritical) is denoted by the variable `mode` (character*1) taking 'F' for forward or 'B' for backward, respectively. If the forward mode (frontwater curve) is temporarily interrupted to calculate a backwater curve the switching point (point A above) is stored on a stack: the number of stored switching points is `nstack`, for switching point `i` the element upstream of A is stored in `istack(1,i)`, and the node corresponding to A in `istack(2,i)`.

The above iterative procedure leads to the following algorithm:

- Look for a sluice gate or wear element one of the end nodes of which is connected to only one “true” element (i.e. the element itself). This is the starting point of a frontwater curve calculation
- Proceed downstream calculating a supercritical flow. Determine the next downstream element using the actual element and its downstream node (`nelup` and `nup` for the downstream element) and fields `iponoel` and `inoel`.
- If no supercritical flow is possible, set `hup = -1` and move downstream until supercritical flow is feasible again, e.g. at node A. Store the appropriate information of this switching node in fields `nstack` and `istack`. Important here is that a negative depth points to the unfeasibility of a frontwater curve starting at that node.
- proceed from node A upstream with subcritical flow. For each element use its number and its upstream node to determine the next upstream element. Continue this until a jump is detected or the originating sluice gate or weir is reached. Then, proceed downstream with the most recently stored information on stack
- when arriving at a reservoir, check for a fall or jump in the reservoir. Else start an upstream calculation as detailed before.

Now, some more detailed information on the true elements is given.

10.10.1 Sluice Gate

Remember that a sluice gate can be used upstream of a channel, or somewhere in between a channel.

For a frontwater curve:

- if $h_{up}=0$, the discharge Q must be given (the discharge Q will be used here interchangeably for the mass flow \dot{m} ; the ratio is the constant density ρ). For the gate height (h_a) one can determine h_{up} .
- else if $h_{up} > 0$ and $Q=0$, the discharge can be calculated from h_{up} and h_a .
- else either $h_{up} > 0$ and consequently $Q \neq 0$ or $h_{up} < 0$. In the latter case the sluice gate must be somewhere in the middle of the channel and Q will be known. So Q is known at any rate and h_{up} is determined based on Q and h_a .

For a backwater curve:

- if h_{up} is a boundary condition Q^* can be calculated based on h_{up} , h_{do} and h_a (h_{do} is known since the curve is a backwater curve). If this value matches the value Q used for the backwater curve the solution is found. Else, restart the backwater curve calculation with $(Q+Q^*)/2$ until convergence.
- else the discharge was given at the sluice gate. From Q , h_a and h_{do} the value of h_{up} can be determined.

10.10.2 Wear

A wear can only be used upstream of a channel. It corresponds to a sluice gate with an infinite value for h_a .

For a frontwater curve:

- if $h_{up}=0$, the discharge Q must be given. The value of h_{do} corresponds to the critical depth for Q . From this h_{up} can be determined.
- else if $h_{up} > 0$ and $Q=0$, the discharge can be calculated from h_{up} and the knowledge that critical conditions are reached at h_{do} .

For a backwater curve:

- if h_{up} is a boundary condition Q^* can be calculated based on h_{up} and h_{do} (h_{do} is known since the curve is a backwater curve). If this value matches the value Q used for the backwater curve the solution is found. Else, restart the backwater curve calculation with $(Q+Q^*)/2$ until convergence.
- else the discharge was given at the sluice gate. From Q and h_{do} the value of h_{up} can be determined.

10.10.3 Straight Channel

For mode='F', the possibility of a frontwater curve is examined. This is feasible in all conditions except for $h_{up} \geq h_k < h_e$ (mild slope). For the calculation of the frontwater curve the equation of Bresse is integrated using a trapezoid rule. To that end the interval of h_{up} to the target height is divided into (ndata-1) intervals with length Δh . For a mild slope the target height is h_k (i.e. the frontwater curve approaches h_k for increasing values of the channel length coordinate s ; this corresponds to a A3 curve), for a strong slope it is h_e ; this corresponds to a B2 or B3 curve). Right now, ndata is set to 100 in radflowload.c. Knowing the value h_i and s_i , h_{i+1} is obtained from $h_{i+1} = h_i + \Delta h$. Then the equation of Bresse is evaluated to obtain $dh/ds(s_i)$ and $dh/ds(s_{i+1})$ from which a fictitious $dh/ds^* = [dh/ds(s_i) + dh/ds(s_{i+1})]/2$ is determined. Then $s_{i+1} = s_i + \Delta h / (dh/ds^*)$. For a strong slope the end of the straight channel element will be reached for $i < \text{ndata}$. Then, the height at the end of the element is obtained by interpolation. For a mild slope this may also occur. Alternatively, for a mild slope h_k may be reached before the end of the channel element. In that case the height in h_{up} is set to -1 and at least part of the element will be governed by a backwater curve. The intermediate points of the integration are stored in fields $sfr(1..\text{ndata},j)$ and $hfr(1..\text{ndata},j)$ for element j , $1 \leq j \leq \text{nflow}$. So j is the relative element number in field ieg . The $jumpup(j)$ indicates the number of actual integration points, $0 \leq jumpup(j) \leq \text{ndata}$. A value of 0 indicates that the curve in this channel element is a complete backwater curve.

For mode='B' the backwater curve starts at ndo . A backwater curve is feasible in all conditions except for $h_{do} \leq h_k > h_e$ (strong slope). The approach is similar to the calculation of a frontwater curve. The target height is now h_k for a strong slope (B1 curve) and h_e for a mild slope (A1 or A2 curve). The values of s and h are now stored in fields $sba(1..\text{ndata},j)$ and $hba(1..\text{ndata},j)$. Notice that the integration now starts at ndo and moves in upstream direction, the integration point numbers, however, are increasing in downstream direction. Consequently integration starts at integration point $ndata$. The value $jumpdo(j)$ indicates the lowest number of the actual integration points, $1 \leq jumpdo(j) \leq \text{ndata}+1$. A value of $ndata+1$ indicates that the curve in the channel element is a complete frontwater curve. For mode='B' it is constantly checked whether a jump occurs. To this end the routine $hns.f$ is used. In case a jump occurs, the value $jumpup(j)$ corresponds the last integration point in fields sfr and hfr for the frontwater curve upstream of the jump and $jumpdo(j)$ corresponds to the first integration point in fields sba and hba for the backwater curve downstream of the jump.

10.10.4 Reservoir

This element is treated in subroutine $reservoir.f$. In forward mode the value of h_{up} can be negative or positive. If it is negative no frontwater curve was calculated and a backwater curve has to be determined (h_{do} is set to -1). If it is positive a backwater curve was calculated and h_{do} is calculated as the height

after a jump using subroutine `hns.f`.

The further calculation depends on the value of `hdo`:

- If `hdo` exceeds the depth of the reservoir `hr` the backwater curve leads to a fall in the reservoir or a jump in the reservoir and the downstream depth is set to `hr`.
- If `hdo` is less than or equal to `hr` the critical `hk` and normal depth `he` are calculated. If $hk < he$ a backwater curve is calculated starting at `hk` in `ndo` (`nstack` is incremented and `istack(1,nstack)` is set to `nelem` and `istack(2,istack)` is set to `ndo`). If $hk \geq he$ a backwater curve is not plausible and no solution is found.

10.10.5 Contraction, Enlargement, Step and Fall

The contraction, enlargement, step and fall are all treated in subroutine `contraction.c`. For these type of elements the width 'b' and the angle ' θ ' may differ upstream and downstream, they are labeled `bup`, `bdo`, `thetaup` and `thetado`. The length of the element can be given explicitly by the user, or if it is zero it is calculated from the coordinates of `nup` and `ndo`. This length is used to calculate a contraction or expansion angle α . Based on this angle a head loss coefficient is calculated and the earth acceleration g is appropriately corrected. For the theory behind this the reader is referred to Section 6.6.5.

For a frontwater curve the specific energy is calculated in `nup`. Then, using subroutine `henergy.f` a supercritical depth is calculated corresponding to the same specific energy and discharge for the downstream geometry of the element (cf. Section 6.6.5) and defined as `hdo`. Two cases arise:

- If `hdo` is positive the solution is found.
- If `hdo` is negative it means that the specific energy downstream has to be increased such that it corresponds to the specific energy corresponding to `hk` for the given discharge. The values of `nelem` and `ndo` are stored to `stack` and a backwater curve is calculated starting at `ndo`.

For a backwater curve the specific energy is calculated in `ndo`. Then, using subroutine `henergy.f` a subcritical depth is calculated corresponding to the same specific energy and discharge for the upstream geometry of the element

- If `hup` is positive the solution is found.
- If `hup` is negative it means that the specific energy upstream has to be increased such that it corresponds to the specific energy corresponding to `hk` for the given discharge. The values of `nelem` and `ndo` are stored to `stack` and the backwater curve calculation is continued at `nup`.

10.11 Three-Dimensional Navier-Stokes Calculations

The major routine for three-dimensional Navier-Stokes Calculations (compressible and incompressible fluids) is `compfluidfem.c`. The flow diagram for incompressible and compressible fluids is shown in Figure 184 and 185, respectively. Right now, `compfluidfem.c` is called once in routine `nonlinge.c`. Later on, combined fluid-structure calculations are planned.

The theory behind the fluid calculations is explained in Section 6.9.19. Incompressible fluids (liquids) are calculated using a semi-implicit scheme (the variables compressible and explicit take the value 0), for compressible fluids (gases) an explicit scheme is used ($\theta_2 = 0$, the variables compressible and explicit take the value 1).

Depending on the application different systems of equations have to be solved, corresponding to the transport equations of mass, momentum, total internal energy, turbulent kinetic energy k and turbulence frequency ω . According to the Characteristic Based Split Method (CBS) [110], a complete increment in time consists of the following steps :

1. First part of the momentum equation: determination of the first time change of the momentum $\Delta(\rho\mathbf{v}^*)$
2. Conservation of mass: determination of the pressure time change Δp for incompressible fluids and the density time change $\Delta\rho$ for compressible fluids
3. Second part of the momentum equation: determination of the second time change of the momentum $\Delta(\rho\mathbf{v}^{**})$
4. Conservation of energy: determination of the time change of the total internal energy per unit of volume $\Delta(\rho\epsilon_t)$
5. Turbulence equations: calculation of the time change of the total kinetic energy $\Delta(\rho k)$ and the turbulence frequency $\Delta(\rho\omega)$

The total time change of the momentum is $\Delta(\rho\mathbf{v}) = \Delta(\rho\mathbf{v}^*) + \Delta(\rho\mathbf{v}^{**})$. Notice that all variables are written in their conservative form. Indeed, it is not \mathbf{v} which is conserved, but $\rho\mathbf{v}$ and so on.

Each of the above sets leads to a linear equation system to be solved for that increment.

10.11.1 Renumbering

In CFD-calculations computational speed is very important. In order to avoid having to check whether nodes and/or elements are really part of the fluid (e.g. because there are gaps in the numbering, or part of the nodes belongs to the structure in fluid-structure calculations), the fluid nodes and fluid elements are renumbered in ascending order without any gaps. This is done in subroutine `rearrangedcf.f`. This also includes the renumbering of the boundary conditions

(SPC's and MPC's) and the loading. In the CBS method the size of the equation system for the conservation laws is the number of nodes, except for the pressure equation for incompressible fluids, in which the SPC boundary condition degrees of freedom are subtracted.

10.11.2 Topological information

Although the major calculations take place in `compfluidfem.c` there is one routine placed at the start of `nonlingeo.c` to collect topological information, which is not changed due to the deformation of the structural components (in fluid-structure interaction calculations). This information includes:

- Storage of all external faces of the mesh (i.e. faces which belong to only one element) in fields `nelemface` (element number) and `sideface` (face number). The field `nelemface` is sorted in ascending order. The face number corresponds to the load face numbering in Section 6.11.2.
- Storage of all solid surface nodes in field `isolidsurf` in ascending order. A solid surface node is a node for which all velocity components are prescribed to be zero. Solid surface nodes belong to external faces of the mesh. The in-stream neighbor of a solid surface node is stored in field `neighsolidsurf`, the distance between both is stored in field `xsolidsurf`. The distance is a geometrical entity and is determined in routine `initialcfdem.f`.
- Storing all freestream nodes in field `ifreestream` in ascending order. A freestream node is a node belonging to an external face which is not a solid surface node and which does not belong to a cyclic MPC.
- Determining the fluid elements to which a given node belongs and storing them in field `iponoel` and `inoel`. For a given node `i` one fluid element to which it belongs is stored in `inoel(1,iponoel(i))`. `inoel(3,iponoel(i))` is a pointer into field `inoel` pointing to another fluid element to which the node belongs. This is continued until `inoel(3,inoel(3,inoel(3,....inoel(3,iponoel(i))))))` is zero.

10.11.3 Determining the structure of the system matrices

In `mastructf.c` the structure of the matrices of the linear equation systems is determined. Indeed, the structure is usually sparse and therefore it is important to know which elements are nonzero. Only these elements are stored. This is the equivalent routine to `mastruct.c` for solid mechanics applications. However, contrary to solid mechanics the single point constraints and multiple point constraints are not taken into account while calculating the structure of the matrix, i.e. boundary conditions do not reduce the system of equations. So the equations are built and solved in the assumption that no SPC's or MPC's are applied. They are taken into account at a later stage of the calculation.

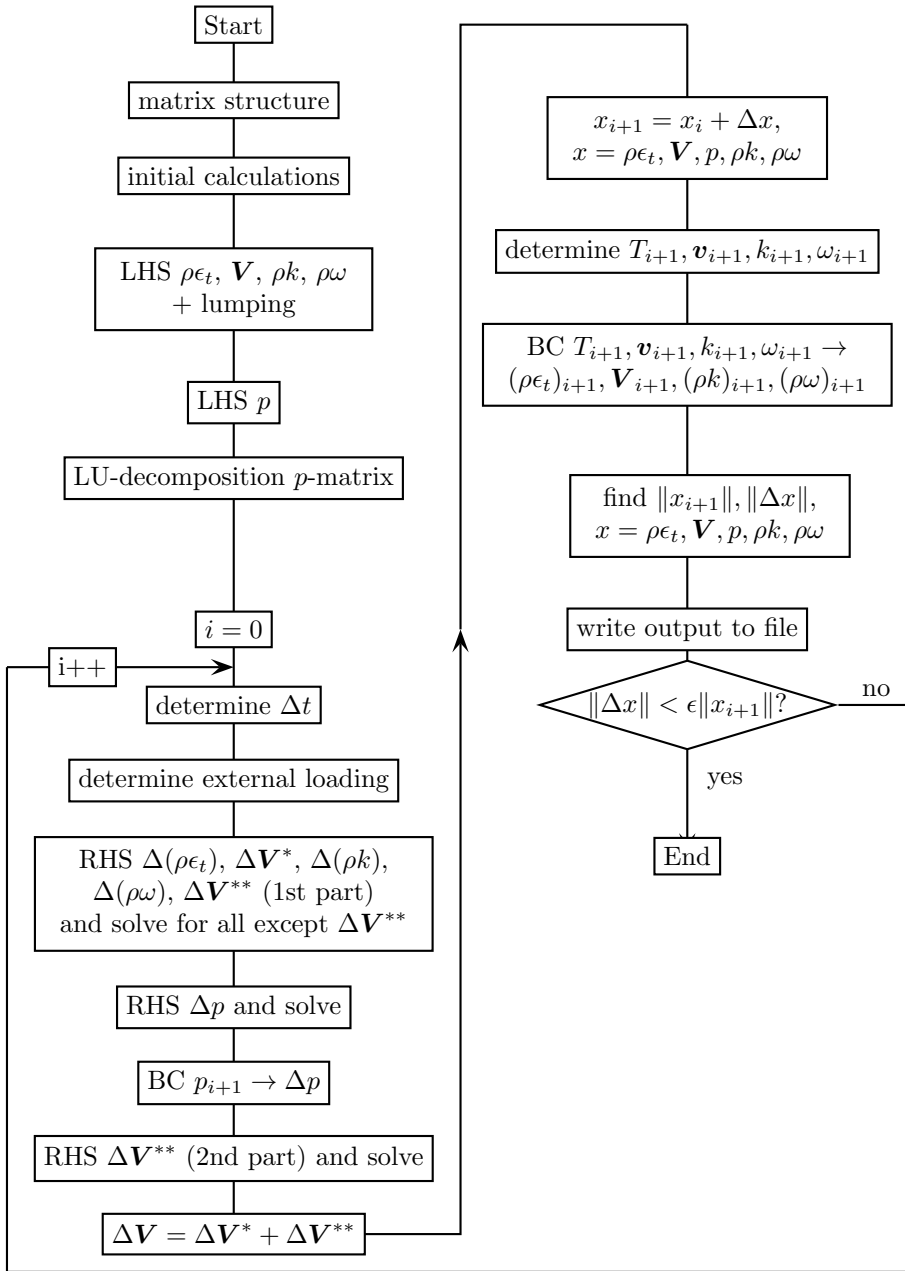

Figure 184: Flow diagram for liquids

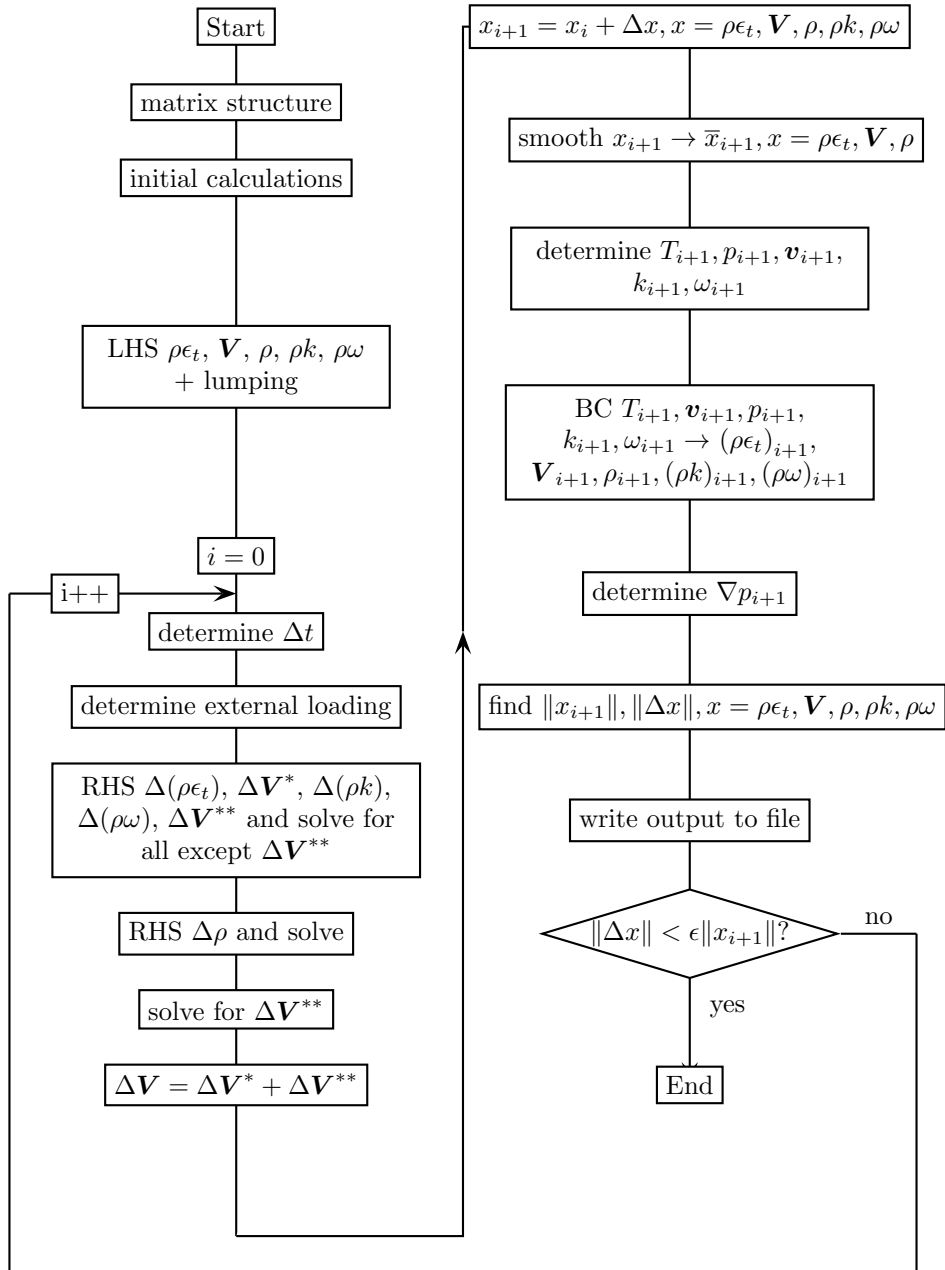

Figure 185: Flow diagram for compressible fluids

This, however, does not apply to the matrix of the pressure equations for incompressible fluids. In the latter equations the SPC's are taken into account, but not the MPC's. The reason for this is that the pressure equation system is the only system for which a regular linear equation solver such as SPOOLES is used. All other systems are diagonalized (lumped). In the absence of SPC's the solution to the pressure equations is not unique and the corresponding matrix is singular. This cannot be handled by a standard solver.

10.11.4 Initial calculations

In subroutine `initialcfdem.f` the following fields are calculated:

- For each node i in the fluid, the distance from this node to the nearest solid surface node. This distance is stored in field `yy(i)` and the corresponding nearest surface node in `jy(i)`. They are needed for the turbulence model.
- For each solid surface node, the distance to the nearest in-flow node. It is stored in field `xsolidsurf`. This quantity is also needed for the turbulence model.
- For each node i the adjacent element height `dh(i)`. This is the minimum of the height of all elements to which the node belongs. The height of an element j is its volume divided by the largest facial area times a factor (e.g. 1 for a hexahedral element and 3 tetrahedral element). This height is stored in field `dhel(j)` and is used to determine `dh(i)`. From `dh(i)` the local time increment Δt_i is calculated.
- For shallow water calculations: the depth in all fluid nodes (this is the element length in the direction of the gravity vector).
- Initial conditions for the turbulence parameters k and ω .
- The value of the conservative variables in all fluid nodes starting from the physical variables. The conservative variables, stored in field `vcon(1..nk,0..mi(2))`, are $\epsilon_t, \rho v_i (i = 1, 2, 3), \rho, \rho k$ and $\rho \omega$. For efficiency first ϵ_t is stored for all nodes, then ρv_1 and so on..., since they are solved for separately (so a single pointer suffices to switch between the fields). The physical variables are the static temperature T , the velocity components v_i , the static pressure p and the turbulence parameters k and ω . They are stored in field `vold(0..mi(2),1..nk)` in the way conventional to structural calculations, i.e. first all parameters for node 1, then for node 2....

The fields calculated in `initialcfdem` frequently contain distances between nodes, which may have changed since the last call to `compfluid`.

10.11.5 The left hand sides of the equation systems

Subsequently the left hand side for the energy system, the momentum system, the pressure system and the turbulence system are calculated in subroutine

mafillvlhs.f (all equation systems except pressure for incompressible fluids; notice that this is one and the same left hand side matrix for all these equations systems) and mafillplhs.f (pressure system for incompressible fluids). For compressible fluids all systems are lumped in subroutine lump.f. The lumped matrix is diagonal. However, the lumped matrix is not stored as such. Indeed, out of efficiency considerations the diagonal of the original matrix, stored in field *adb*, is replaced by itself minus the lumping matrix. The inverse of the lumping matrix is stored in *adl*. For incompressible fluids all equation systems except the pressure equations are lumped. For these pressure equations a LU decomposition is performed for later use in the solution phase of all systems of equations.

For compressible fluids the equation system is reformatted into a row-by-row format in subroutine *convert2rowbyrow* for use in the smoothing procedure.

At this point the preparation phase is finished and the major loop starts calculating the solution at the subsequent time points

10.11.6 Determining the time increment

The first action within the major loop is the determination of the time increment in subroutine *compdt*. The formulas for doing so are Formulas (701) and (703) for liquids and gases, respectively. Notice that the solution influences the time increment, so the increment has to be recalculated at the start of the major loop. For steady state calculations the time step is only recalculated in iterations 2^n , $n \in \mathbb{N}$, since the change in solution decreases the closer steady state. This accelerates the steady state calculations.

10.11.7 Determining the loading

Next is the calculation of the loading. This includes the nodal forces, the facial and volumetric distributed loads, the given velocities, the given static pressure and the given static temperature. These quantities are applied as step values (no ramping), unless an amplitude is defined to change their values.

10.11.8 Step 1: determining ΔV^*

In this step the first correction to the momentum is determined. To this end the Right Hand Side (RHS) of the equation system is calculated (this is done in *mafillvlrhs.f* and *e_c3d_vlrhs.f*). Notice that at this point the RHS is calculated not only the ΔV^* equation system, but also for Δp (partially), ΔV^{**} (partially), $\Delta \epsilon_t$, Δk and $\Delta \omega$ (incompressible fluids) and for $\Delta \rho$ (partially), ΔV^{**} , $\Delta \epsilon_t$, Δk and $\Delta \omega$ (compressible fluids). This saves time since any auxiliary variables have to be calculated only once. Furthermore, this part is parallelized (multithreading) since it involves a loop over all elements which can be nicely cut into pieces. The equations are solved in routine *solveeq* in an iterative way (not only for ΔV^* but also for $\Delta \epsilon_t$, Δk and $\Delta \omega$, which are used later on in the algorithm). This is necessary, since the LHS has been approximated by lumping. The number of iterations is set in *solveeq.f* and is called *maxit*. Right now, it has the value

1, which means that no iterations take place. If the user wishes to change this, the source code has to be recompiled. The solution of the equations is stored in field $v(1..nk,1), v(1..nk,2)$ and $v(1..nk,3)$). Notice that $\Delta \mathbf{V}^*$ is not added to \mathbf{V} at this point. Next, $\Delta \mathbf{V}^*$ is changed such that the velocity boundary conditions are matched. These conditions are applied in the form $\rho_i \mathbf{V}_{i+1}$, where ρ_i is the density at the start of the increment and \mathbf{V}_{i+1} is the velocity boundary condition corresponding to the time at the end of the increment (ρ_{i+1} is not known at this point).

10.11.9 Step 2: determining the pressure/density correction

In the second step the pressure is determined for liquids and the density for gases. For liquids this involves the solution of a regular system of equations, the LHS of which has been LU-decomposed. This can be performed in a parallel way if the user has activated the multithreading option for the linear equation solver, e.g. the option `-DUSE_MT` for SPOOLES in the Makefile and specified the number of cpus by means of the environment variable `NUM_CPU_SOLVE`. The RHS is obtained by adding a term based on $\Delta \mathbf{V}^*$ to the value calculated in `mafillsmv1rhs.f`. This is done in `mafillprhs.f` and `e_c3d_prhs.f`. For gases a lumped system is solved leading to the density correction. In both cases the corrections are stored on a nodal basis in field $v(1..nk,4)$). Finally, for fluids the pressure boundary conditions are applied in routine `applybounp.f`. For gases this has to wait till later, since the gas pressure is not known at this point.

10.11.10 Step 3: determining the second momentum correction

In step 3 the second correction to the momentum is determined. For gases the RHS has already been determined in `mafillsmv1rhs.f`, for liquids a term containing Δp has to be added to the value calculated in `mafillv1rhs.f` (this is done in `mafillv2rhs.f` and `e_c3d_v2rhs.f`). The lumped equations are solved and the solution is added to $\Delta \mathbf{V}^*$ (again in fields $v(1..nk,1)$, $v(1..nk,2)$ and $v(1..nk,3)$).

10.11.11 Step 4: determining the energy correction

In step 4 the correction to the energy is determined. The lumped equations have already been solved immediately after the call to `mafillsmv1rhs.f` and the solution was stored in field $v(1..nk,0)$. Step 4 is only performed for gases (which exhibit a strong coupling of density, temperature and pressure) and for liquids for which initial temperature conditions have been defined. In general the coupling in liquids is rather weak.

10.11.12 Step 5: determining the turbulence corrections

In step 5 the turbulence corrections are determined. This was already done immediately after the call to `mafillv1rhs.f` (only if the turbulence parameter on the `*CFD` card was set by the user).

10.11.13 Updating the conservative variables

In the previous five steps all corrections to the conservative variables have been determined. Now in subroutine `updatecfd.f`, these corrections, which were stored in field `v`, are added to the conservative variables at the start of the increment (stored in field `vcon(1...nk,0...mi(2))`). The sum is saved again in `vcon`, i.e. this field is updated.

10.11.14 Smoothing the conservative variables for gases

For gases the conservative variables ρ , $\rho\mathbf{V}$ and $\rho\epsilon_t$ are smoothed on basis of the local pressure gradient which was calculated in the previous fluid increment (subroutine `presgradient.f`). The smoothing is done in routine `smoothshock.f`. The primary parameter in the smoothing procedure is `shockcoef`, which can take values between 0 (no smoothing) and 2. This parameter can be set in the input deck on the *STEP card using the parameter `SHOCK SMOOTHING`. If the solution diverges (this is frequently characterized by the presence of NaN (Not a Number) in the solution, leading to negative time steps or the divergence of the conservative to physical conversion routine `con2phys.f`), the calculation is restarted with a shock smoothing coefficient twice the previous value (or a value of 0.001 if the previous value was 0). Once the value of 2 is exceeded, the program stops with an error message.

10.11.15 Determining the physical variables

Then, the physical variables are determined from the conservative ones in `con2phys.f` and stored in `vold(0...mi(2),*)`. The determination of the temperature T from $\rho\epsilon_t$ always requires the iterative solution of a nonlinear equation.

10.11.16 Application of BC's

The boundary conditions (Single Point Constraints and Multiple Point Constraints) are applied to the physical variables T , \mathbf{V} and p in routine `applybound-fem.f`. The same applies to the turbulence parameters k and ω , however, in that case the boundary conditions are not defined by the user in the input deck. Rather, they are automatically calculated based on the recommendations in [57] by CalculiX. Any change in the physical variables (in `vold`) is immediately transferred to the conservative variables (in `vcon`) too.

10.11.17 Calculation of the smoothing field

Based on the values of the pressure field and the shock smoothing coefficient a smoothing field `sa(1..nk)` is calculated, which is used for the shock smoothing in the next fluid increment. This only applies to compressible fluids.

10.11.18 Convergence check

Finally, the L_2 norm of the conservative variables and their increments is calculated for the convergence check. Right now, convergence is reached if the norm of the change of the conservative variables does not exceed 10^{-8} of the norm of the variables themselves. The quotient of these norms is stored in file `jobname.fcv` (increment number, $\rho\epsilon_t$, ρv_1 , ρv_2 , ρv_3 , p (incompressible) or ρ (compressible), ρk and $\rho\omega$ (only for turbulent calculations) and the size of the fluid time increment, in that order).

10.11.19 Result output

The results are stored in `printoutfluidfem.f`, `printoutfacefem.f` and `frdfluidfem.f`. Depending on the output requests additional information may have been calculated in `calcstressheatfluxfem.f`, `extrapolatefem.f` and `calcmach.f`. For what fluid increments the results are stored is controlled by the value of the parameter `FREQUENCYF` on the `*NODE FILE` etc... cards.

10.12 Sensitivity Analysis

The coding for sensitivity analysis is concentrated within the `sensi_coor.c` (coordinates as design variables) and `sensi_orien.c` (orientation as design variables) subroutines. The design responses and the parameters describing them are stored in a character*81 field `objectset(5,nobject)`, where `nobject` is the number of design responses.

The structure of the field `objectset` is as follows:

- `objectset(1,*)`
 - 1-18: design response (e.g. ALL-DISP)
 - 19-20: LE or GE (for constraints)
 - 21-40: boundary weighting distance
 - 41-60: relative constraint value
 - 61-80: absolute constraint value
 - 81-81: R for reading the sensitivities from file `jobname.sen`, W for writing the sensitivities to file `jobname.sen` (only stored in `objectset(1,1)`)
- `objectset(2,*)`
 - 1-5: filter type
 - 6-8: BOU if boundary weighting is active, else empty
 - 10-12: EDG if edge conservation is active, else empty
 - 14-16: DIR if direction weighting is active, else empty
 - 17-19: MIN for minimization, MAX for maximization

- 21-40: filter radius
- 41-60: ρ of the Kreisselmeier-Steinhauser function
- 61-80: $\bar{\sigma}$ of the Kreisselmeier-Steinhauser function
- objectset(3,*)
 - 1-81: node or element set to which the design response applies
- objectset(4,*)
 - set of opposite nodes (only for MAXMEMBERSIZE AND MINMEMBERSIZE geometric constraints)
- objectset(5,*)
 - 1-80: name of the design response
 - 81-81: C for Constraint, G for Geometric constraint and O for Objective

The structure of subroutines `sensi_coor.c` and `sensi_orien.c` is made up of a preprocessing part, a processing part and a postprocessing part. The preprocessing part is executed only once, for frequency sensitivities the processing and postprocessing part is executed as many times as there are eigenvalues, else they are executed only once.

10.12.1 Preprocessing the sensitivity

The Structure of the preprocessing part is shown in Figure 186. At first all elements belonging to one and the same node are determined and stored in the data structure shown in Figure 187. Then, the program flow is split according to whether the design variables are the coordinates or the material orientations.

For coordinate design variables the following steps are performed:

- The external faces of the structure are determined and stored in the data format explained in Figure 174 as well as in the data format shown in Figure 188 (`findextsurface.f`)
- All external faces to which a given node belongs are stored in fields `ipnoelfa` and `inoelfa` according to the data structure shown in Figure 189 (`extfacepernode.f`)
- The design variables (i.e. nodes) are stored in ascending order in field `nodedesi(*)`. The total number of design variables is `ndesi` (`getdesiinfo.f`)
- All elements belonging to one and the same design variable are stored in fields `istartdesi` and `ialdesi` according to the structure in Figure 190 (`elemperdesi.f`)

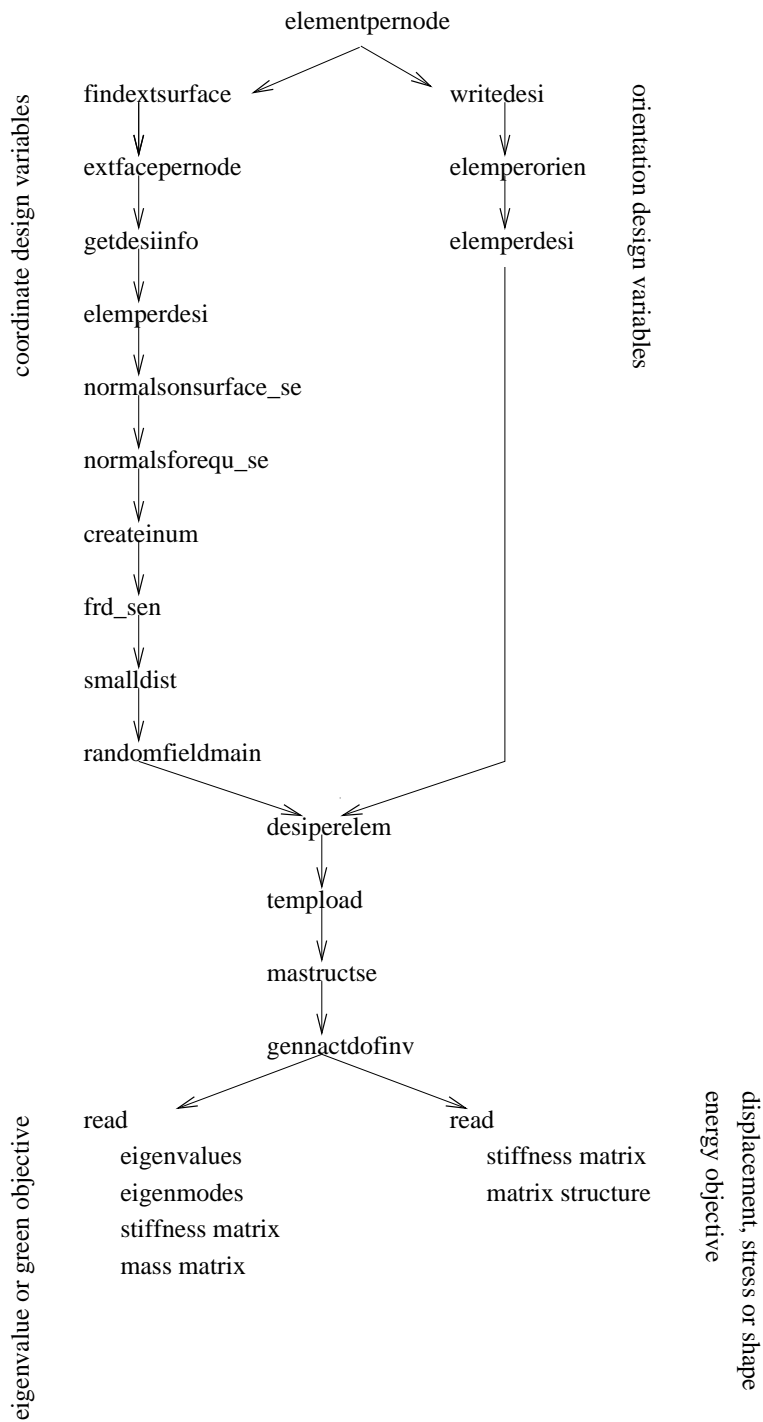

Figure 186: Structure of the preprocessing part

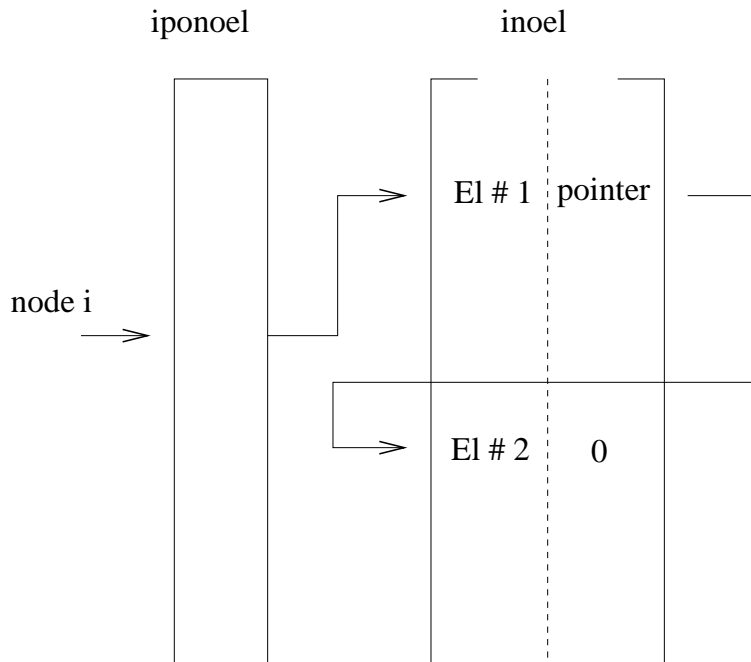

Figure 187: Data structure for all elements belonging to a given node

- The calculation of the normals to the external surfaces. At the design variables, this is the direction in which the nodes are moved and for which the sensitivity is calculated. In each node there can be only one normal. This is the mean of the normals on all external faces to which the node belongs. If the EDGE PRESERVATION=YES parameter is activated on the *FILTER card only external surfaces “internal” to the “domain” of design variables are taken into account for the calculation of the normal. An external surface is “internal” to the “domain” of more than half of its nodes are design variables (normalsonsurface.se.f).
- The calculation of the normals to the external surfaces. Although it seems to be the same task as in the previous item, it is not. The normals calculated here are needed for the mesh modifications in an optimization procedure. Usually the performance of a sensitivity study is not a goal itself, rather it is part of an optimization loop during which the sensitivities, which are nothing else than the derivative of the objective w.r.t. the design variables, are recalculated in each iteration and used in optimization strategies such as steepest descent or conjugate gradient. At the end of each iteration the design variables are moved a small amount in the normal direction (calculated in the previous item), all other nodes are not moved in normal direction. This deforms the mesh and may lead to bad elements. Hence the mesh has to be improved, e.g. with a Laplace opera-

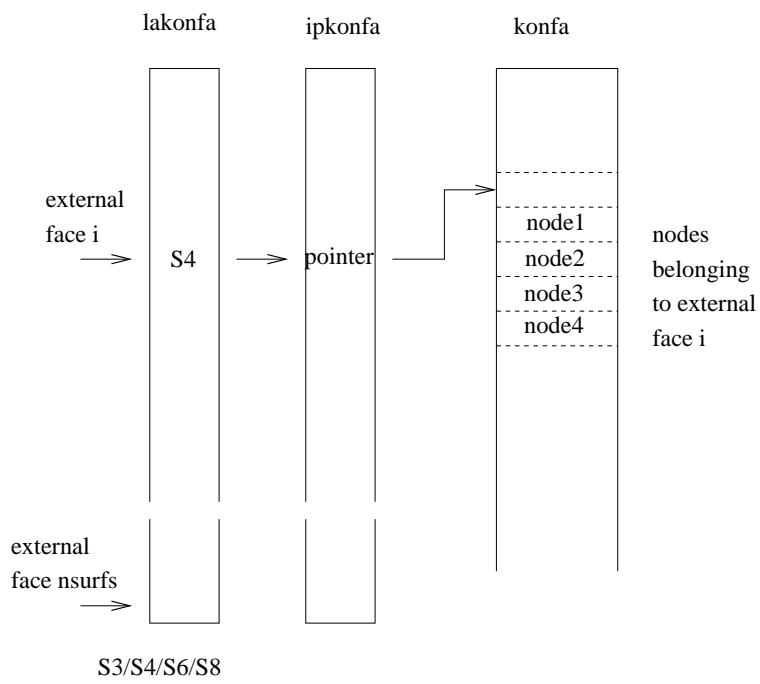

Figure 188: Data structure storing the kind of external face and the nodes belonging to that face

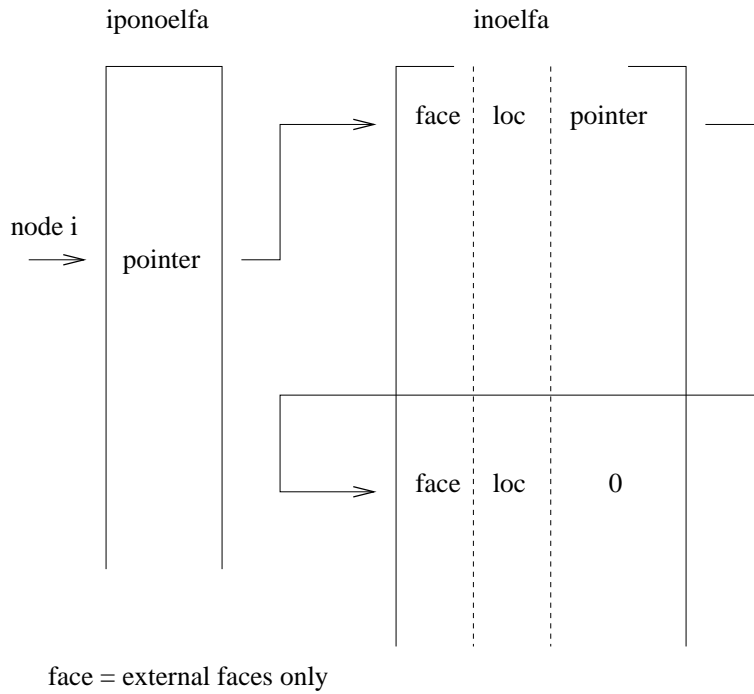

Figure 189: Data structure for all external faces belonging to a given node

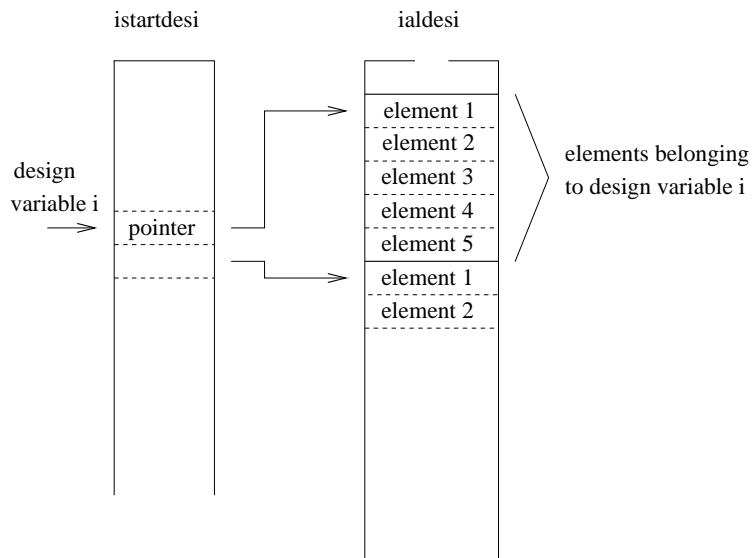

Figure 190: Data structure for all elements belonging to a specific design variable

tor. However, the external surface of the structure should not be changed during this operation. This latter requirement can be taken care of by defining multiple point constraints based on the local normal(s). Indeed, now more than one normal may be needed, e.g. at sharp corners which need be preserved. Therefore, the way the normals are determined here (normalsforequ.se.f) is different from the way this is done in normalson-surface.se.f. The equations are stored in the input deck jobname.equ for further use.

- Determination of the active nodes, i.e. the nodes belonging to elements (createinum.f) and storage of the normals determined in normalson-surface.se.f in frd-format in jobname.frd (frd_sen.c).
- Determination of the smallest distance distmin between two nodes belonging to one and the same element. Based on this distance a measure is derived ($\max(\text{distmin}/1.e6, 1.e-8)$) which is used to calculate the sensitivities on element-to-element basis with finite differences (smalldist.f).

For orientation design variables the following steps are performed:

- Storage of the orientation design variables in the jobname.dat file. Each local orientation leads to exactly three design variables, which are the components of the rotation vector describing the orientation (writedesi.f).
- Determining all elements corresponding to a given orientation. They are stored in fields ipoorel(*) and iorel(2,*) in exactly the same way as fields iponoel(*) and inoel(2,*) were used to store all elements to which a given node belongs, cf. Figure 187 (elemperorien.f).
- All elements belonging to one and the same design variable are stored in fields istartdesi and ialdesi according to the structure in Figure 190 (elemperdesi.f). This is analogous to the case in which the coordinates are the design variables.

The next four routines are common to coordinate design variables as well as orientation design variables:

- First the design variables per element are determined and stored in fields istartelem(*) and ialelem(*) in exactly the same way as fields istartdesi(*) and ialdesi(*) were used to store the elements per design variable according to Figure 190 (desiperelem.f).
- The actual external load is determined (tempload.f)
- The matrix structure of the sensitivity matrix df is determined and stored using the variables irows(*) and jqs(*). The sensitivity matrix is used to store $\frac{\partial F_{\text{ext}}}{\partial s}$, $\frac{\partial F_{\text{int}}}{\partial s}$, $\frac{\partial K}{\partial s} \cdot U$ or a combination of these. The dimensions are neq x ns, where neq is the number of independent degrees of freedom and ns is the number of design variables. This matrix is very sparse,

since only the degrees of freedom belonging to the nodes to which the design variable belongs will be nonzero. The nonzero's are stored column by column according to ascending row numbers for each column. Field `irows` contains the corresponding row numbers (size = total number of nonzero's), field `jqs(i)` contains the location of the first entry in `irows` belonging to column `i`.

- Each degree of freedom in field `df` corresponds to a specific direction in a specific node. In `gennactdofinv.f` field `nactdofinv(i)` is determined yielding the direction and node for a degree of freedom `i` in the form $(\text{node} - 1) * \text{mt} + \text{direction}$, where `mt` is the maximum number of directions (= `mi(2)`, cf. List of variables and their meaning) + 1.

At this point the preprocessing part is split according to whether the objectives are the eigenvalues or Green functions, in which case the eigenvalues, eigenmodes, stiffness matrix and mass matrix are read from file (generate in a previous `*FREQUENCY` or `*GREEN` step), or whether the objective is the mass, the stress or the shape energy, in which case the stiffness matrix and the matrix structure are read from file (generated in a previous `*STATIC` step).

10.12.2 Processing the sensitivity

The sensitivity is calculated in routines `results_se.c`, `mafillsmmain_se.c` and `objectivemain_se.c`.

In routine `results_se.c` $\frac{\partial F_{\text{int}}}{\partial s}$ is determined. For geometrically nonlinear calculations (parameter `NLGEOM` on the `*STEP` card) the unperturbed displacements leading to the internal force correspond to the displacements at the end of the previous static step, if any, augmented by the actual prescribed displacements. For linear geometric calculations the unperturbed displacements correspond to zero augmented by the actual prescribed displacements. Indeed, nonzero prescribed displacements lead to internal forces in linear calculations. Therefore, the term $\frac{\partial F}{\partial s}$ in Equation (797) can be replaced by $\frac{\partial F_{\text{ext}}}{\partial s} - \frac{\partial F_{\text{int}}}{\partial s}$ for linear calculations, noting that only nonzero initial displacement boundary conditions lead to internal forces (and not any previous displacements). The second reason why `results_se.c` has to be called for linear calculations too is that the material tangent $\frac{\partial S}{\partial E}$ at each integration point, which is needed in `mafillsmmain_se.c` for the set up of the stiffness matrix, is also determined in `results_se.c`.

Routine `mafillsmmain_se.c` calculates the derivative of the external forces and of the stiffness matrix (and similar matrices):

- For static nonlinear geometric calculations

$$\frac{\partial F_{\text{ext}}}{\partial s} \tag{922}$$

is calculated.

- For static linear calculations

$$\frac{\partial F_{\text{ext}}}{\partial s} - \frac{\partial K}{\partial s} \cdot U \quad (923)$$

is determined.

- For frequency and Green calculations

$$- \frac{\partial(K - \sigma M)}{\partial s} \cdot U \quad (924)$$

is calculated, where σ is an appropriately defined scalar.

Out of computational efficiency the latter terms are calculated at the element level and assembled into a global matrix thereupon.

The last major routine, `objectivemain.se.c` assembles the previous information to obtain the final sensitivity. For the orientation as design variable these sensitivities are immediately stored in the `.dat` or the `.frd` file. The sensitivity for the geometry (normal directions of nodes on the external surface) as design variable, however, is kept for further postprocessing in `sens.coor.c`.

For the objective G the total sensitivity $\frac{dG(s,U(s))}{ds}$ is written as $\frac{\partial G}{\partial s} + \frac{\partial G}{\partial U} \cdot \frac{\partial U}{\partial s}$. So the objective function is used in the terms $\frac{\partial G}{\partial s}$ and $\frac{\partial G}{\partial U}$. The routine `objectivemain.se.c` is split according to the objective function:

- The MASS objective function does not depend on the displacements, i.e. the deformation of a body does not change its mass. So only the first term in the above equation is needed. This term examines how the change of the design variables directly changes the mass. For the orientation as design variable the mass does not change at all. For coordinates as design variables, however, $\frac{\partial G}{\partial s}$ is appropriately calculated. This is done by determining G for the unperturbed geometry and for the geometry in which one of the design variables (the geometric change in normal direction in a node on the external surface) is changed by a small amount (finite difference approximation). The routine in which this is done is `objective_mass_dx.f`.

In general, the objective function does not have to apply to the total structure, e.g. one can define the mass of part of the structure as design variable. In that case all other elements are deactivated. This is done in routine `actideacti.f`. This applies to all objective functions, for which only part of the structure is included.

- For the STRAIN ENERGY as objective function a distinction has to be made whether the calculation is geometrically linear or nonlinear. For a linear geometric calculation Equation (798) reduces to:

$$\frac{DG}{Ds} = \frac{\partial G}{\partial s} + U \left(\frac{\partial F}{\partial s} - \frac{\partial K}{\partial s} \cdot U \right). \quad (925)$$

The first term on the right hand side is calculated in a similar way as for the MASS in routine `objective_shapeener_dx.f`. The term in brackets on the right hand side was already determined in `results_se.f` and `mafillsmmain_se.f`. Premultiplying it with the displacements from the previous static step and adding the first term yields the sensitivities (`objective_shapeener_tot.f`).

For a nonlinear geometric calculation Equation (798) reduces to:

$$\frac{DG}{Ds} = \frac{\partial G}{\partial s} + F_{\text{int}}^T K^{-1} \left(\frac{\partial F_{\text{ext}}}{\partial s} - \frac{\partial F_{\text{int}}}{\partial s} \right). \quad (926)$$

Now, $Y \equiv F_{\text{int}}^T K^{-1}$ is calculated by solving the set of equations $KY = F_{\text{int}}$. The remaining operations are similar to the linear case.

- For the EIGENFREQUENCY as objective function the sensitivity reduces to:

$$\frac{\partial \lambda_i}{\partial s} = U_i^T \cdot \left(\frac{\partial K}{\partial s} - \lambda_i \frac{\partial M}{\partial s} \right) \cdot U_i. \quad (927)$$

The part starting with the brackets on the right hand side has been determined in `mafillsmmain_se.f`. Consequently, the sensitivity of the eigenfrequencies only requires the premultiplication with the eigenmodes. This is done in `objective_freq.f` and `objective_freq_cs.f` (cyclic symmetry).

For the sensitivity of the eigenmodes (only calculated for the orientation as design variable) the relevant equation is Equation (802), which can also be written as:

$$(K - \lambda_i M) \frac{\partial U_i}{\partial s} = F_i. \quad (928)$$

Assuming the sensitivity to be a linear combination of the eigenmodes:

$$\frac{\partial U_i}{\partial s} = \sum_j c_j U_j, \quad (929)$$

leads to the following expressions for c_j :

$$c_j = \frac{U_j^T F_i}{\lambda_j - \lambda_i}, i \neq j \quad (930)$$

and $c_i = 0$. The latter equation results from the differentiation of the mass normalization condition $U_i^T M U_i = 1$. Indeed, one obtains:

$$2 \left(\frac{\partial U_i}{\partial s} \right)^T M U_i = 0, \quad (931)$$

since M is symmetric and not dependent on the orientation of the material. This means that $(\frac{\partial U_i}{\partial s})^T$ is orthogonal to U_i . Mathematically, this can also be interpreted as follows: the solution of Equation (928) can be seen as a particular solution complemented by an arbitrary multiple of the homogeneous solution. The homogeneous solution is U_i , a particular solution is obtained by a linear combination of the other eigenmodes, which are orthogonal to U_i (since K and M are symmetric). Now, Equation (931) expresses that the solution is orthogonal to U_i , so only the particular solution with coefficients from Equation (930) remains.

The determination of

$$F_i = - \left(\frac{\partial K}{\partial s} - \lambda_i \frac{\partial M}{\partial s} - \frac{\partial \lambda_i}{\partial s} M \right) \cdot U_i \quad (932)$$

is straightforward and is based on the expression calculated in `mafillsm-main_se.f` and the sensitivity of the eigenfrequencies.

- For the sensitivity of the Green functions (only calculated for the orientation as design variables) the relevant equation reads:

$$(K - \omega_0^2 M) \frac{\partial U_i}{\partial s} = \frac{\partial K}{\partial s} \cdot U_i. \quad (933)$$

and requires the solution of a system of equations for each design variable. The system matrix, however, does not change, so the LU-decomposition of the matrix has only to be done once.

For the orientation as design variable the frequency sensitivities are stored in the `.dat` file, whereas the sensitivities of the eigenmodes and/or Green functions are stored in the `.frd` file (`frd_sen.c`, called from `objectivemain_se.c`). For the geometry as design variable only the frequency sensitivities are determined. They are not stored in `objectivemain_se.c` since they may need further postprocessing in `sensi_coor.c`.

- The ALL-DISP objective function is differently defined for orientation design variables than for geometric design variables. The processing, however, is similar. The relevant equation is

$$\frac{\partial U}{\partial s} = K^{-1} \left(\frac{\partial F_{\text{ext}}}{\partial s} - \frac{\partial F_{\text{int}}}{\partial s} \right), \quad (934)$$

for geometrically nonlinear calculations and

$$\frac{\partial U}{\partial s} = K^{-1} \left(\frac{\partial F}{\partial s} - \frac{\partial K}{\partial s} \cdot U \right) \quad (935)$$

for geometrically linear calculations. In both cases the term in brackets on the right hand side (let us call it F) has been calculated before. Therefore,

the complete right hand side is determined by solving $KY = F$ for each design variable. Since the matrix of the system does not depend on the design variable, it has only to be LU-decomposed once.

For orientation design variables the result is transferred from the degrees of freedom to the (node,direction) representation in `resultsnoddir.f` and stored in the `.frd` file in `frd_sen.c`. For geometrical design variables the result is processed in `objective_disp_dx.f`. This is due to the fact that the displacement geometric function for geometrical design variables is defined as the square root of the sum of the square of the displacements in all design nodes. After leaving `objective_disp_dx` the result is kept for further postprocessing.

- Results for the MISESSTRESS, PS1STRESS or PS3STRESS as objective are immediately based on Equation (798). Here too, one can write an equation of the form:

$$S = f(U(s), s), \quad (936)$$

i.e. the stress S is in general a direct function of the design variables and an indirect function through the displacements. Indeed, the stress is the result of the “multiplication” of the material constants with the derivative of the displacements with respect to the geometry.

For geometrical design variables both terms $\partial S/\partial s$ and $\partial S/\partial U$ have to be evaluated, i.e. keeping the displacements at the nodes constant while changing the geometry will lead to stress changes, as well as changing the displacements while keeping the geometry constant.

For orientation design variables $\partial S/\partial s = 0$ since the stress change only comes through the material law.

For geometrical design variables the stress in the unperturbed state is calculated in `resultsstr.c`, while the derivative w.r.t. s is done in `stress_sen_dx.f` and the derivative w.r.t. U in `stress_sen_dv.f`. The calculation of Equation (798) is done exactly as explained in Section 6.9.23 from left to right, i.e. first calculating $(\partial G/\partial s)K^{-1}$ before continuing with the expression in brackets.

For orientation design variables the sensitivity can be written as

$$\frac{\partial S}{\partial s} \approx \frac{S(U(s + \Delta s), s + \Delta s) - S(U(s), s)}{\Delta s}, \quad (937)$$

where $U(s + \Delta s)$ is approximated by

$$U(s + \Delta s) \approx U(s) + \frac{\partial U}{\partial s} \Delta s. \quad (938)$$

So the stress sensitivities require the knowledge of the displacement sensitivities. This was treated in the previous item. For orientation design

variables the above operations require the routines `resultsnoddir.f` and `resultsstr.c` (and their subroutines). The results (i.e. the sensitivity of the von Mises stress at all nodes w.r.t. a change in an anisotropic orientation) are stored in the `frd`-file.

- Results for MODALSTRESS as objective are also based on Equation (792), but now Equation (929) is used for $\partial U_i / \partial s$. Right now MODALSTRESS can only be used for geometric sensitivities. Therefore, $\partial M / \partial s \neq 0$ and Equation (931) has to be replaced by:

$$2 \frac{\partial U_i^T}{\partial s} M U_i = -U_i^T \frac{\partial M}{\partial s} U_i, \quad (939)$$

and c_i now satisfies:

$$c_i = -\frac{1}{2} U_i^T \frac{\partial M}{\partial s} U_i, \quad (940)$$

instead of being zero. Defining

$$\alpha_j = \frac{\partial S}{\partial U_i} U_j, \quad (941)$$

one obtains for the stress sensitivity for mode i :

$$\frac{dS}{ds} = \frac{\partial S}{\partial s} + c_i \alpha_i + \sum_{j \neq i} \left(\frac{\alpha_j}{\lambda_i - \lambda_j} \right) \left[U_j^T \frac{\partial F_i}{\partial s} \right]. \quad (942)$$

- The THICKNESS objective can only be used as a constraint to another objective function. For a LE constraint the sensitivity is 1 if the actual thickness exceeds the reference thickness, else it is 0. For a GE constraint the sensitivity is 1 if the actual thickness is less than the reference thickness, else is 0.

10.12.3 Postprocessing the sensitivity

Postprocessing is only done for geometrical design variables. The postprocessing procedure is coded in `sensi.coor.c` and `feasibledirection.c` and consists of the following steps:

- Changing from a shape function smeared sensitivity representation to local sensitivities (`sensi.coor.c`).
- For quadratic elements: interpolating the sensitivities at the middle nodes to the vertex nodes (`sensi.coor.c`).
- Backward filtering the sensitivities (`sensi.coor.c`).

- Calculating the geometrical constraints defined for the design variables (feasibledirection.c).
- Modifying the sensitivities due to constraint conditions (feasibledirection.c).
- Forward filtering of the sensitivities (feasibledirection.c).
- Creating a transition region from the design node region to its complement (feasibledirection.c).

Now the steps are treated in more detail:

- The sensitivity for geometric design variables is calculated by moving each design variable an infinitesimal distance in a direction normal to the external surface. Through the shape functions this motion extends across an area consisting of all external faces to which the design node belongs. The sensitivity is localized through division by the integral of the shape functions taking the value 1 at the node at stake (distributesens.f).
- For quadratic faces frequently a checkerboard pattern arises for the sensitivities. For this type of elements it has proven advantageous to disregard the sensitivities calculated at the vertex nodes. They are replaced by an interpolation of the values at the midnodes of all external design faces (quadraticsens.f).
- The filtering which is done after the sensitivity analysis and after the calculation of the feasible direction follows the idea of vertex morphing. This means that conceptually an additional control field z , apart from the design variables s , is introduced with the size of the number of design variables on which the mathematical optimization problem is solved. This control field is connected with the design variables by the following formula

$$\frac{DG(z, s(z))}{Dz} = \frac{\partial G}{\partial z} + \frac{\partial G}{\partial s} \frac{\partial s}{\partial z} = \frac{\partial G}{\partial s} \frac{\partial s}{\partial z}. \quad (943)$$

Since a change in control field does not alter the geometry and hence the design response G , the partial derivative $\partial G/\partial z = 0$. The expression $\partial s/\partial z$ can be regarded as a smoothing operator (filter) between the design variables and the control field. In vertex morphing this filtering operation has to be done twice. First, after the sensitivity analysis (sensi_coor.c), called backward filtering, in order to transform the sensitivities calculated at the design variables to the control field. The output in the frd file is the unfiltered sensitivity at the design variables as well as the filtered one, which can be interpreted as the sensitivity on the control field. And a second time to map the final feasible direction back to the nodal design variables, called forward filtering, which is done in feasi_bledirection.c. Again, two output fields are written in the frd file: the feasible direction calculated on the control field and the forward filtered feasible direction on the nodal design variables.

The filtering itself is implemented as an explicit filter. Independent if backward or forward filtering is done, the sensitivity values at a given node are thereby replaced by a weighted sum of the sensitivities of the nodes within a sphere with a user-defined radius. The weighting function is 1 at the node at stake and decreases radially in a user-defined way to zero at the edge of the sphere. The available filter functions are linear, quadratic, cubic and gauss. If the parameter DIRECTION WEIGHTING is active on the *FILTER card the sensitivity values at a node i are replaced by a weighted sum of the sensitivities at the nodes j within the sphere multiplied by the scalar product of the normal vector at j and the normal vector at i .

- If the parameter BOUNDARY WEIGHTING=YES is selected on the *FILTER card the sensitivities are linearly decreased to zero at the edge of the design domain. This edge is defined by all nodes which are not design variables but belong to external faces which contain at least one design variable. If a design node lies within a user-defined boundary weighting distance from this edge a linear reduction proportional to the actual distance is applied. This assures a smooth transition of the sensitivities to zero at the edge of the design domain.

10.13 Mesh refinement

The mesh refinement procedure starts from the mesh in the input deck. All elements which are not of type C3D4 or C3D10 are kept and their element numbers are not modified. All other elements are deleted and the gaps in the numbering between the elements which are not tetrahedral are filled from low to high by the newly generated tetrahedral elements. The procedure for the refinement is based on the book by P.-L. George and H. Borouchaki [29].

The mesh refinement procedure uses a lot of mesh description fields, most of which are dynamically modified during the refinement. These fields are introduced first.

10.13.1 Nodal fields

The primary nodal field is `cotet(3,*)`, which contains the actual coordinates of the mesh. This includes the coordinates of these parts of the mesh which are not meshed by tetrahedral elements. During the refinement only nodes are created, existing nodes are not deleted. The actual maximum node number is `nktet`, the actual nodal allocation size is `nktet..`. Both numbers change during the refinement.

`iexternnode(*)` is a nodal field which indicates whether the node is on the surface (value 1) or internal (value 0). The field `h(*)` specifies the desired edge length at each node. Both these fields change dynamically during the refinement. The structure of fields `cotet(3,*)`, `iexternnode(*)` and `h(*)` is illustrated in Figure 191.

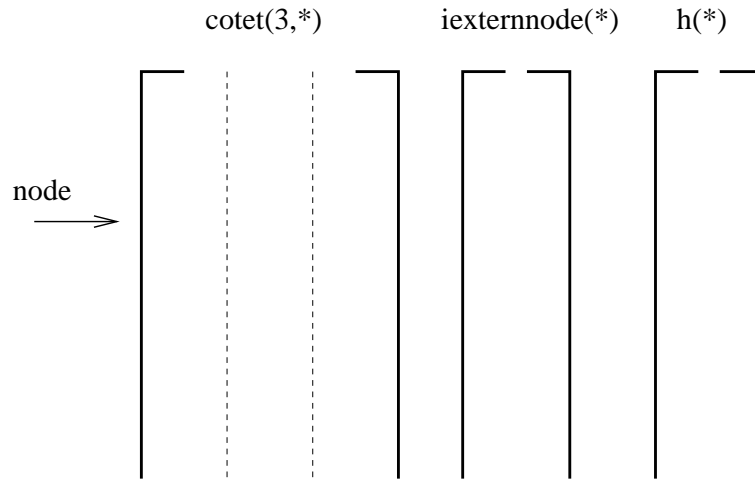

Figure 191: Nodal fields

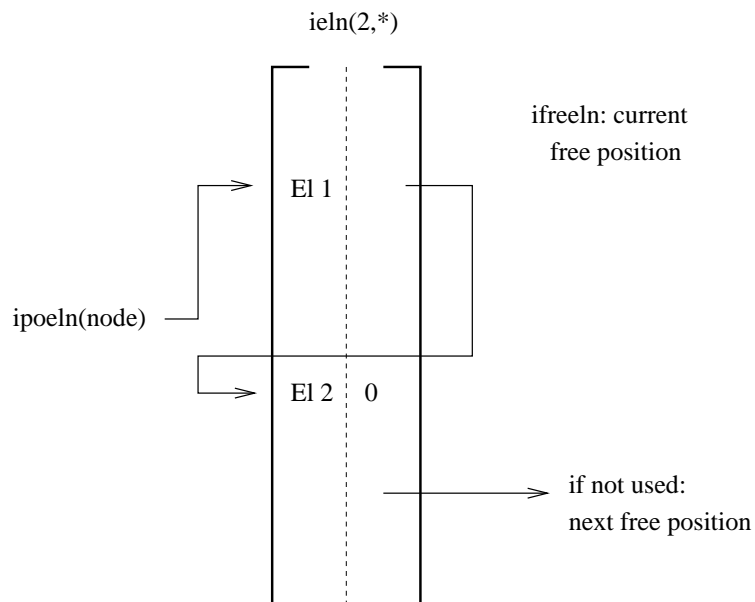

Figure 192: Element per node relationship

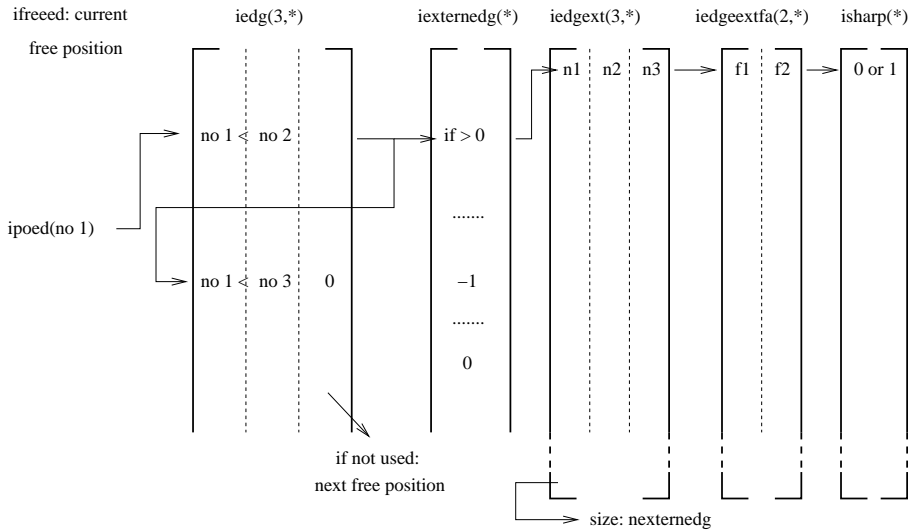

Figure 193: Node per edge relationship

Finally, the fields ipoeln and ieln are used to specify the elements containing a specific node (Figure 192). For a node i the value ipoeln(i) points to an entry ieln(1,ipoeln(i)) containing an element to which the node belongs. If there are more such elements, the next element is stored in ieln(1,ieln(2,ipoeln(i))) and so on until ieln(2,ieln(2,...,ipoeln(i)))=0. At any time during the scalar ifreeln contains the next free position in ieln, whereas the entry ieln(2, j) for any not used position j in the field points to a next free position.

10.13.2 Edge fields

During the mesh refinement no middle nodes are considered. Consequently, edges only contain two nodes. They are numbered according to their storage in field iedg(1..3,*) (Figure 193). In this field entry iedg(1, i) contains the first node of edge i and iedg(2, i) contains the second node, such that iedg(1, i) < iedg(2, i). For a node j ipoed(j) points to an edge in field iedg for which j is the smallest node number. If there is more than one such edge iedg(3, i) points to the next entry in iedg containing an edge for which j is again the smallest node number. If no more such edge exists the value of iedg(3,...)=0. This is a construct similar to field ieln. An actual free entry in field iedg is pointed to by ifreed, and for any free line k iedg(3, k) points to a next free line.

Fields containing a similar number of lines as iedg are $d^{(*)}$ containing the length of the edges, $n^{(*)}$ containing the number of new nodes to be inserted on the edge for the mesh refinement (can only take the value 0 or 1 in each iteration depending on whether a node is to be inserted), $r^{(*)}$ containing the bias for the node insertion (if any) and iedgmid(*) containing the number of the midnode on the edge. The latter field is only introduced at the end of the

mesh refinement (in `projectnodes.f`) and only if quadratic tetrahedral elements are requested. Finally, there is the field `ixternedg(*)` which takes the value:

- -1 if the edge is external but is not part of an edge of the unrefined mesh
- 0 if the edge is not external
- $i > 0$ if the edge is external and part of an external edge i of the unrefined mesh. This edge i is described by its nodes n_1 , n_2 (middle node, if any, else 0) and n_3 which are stored in field `iedgext(1..3,i)`. Field `iedgext` is a static field (i.e. it does not change during refinement) since it describes the unrefined mesh. Entries `iedgeextfa(1..2,i)` are the two external faces to which external edge i belongs. Data on these external faces, e.g. $j = \text{iedgeextfa}(1,i)$ is stored in `ifacext(1..6,j)` and `ifacexted(1..3,j)`. These fields are discussed in the face field section. Finally, `isharp(i)` indicates whether an external edge is sharp. Whether an external edge is sharp is decided on at the end of the refinement at the time of the node projection. An external edge is sharp if
 - it is used as parent edge for at least one newly generated edge during mesh refinement AND
 - the normals on the adjacent external faces have an angle of less than about 0.05° .

Fields `iedgeextfa`, `ifacext`, `ifacexted` and `isharp` are static, the contents of field `isharp`, however, is modified at the end of the refinement in routine `projectnodes.f`. All of these fields are needed for the projection of the newly generated nodes after mesh refinement.

The last fields `ipoeled(i)` and `ieled(2,*)` point to the elements to which edge i belongs in the same way the element per node relationship is stored in `ipoeln(*)` and `ieln(2,*)`, Figure 194.

10.13.3 Face fields

Faces are stored in field `ifac(1..4,*)`. For a given node i `ipofa(i)` points to a face in `ifac` for which i is the lowest node number. The node numbers of this face are stored in entries `ifac(1..3,ipofa(i))` in ascending order. The entry `ifac(4,ipofa(i))` points to another face for which node i is also the lowest node, if any. If there exists no face for which i is the lowest node number `ipofa(i)=0` (Figure 195). The scalar `ifreefa` points to a free entry in field `ifac`. For any line j in `ifac` which is not used yet `ifac(4,j)` points to the next free entry.

Other fields with a similar number of lines as `ifac` are `itetfa`, `planfa` and `ixternfa`. They contain:

- `itetfa(1..2,i)`: the tetrahedral elements to which face i belongs. For an external face the second entry is zero.

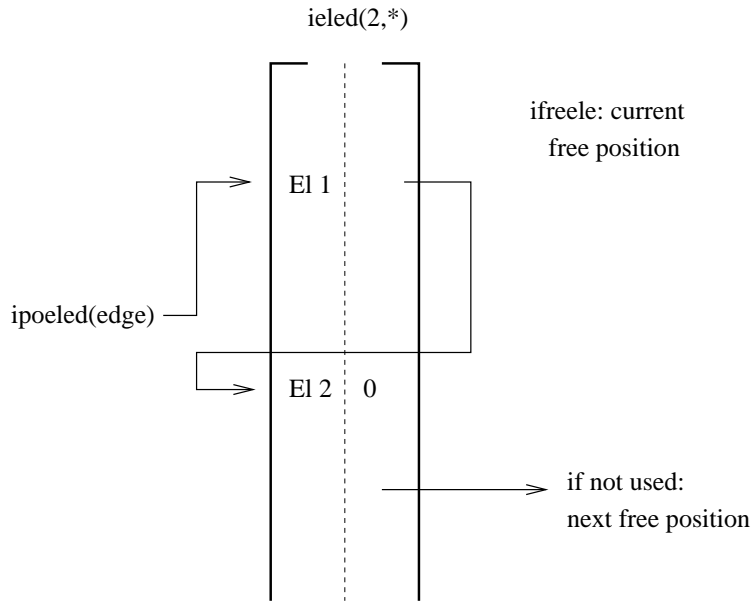

Figure 194: Element per edge relationship

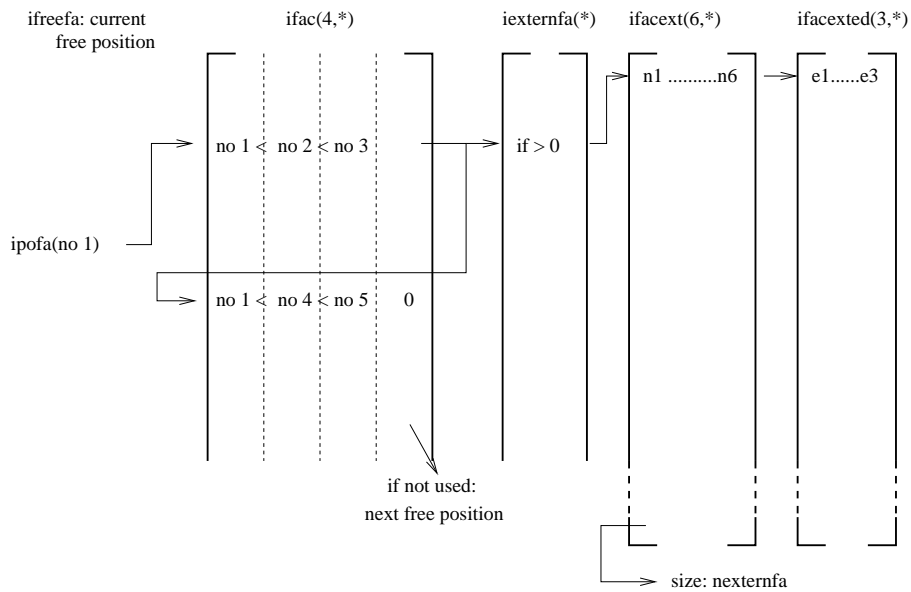

Figure 195: Node per face relationship

- `planfa(1..4,i)`: the equation of the face in the form $ax+by+cz+d=0$, with $\|(a, b, c)\| = 1$.
- `iexternfa(i)`: takes a nonzero value j for an external face, else zero. A nonzero value points to a parent external face (an external face belonging to the unrefined mesh) which is in the immediate neighborhood of face i . The parent external face information is stored in fields `ifacext(1..6,*)` and `ifacexted(1..3,*)`. These fields are static and created at the start of the refinement. `ifacext(1..6,j)` contains the nodes belonging to face j , `ifacexted(1..3,j)` contains the external edges belonging to the face. Information on these external edges, e.g. external edge j , is stored in `isharp(j)`, `iedgext(1..3,j)` and `iedgeextfa(1..2,j)`. The reader is referred to the previous section for information on these fields. All of these fields are needed for the nodal projection at the end of the refinement.

All these fields (except the external ones) are dynamically adjusted during mesh refinement.

10.13.4 Element fields

The topology of the tetrahedral elements is stored in field `kontet(1..4,*)`. This field is dynamically updated during mesh refinement. The next free entry in `kontet` is pointed to by `ifreetet`, the entries `kontet(4,*)` of entries in the field which have not been used yet point to a next free entry. The field `kontet` is special in the sense that element numbers in the unrefined mesh which are no tetrahedral elements cannot be used for newly generated tetrahedral elements, i.e. the element numbers of such elements are kept. At the start of the mesh refinement the tetrahedral elements are renumbered such that they occupy the lowest possible element numbers. The corresponding middle nodes of these elements, if any, are stored in field `kontetor(1..6,*)`. The field `kontetor` is static, i.e. it only contains the middle nodes of the quadratic tetrahedral elements of the unrefined mesh. This field is used to calculate field `ifacext` and is discarded immediately afterwards.

Fields with the same number of lines as `kontet` are `ifatet(1..4,*)`, `bc(1..4,*)`, `cg(1..3,*)` and `iedtet(1..6,*)`. They contain:

- `ifatet(1..4,*)`: the numbers of the faces belonging to the tetrahedral element. The order corresponds to Figure 196. The sign of the face number is the sign of the expression for the face equation in which the coordinates of the node opposite to the face (within the same element) were substituted.
- `bc(1..4,*)`: `bc(1..3,*)` contains the coordinates of the center of the circumscribed sphere of the element, `bc(4,*)` contains its radius.
- `cg(1..3,*)`: contains the coordinates of the center of gravity of the element.
- `iedtet(1..6,*)`: contains the number of the edges belonging to the element corresponding to the order in Figure 196.

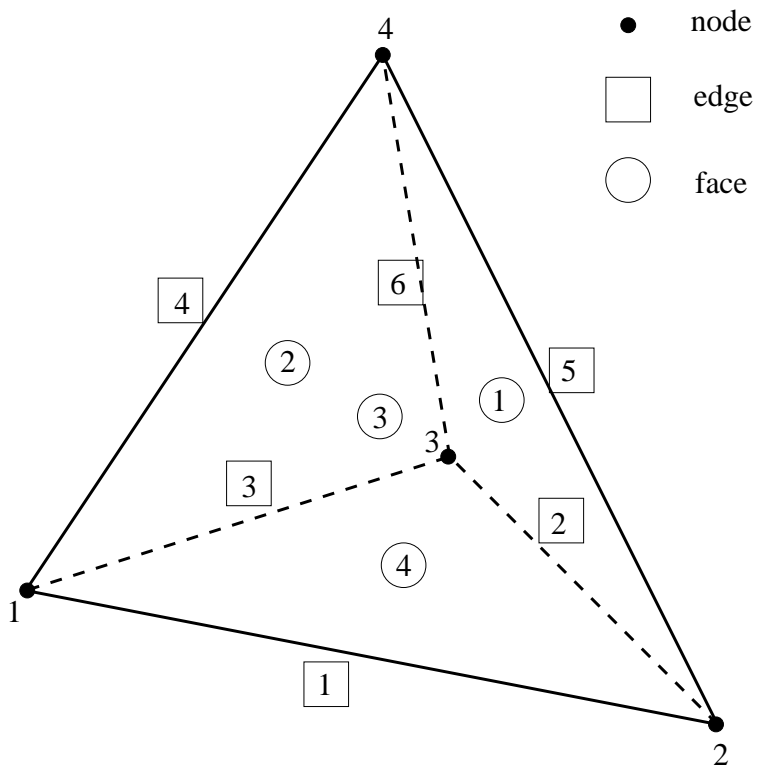

Figure 196: Node, edge and face numbering within a tetrahedral element

All these fields are dynamic. The actual size used for allocation purposes is `netet_`.

10.13.5 Mesh refining procedure

In this section the procedure how the mesh is refined is explained in detail. Figure 197 shows the global picture. The `refinemesh.c` routine is a subroutine of routine `frd.c`, which is used for the general `frd`-output. At first the following routines are called (in this section “element” and “tet” are used as synonyms):

cattet.f In this routine the unrefined tetrahedral mesh is catalogued. It consists of the following tasks:

- initialize `kontet` (take non-tet elements into account, close the gaps in the tet numbering)
- determine the nodes/tet relationship (`kontet`)
- calculate the circumscribed spheres of the tets (`bc`)
- calculate the center of gravity of the tets (`cg`)
- determine the tets/node relationship (`ieln`)
- catalogue the faces in `ifac`: nodes/face relationship
- determine the face equations (`planfa`)
- determine the faces/tet (`ifatet`)
- determine the tets/face (`itetfa`)

Notice that the tetrahedral elements are stored as if all of them were linear, i.e. C3D4-elements. The only quadratic information of the unrefined mesh is stored in fields `iedgext` and `ifacext`, to be discussed below.

catedges.f This routine catalogues the edges. This includes:

- catalogue the nodes/edge relationship (`iedg`)
- determine the element/edge relationship (`ieled`)

determineextern.f Next, the external nodes, edges and faces are identified.

A face is external if it belongs to only one element. If the face is external `iexternfa(i)` is set to 1, else it is 0.

All nodes in an external face are external. For these nodes `iexternnode` is set to 1, else it is 0.

All edges in an external face are external. The value for these edges in `iexternedg` is at first set to 1, else it is 0.

midexternaledges.f Nodes generated on external sharp edges of the unrefined mesh are after the refinement projected onto the unrefined external edges (in `projectvertexnodes.f` and `projectmidnodes.f`). These edges may be quadratic. In routine `midexternaledges.f` the external edges are stored in consecutive order (no gaps in the numbering) in field `iedgext(1..3,*)`. The second entry is the middle node, if any, else this entry takes the value 0. Now, for those edges i for which `iexternedg(i)=1` at the start of the routine (i.e. the external edges) `iexternedg(i)` is changed to j , where j is the number of the external edge in field `iedgext`.

Field `iexternedg` is dynamic, i.e. it is changed during the mesh refinement. If an edge i is remeshed in two new sub-edges (due to the insertion of a node) and if this edge is external, the value of `iexternedg(i)` is inherited by the sub-edges it is split into.

midexternalfaces.f Nodes generated on the exterior of the body and which do not belong to external sharp edges of the unrefined mesh are projected onto the unrefined surface at the end of the remeshing routine (in `projectvertexnodes.f` and `projectmidnodes.f`). To that end the external face information of the unrefined mesh is first copied from field `iexternfa` into `iexternfaor` (or for “original”). Then, the value of 1 in `iexternfaor(i)` for the external faces i is replaced by a value j , pointing to the entries `ifacext(1..6,j)` containing the six nodes of the face (node numbering as in Figure 66. The number of external faces is called `nexternfa` (= number of lines in field `ifacext`). The combination of field `iexternfaor` and `ifacext` allows the program to

- determine whether a face of the unrefined mesh was external
- what nodes are contained in this face (including the middle nodes).

The elements in the unrefined mesh adjacent to the external faces are stored in element set `ialsete`, the number of such elements is called `nexternal`.

At this point the preliminary work is finished and the major refinement loop starts. It consists of two parts: refinement of the external edges followed by the refinement of the internal edges.

START OF MAJOR LOOP

first loop: calculateth.f The first time the loop is run, the tetrahedral mesh is still the unrefined mesh. The following actions are performed in `calculateth.f`:

- determine the length of each edge and store it in field `d(*)`
- determine for each node the mean length of the edges to which it belongs. Multiply this value with the limit value specified by the user and divide it by the actual value of the user-defined criterion. Store the resulting value in field `h(*)`. For instance, if the user has selected the stress criterion, the limit value is 50. and the actual stress value in the node is 200.,

then an average edge length in the node of 0.1 will lead to a value of 0.025 in this node, i.e. the desired edge length is locally 0.025. Notice that the refinement information is stored in `filab(48)`, which is a character string of length 87. In positions 1:2 “RM” is stored, the field to which the refinement criterion applies is stored in positions 3:6, the limit in positions 7:26 (`f20.0`) and the element set to be refined in positions 27:87.

- determine the minimum value of $d^{(*)}$ across the complete mesh and store it in d_{min} .

first loop: getlocalresults.f In `getlocalresults.f` the global mesh is stored together with the $h^{(*)}$ values for later interpolation, i.e. to determine the h -value of a newly generated node an interpolation is performed within the h -values of the unrefined mesh. To this end the tetrahedral elements are numbered consecutively. The procedure is similar to the submodel interpolation procedure with the parent elements identical to the tetrahedral elements and the field `ielemnr` containing the non-consecutive numbering of the tetrahedral elements.

all but the first loop: calculated.f For the second and further loops the field $d^{(*)}$ containing the length of the edges and d_{min} are recalculated. The h -field is obtained by interpolation within the unrefined mesh.

START OF THE REFINEMENT OF THE EXTERNAL EDGES

edgedivide.f An external edge i with length d and h -values at its nodes of h_1 and h_2 is divided into $n(i)+1$ edges satisfying:

$$n(i) = \min \left\{ \text{int} \left[\frac{d}{\left(\frac{h_1+h_2}{2}\right)} - 1 \right], 1 \right\}, \quad (944)$$

where $\text{int}(x)$ is the integer smaller than or equal to the real number x . This creates at most 2 edges out of 1.

newnodes.f This routine contains a loop over all edges. For each edge i which is to be divided into two sub-edges the following actions are taken:

- determine the coordinates of the new node on the edge and store them in a consecutively arranged field `conewnodes(1..3,*)` with the total number of new nodes stored in the scalar `mnewnodes`. Let us assume that edge i is the j -th edge to be subdivided, then the coordinates are stored in `conewnodes(1..3,j)`
- determine a base element to which the edge belongs (an arbitrary element of the shell of the edge) and store the number in `ibasewnodes(j)`
- store the edge number on which the nodes lies (i.e. here i) in field `iedgnewnodes(*)`, i.e. `iedgnewnodes(j)=i`.

- determine the value of the h-field in the new node by interpolation within the unrefined mesh and store it in `hnewnodes(j)`

After leaving `newnodes` a random contribution is added to the coordinates of each new node while moving them towards the center of gravity of their base element (=perturbation of the nodal position from a surface position to a subsurface position). This ensures that each new node lies within a tetrahedral element and not on its faces or edges. This facilitates the insertion of the new nodes in the existing mesh and is particularly important for the newly created external surface nodes. Indeed, the insertion procedure explained in [29] works only for nodes not lying on the external surface. The insertion of the new nodes is done one by one after reordering them in an aleatoric way.

cavityext.f The insertion of each node is performed in `cavityext` in the following way:

- determine the cavity for the new node
 - start from the base element
 - add elements one by one through adjacency; only elements whose circumcircle enclose the new node are taken into account
 - check for nodes within the cavity; if any, remove the element to which they belong from the cavity
 - restore the unperturbed coordinates of the new node
 - connect the new node with each of the faces bordering the cavity and check the quality of the ensuing element. If
 - * the volume is not extremely small AND
 - * at least one height (a tetrahedral element has 4 heights) is very small compared to the desired element size at the new node's position AND
 - * the face bordering the cavity is external,
 then the cavity element bordering this face is removed, provided it is not the base element.
 - revert to the perturbed coordinates of the new node
 - check that the cavity is convex in the sense that each cavity face is visible from the new node, else the element bordering the face is removed from the cavity
 - restore the unperturbed coordinates
- remove the cavity elements
- create new elements connecting the new node with each of the cavity faces provided the resulting volume is not extremely small. If it is, no element is created and the sign of the face is inverted thus marking the zero volume elements

- if any element has a very small volume or at least one very small height the original mesh of the cavity is restored
- since elements have been deleted and created the base element numbers of the nodes still to be inserted may not be correct any more: perform a check on these nodes and correct the base element numbers if necessary.
- label the newly generated faces and edges as external or not. Sub-edges of the edge on which the new node was inserted inherit the label from field `iexternaledg`
- for negative cavity faces:
 - loop over all their edges and check whether they are still needed (i.e. still belong to another face)
 - remove the face

START OF THE REFINEMENT OF THE INTERNAL EDGES.

The procedure to refine the internal edges is similar to the one for the external edges. Here too routines `edgedivide.f` and `newnodes.f` are called. The new nodes are perturbed similarly as for the external edges and reordered in an aleatoric way. Just the insertion of the nodes in `cavity.f` is more simple:

cavity.f It is done in the following way:

- determine the cavity for the new node
 - start from the base element
 - add elements one by one through adjacency; only element whose circumcircle enclose the new node are taken into account
 - check for nodes within the cavity; if any, remove the element to which they belong from the cavity
 - check that the cavity is convex in the sense that each cavity face is visible from the new node, else the element bordering the face is removed from the cavity
- remove the cavity elements
- create new elements connecting the new node with each of the cavity faces
- if any element has a very small volume or at least one very small height the original mesh of the cavity is restored
- since elements have been deleted and created the base element numbers of the nodes still to be inserted may not be correct any more: perform a check on these nodes and correct the base element numbers if necessary.

SMOOTHING THE MESH At the end of each refinement iteration (in which at most one node is inserted on any edge) the mesh is smoothed. To this end three routines are called:

catnodes.f In the smoothing procedure the position of a node i is replaced by a weighted average of the position of its neighbors. In principal, all nodes belonging to the ball of node i (the ball of a node is by definition the set of element to which this node belongs [29]) are neighbors. However, for some nodes this set is further restricted. In general, a node j belonging to the ball of node i is a neighbor of node i if:

- node i is internal OR
- node i is external, node j is external and no sharp edges are attached to node i OR
- node i is external, node j is external and the edge connecting both is sharp.

Thus, the neighbors of an external node must also be external, else the weighted average “pulls” the node into the interior of the body, which is not beneficial. For the storage of the neighbors fields `iponn(*)` and `inn(2,*)` are used. The neighbors of node i are calculated in `catnodes.f` (“catalogue nodes”) and are stored in `inn(1,iponn(i),)`, `inn(1,inn(2,iponn(i)),` `inn(1,inn(2,inn(2,iponn(i))),` ... until `inn(2,inn(2,.....)))=0`. In this context also field `idimsh(*)` is used: `idimsh(i)` is the number of sharp edges connected to node i . Sharp edges are by definition external edges in the unrefined mesh the normals on the adjacent faces of which make an angle exceeding 0.0464° (determined in `checksharp.f`).

meshquality.f In this routine the quality of each element is determined. To this end the ratio of the largest edge L_i to the radius of the inscribed sphere is used. One can prove that the radius of the inscribed sphere of a linear tetrahedral is three times the volume V_i divided by the sum of the area of its faces $(\sum S)_i$ [29]. Therefore, the quality Q_i for element i can be written as:

$$Q_i = \frac{\sqrt{6}}{12} \frac{L_i(\sum S)_i}{3 \max(V_i, 10^{-30})}. \quad (945)$$

The factor $\frac{\sqrt{6}}{12}$ is such that the quality of an equilateral tetrahedron is 1. For all other tetrahedra it exceeds 1. The larger the value, the worse the element. The cut-off of 10^{-30} was introduced to avoid dividing by zero or getting a negative value.

smoothingvertexnodes.f After smoothing a node its position \mathbf{P}_i has changed into \mathbf{P}_i^* satisfying:

$$\mathbf{P}_i^* = \omega \frac{\sum_j \frac{1}{h_j^2} \mathbf{P}_j}{\sum_j \frac{1}{h_j^2}} + (1 - \omega) \mathbf{P}_i, \quad (946)$$

where j are the neighbors of i , $\bar{h}_j := (h_i + h_j)/2$ (h_i is the desired edge length in node i) and ω is a relaxation factor taking the value of 0.5. Defining the quality of the ball to be the quality of its worst element (i.e. highest value), a node i is only smoothed if the quality of its ball after smoothing has a smaller value (i.e. is better) than before smoothing.

END OF MAJOR LOOP.

projectvertexnodes.f After inserting nodes in several loops the external nodes are projected on the external edges and/or faces. If an edge i on which the node lies is part of an external edge of the unrefined mesh (i.e. $i\text{externedg}(i) > 0$) and this edge is sharp then a projection is performed on this external edge. If not, the node is projected on an external face. To this end the faces to which the node belongs are determined. For each of these faces j a check is performed whether the face is external (i.e. $i\text{externfa}(j) > 0$). If so, a projection is performed on the correct external face of the unrefined mesh. To this end a loop is performed starting with face $i\text{externfa}(j)$ using the adjacency relationships stored in fields $i\text{facexted}$ and $i\text{edgeextfa}$, until the correct face is found (i.e. the condition that the projection lies inside the face). While applying the adjacency relations field $i\text{sharp}$ is used to assure that sharp edges are not crossed.

Since projection may lead to bad elements it is performed in several loops. In each loop an increasing fraction of the motion from the actual position of the node to its projection on the external surface is performed. Each time a node is moved, the Jacobian determinant of all elements belonging to its ball is checked for positivity. If any Jacobian is negative, the size of the motion for this node in this iteration is decreased by half. If after three reductions there is still an element with a negative Jacobian the node is not moved at all in this iteration. If any reduction took place all nodes belonging to the ball are listed as bad nodes for further treatment in `smoothbadvertex.f`.

smoothbadvertex.f In `smoothbadvertex` the position of all subsurface bad nodes i (surface bad nodes are not moved!) is optimized using the optimizer `fminsi` [74] by minimizing the quality of the ball of i . So we are looking for a minimum of the function:

$$\max_{j \in \text{ball}_i} Q_j, \quad (947)$$

by modifying the position of node i , i.e. changing its x-, y- and z-coordinates (three parameters).

removesliver.f After projection so called sliver elements may exist, i.e. elements with nearly zero volume although the area of all their faces is finite [29]. These elements are removed. A sliver satisfies the following conditions:

- all its nodes are external AND

- the quality exceeds the value of 10 AND
- the element does not contain a sharp edge AND
- and it has at least 4 external edges.

CREATING QUADRATIC TETRAHEDRAL ELEMENTS. Linear tetrahedral elements usually perform not very well, unless you have an extremely dense mesh. Therefore, it is much better to resort to 10-node quadratic elements by inserting middle nodes on each edge. The external middle nodes have to be projected onto the external surface, which requires special attention. The following routines are dedicated to this job:

genmidnodes.f In this routine the middle nodes are created in the geometric middle of the end nodes of each edge. So there is a one-to-one relationship between the edges and the middle nodes. The middle node i on edge j is given by $i = \text{iedgmid}(j)$.

calculatehmid.f The desired edge length in the middle nodes (needed for the weighted smoothing) is obtained by interpolation between the end nodes.

searchmidneigh.f For the smoothing procedure neighbors have to be defined for each middle node. The neighbors of a middle node are the midnodes of all elements belonging to the shell of the middle node's edge. The shell of an edge are all elements containing this edge [29]. Here, the "midnode" is used as synonym for "middle node".

quadmeshquality.f Recall that the smoothed position of a vertex node is only accepted if the quality of its ball did not get worse. In analogy, the smoothed position of a midnode will only be accepted if the quality of its shell does not get worse. For the quality measure of a quadratic element the largest difference of the Jacobian determinant at the integration points will be taken as measure. Recall that the 10-node tetrahedral element has 4 integration points. The quality of quadratic element i is now defined as:

$$Q_i^* = \left(\frac{J_{\max} - J_{\min}}{J_{\max} + J_{\min}} \right) \frac{\langle J_{\min} \rangle}{|J_{\min}|} + 10^{30} (1 - J_{\min}) \frac{\langle -J_{\min} \rangle}{|J_{\min}|}, \quad (948)$$

where $\langle x \rangle = x$ if $x > 0$ and $\langle x \rangle = 0$ if $x \leq 0$. The second term in the above equation takes precedence as soon as any Jacobian determinant in the element is negative.

smoothingmidnodes.f The smoothing of the midnodes is done in a similar way as for the vertex nodes (using the modified definition of "neighbors", "quality measure" etc).

projectmidnodes.f Also here the procedure is similar to the one for vertex nodes. Projection may lead to bad elements. A quadratic element is bad if the Jacobian determinant in at least one integration point is negative. Then, the projection is successively reduced. In that case, all edges belonging to the shell are listed as bad edges.

smoothbadmid.f In `smoothbadmid.f` the position of all subsurface bad midnodes (surface bad midnodes are not modified) is optimized by minimizing the following function F (using `fminsi`):

$$F = \max_{\substack{i \in \text{shell} \\ j \in i}} Q_j + \sum_{\substack{i \in \text{shell} \\ k \in (\text{ip})_i}} 10^{30} (1 - J_{ik}) \frac{\langle -J_{ik} \rangle}{|J_{ik}|}. \quad (949)$$

In the first term of the right hand side Q_j is the quality measure for linear tetrahedra. To this end each quadratic tetrahedral element is subdivided into 8 linear tetrahedrons. This measure seems to be more appropriate than using Q_i^* during the optimization and leads to better shaped tetrahedrons. So basically the first term optimizes the volume of the 8 linear subtetrahedra of the quadratic tetrahedron. The second term avoids the presence of negative Jacobian determinants at the integration points (abbreviated as `ip` in the above formula).

10.13.6 Modifying the boundary conditions

After refining the mesh the boundary conditions have to be moved from the old (= unrefined) mesh to the new (= refined) mesh. This includes both single point constraints (SPC's) and multiple point constraints (MPC's). The general approach is the following: the boundary conditions on the old mesh are kept and new equations are generated linking all surface nodes of the old mesh (i.e. the part which has been remeshed) to those of the new mesh. Subsurface nodes are not relevant, since boundary conditions are usually only applied to surface nodes.

So for each surface node in the old mesh three equations (in 3D) are generated linking the displacement of this node to nodes of the new mesh. The coefficients of the equations are obtained by a standard interpolation procedure. For a node "a" in the old mesh linked to nodes 30, 58, 123 and 4009 in the new mesh such an equation looks like:

$$u_a = x_1 u_{30} + x_2 u_{58} + x_3 u_{123} + x_4 u_{4009} \quad (950)$$

or

$$u_a - x_1 u_{30} - x_2 u_{58} - x_3 u_{123} - x_4 u_{4009} = 0 \quad (951)$$

for the displacement component u in x -direction. Notice that the coefficient of the dependent node (first node in the equation; belongs to the old mesh) is

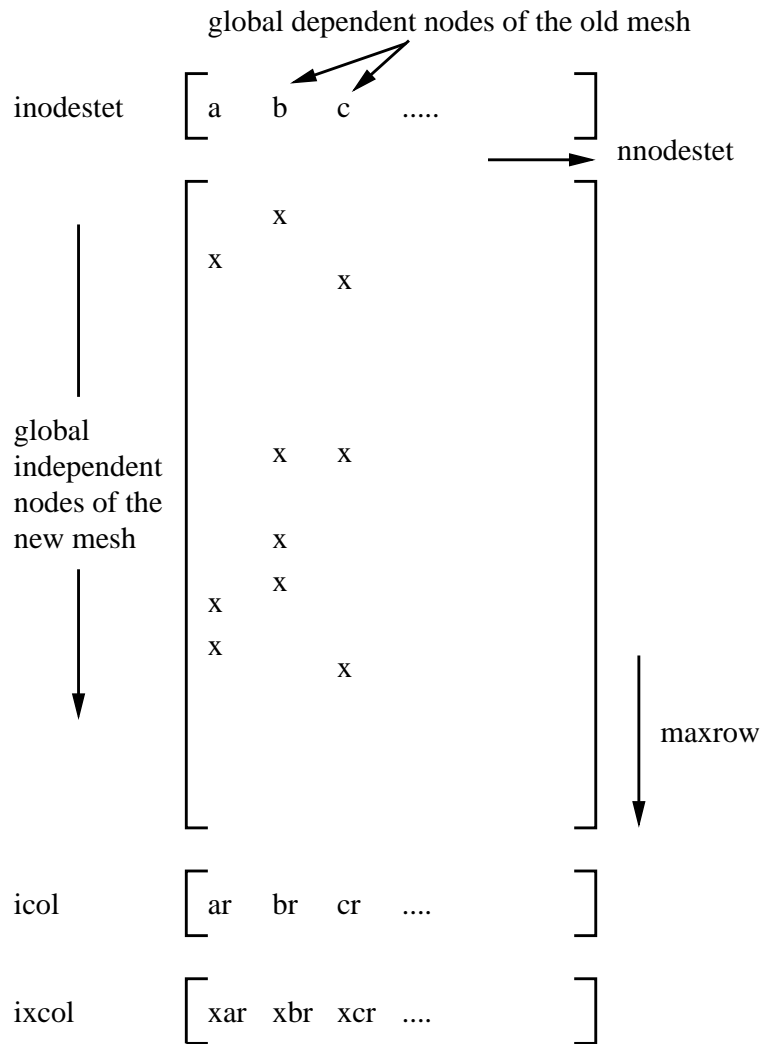

Figure 198: Matrix structure of the connecting equations

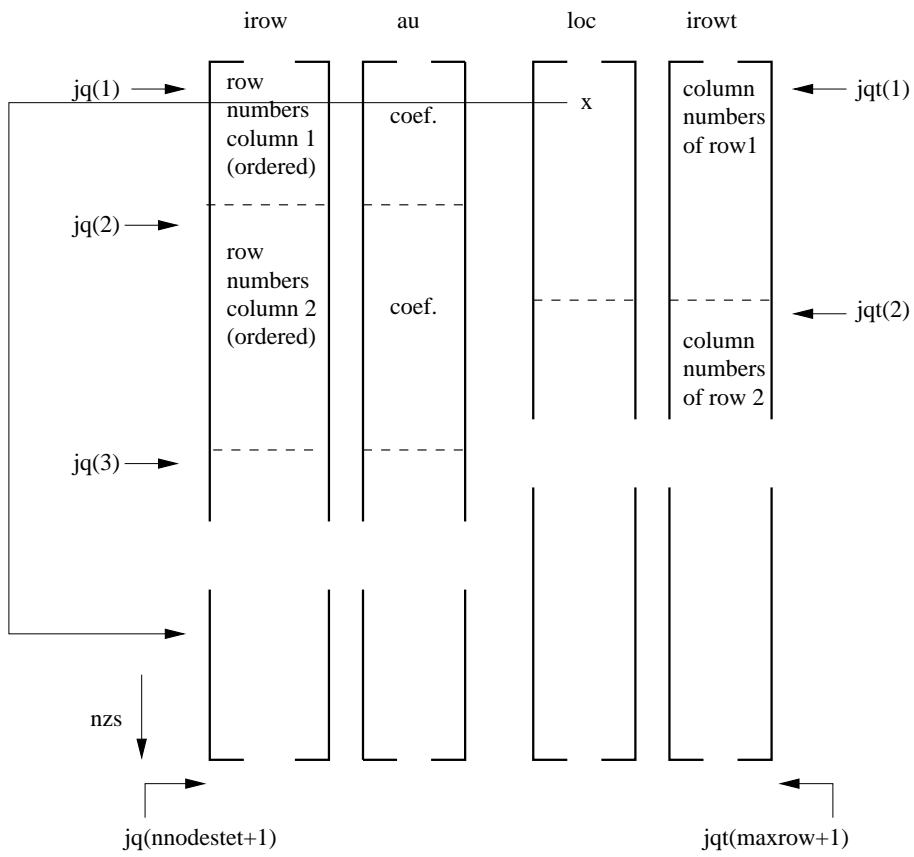

Figure 199: Fields describing the matrix structure

1, the other nodes in the equations can be considered to be independent nodes and belong to the new mesh.

These equations can be put in matrix form, with the columns corresponding to the dependent nodes (ordered in ascending order with a total of `nnodestet` nodes) and the rows corresponding to the global nodes numbers of the surface nodes of the refined mesh, Figure 198. The maximum independent node number occurring is labeled `maxrow`. Notice that, since the equations are identical for the global x-, y- and z-direction, only one equation per dependent node is stored. The matrix structure is stored with fields which are partially similar to the general way in which the stiffness matrix is stored in CalculiX, i.e. (see also Figure 199):

- `au`: stores the nonzero entries in the matrix (i.e. the “x” in Figure 198) column by column. Entries within each column are ordered corresponding to the ascending row numbers.
- `irow`: corresponds to the row number (the global number of the independent nodes in the connecting equations) of the entries in `au`.
- `icol(i)`: number of nonzero entries in column `i`
- `jq(i)`: entry in fields `au` and `irow` corresponding to the first nonzero value in column `i`. The size of the field is `nnodestet+1` in order to mark the last entry in fields `au` and `irow` (corresponds to `jq(nnodestet+1)-1`).
- `irowt`: lists the column numbers in the matrix, row by row. Contrary to field `irow` the entries within each row are not ordered.
- `jqt(i)`: entry in field `irowt` corresponding to the first nonzero value in row `i`.
- `loc`: localizes each entry in field `irowt` within field `irow` and `au`, i.e. entry `irowt(i)` corresponds with entry `irow(loc(i))` and `au(loc(i))`.
- `ixcol(i) = icol(i)*(nnodestet+1)+i`.

Figure 200 describes these fields for a simple example involving the following connecting equations:

$$u_{22} + au_6 + bu_{31} = 0 \quad (952)$$

$$u_{134} + cu_{31} + du_{59} + eu_{78} = 0 \quad (953)$$

$$u_{202} + fu_3 + gu_6 = 0 \quad (954)$$

The fields above are needed because the terms in the connecting equations have to be reordered for each SPC or MPC on the unrefined mesh. Indeed, assume that the displacement in x for node 22 above was set to zero in the

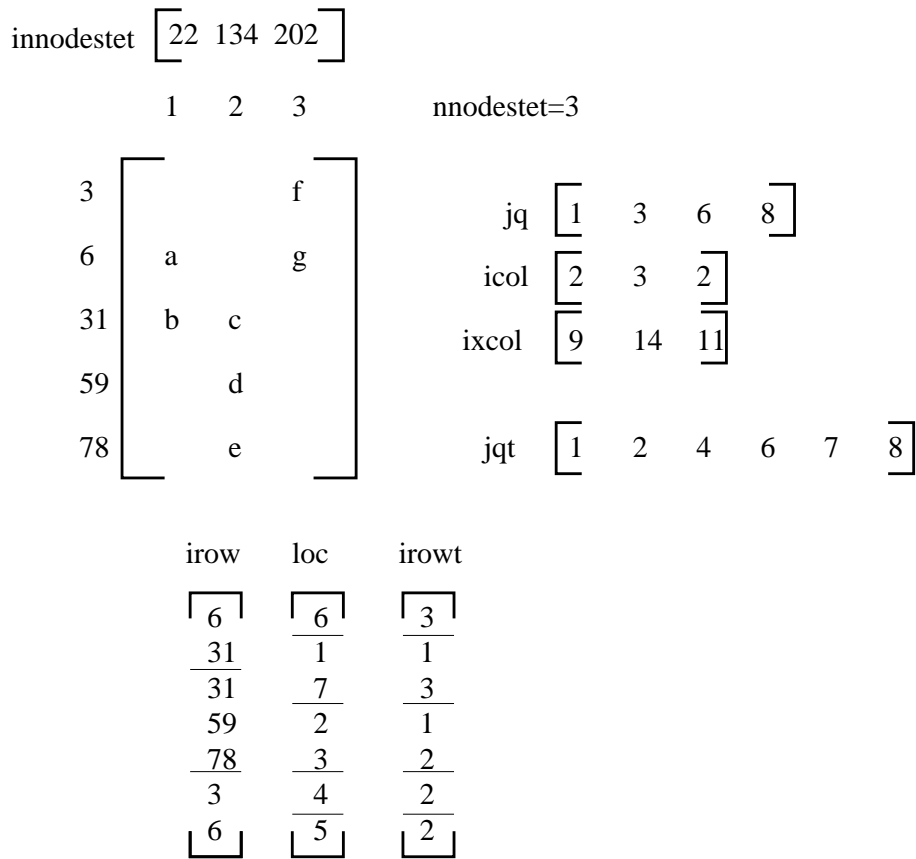

Figure 200: Example for the fields defining the connecting equations

unrefined mesh by a SPC of the form $u_{22} = 0$. Then u_{22} occurs as dependent degree of freedom in the SPC and the MPC above. This is not allowed in CalculiX: a node can occur at most once as dependent dof. Therefore, the MPC has to be reordered, e.g. in the form

$$au_6 + u_{22} + bu_{31} = 0 \quad (955)$$

making node 6 of the refined mesh the dependent dof. This reordering has to be done for each node of the unrefined mesh used in a SPC or MPC. In order not to run out of independent refined mesh nodes which can be used as dependent nodes, the equations are reordered starting from the ones with fewest terms to the ones with most terms. To that end field *icol*, which contains the number of independent terms in each equations, can be used and ordered. However, in order to keep the information to which column (i.e. unrefined mesh node) the independent count belongs, the field *ixcol* is created. Notice that this field, when ordered, keeps the same ordering as field *icol*.

Before ordering *ixcol* it is modified in such a way that all entries corresponding to unrefined mesh nodes which do not belong to SPC's or MPC's are set to zero (since they do not have to be reordered). Let us assume that in the example in Figure 200 there is a SPC defined in node 22 and 134, then *ixcol* is rewritten as $ixcol = [9140]$, which yields after reordering $ixcol = [0914]$. Then, the columns are treated from low to high in *ixcol*. The first nonzero entry is 9, which corresponds to column 1. For this column the largest coefficient (in absolute value) is identified and the corresponding term used as dependent dof. Let us assume that $|b| > |a|$, then the original equation

$$u_{22} + au_6 + bu_{31} = 0 \quad (956)$$

is reordered as

$$bu_{31} + u_{22} + au_6 = 0, \quad (957)$$

and node 31 cannot be used as dependent term in any other equation. Therefore, all row entries in row 31 have to be deactivated. This is done by reverting the sign all "31" entries in field *irow*, by use of fields *irowt*, *jqt* and *loc*. Subsequently, entry "9" in field *ixcol* is set to zero, since the corresponding column has been rearranged. Now only entry 14 is left, which corresponds to column 2 in field *au*. For the determination of the maximum coefficients only positive entries in field *irow* are taken into account, therefore, only coefficients *d* and *e* are compared. If $|d| > |e|$ then the original equation

$$u_{134} + cu_{31} + du_{59} + eu_{78} = 0 \quad (958)$$

is reordered as

$$du_{59} + u_{134} + cu_{31} + eu_{78} = 0 \quad (959)$$

and row 59 is deactivated for further equation rearrangement by switching its sign in field *irow*.

Notice that all coefficients in matrix au are nonpositive since the shape function values for a linear or quadratic triangle are nonnegative (used in the interpolation procedure). Therefore, all rearranged equations are characterized by a nonpositive coefficient of the dependent terms.

The procedure may not be fool proof (especially if a lot of SPC's or MPC's constrain the unrefined mesh). If, due to the rearrangement of other equations no independent node in an equation not treated yet remains, an error message is issued and the program stops.

The procedure just described is repeated for each step, since the SPC's and MPC's can change from step to step. Before starting the procedure, however, the equations from the last step are reordered in their original form (i.e. with a leading coefficient of 1).

10.14 Crack propagation

A cyclic crack propagation calculation consists of a series of increments. Each increment is considered to be independent of the others. The input for an increment is characterized by stresses and maybe temperatures for the uncracked structure, a triangulation of the current cracks using S3 shell elements and crack propagation material data. The following operations are performed before the first increment:

1. read the crack propagation material data
2. read and store the uncracked stress and possibly temperature results in fields `integglob` and `doubleglob`

Subsequently, in each iteration the following actions are taken:

1. catalogue the nodes belonging to the field `kontri(3,1..ntri)` where `ntri` is the total number of triangles in all cracks (`cattri.f`).
2. catalogue the edges in fields `ipoed(1..nk)`, `iedg(3,1..nedg)` and `ieled(2,1..nedg)`, where `nk` is the total number of nodes in the model and `nedg` the total number of edges belonging to S3-elements. An edge is characterized by two nodes and is catalogue according to the lowest node number of both. Entry `ipoed(n1)` points to a row `iedg(1..3,ipoed(n1))`, in which `n1=iedg(1,ipoed(n1))` is one of the nodes and `n2 = iedg(2,ipoed(n1)) > n1` is the other node. If more edges are present in the mesh for which node `n1` is the lowest node number, `iedg(3,ipoed(n1))` points to the next such entry in `iedg`, else `iedg(3,ipoed(n1))` is zero. This is similar to the structure on the left of Figure 193, except that in the present context the number of edges is not changed within an increment and the flag `ifreed` is not needed. For each edge `i` the entries `ieled(1,i)` and `ieled(2,i)` point to the triangle numbers in `kontri` to which the edge belongs. For an edge belonging to only 1 triangle entry `ieled(2,i)` is zero.

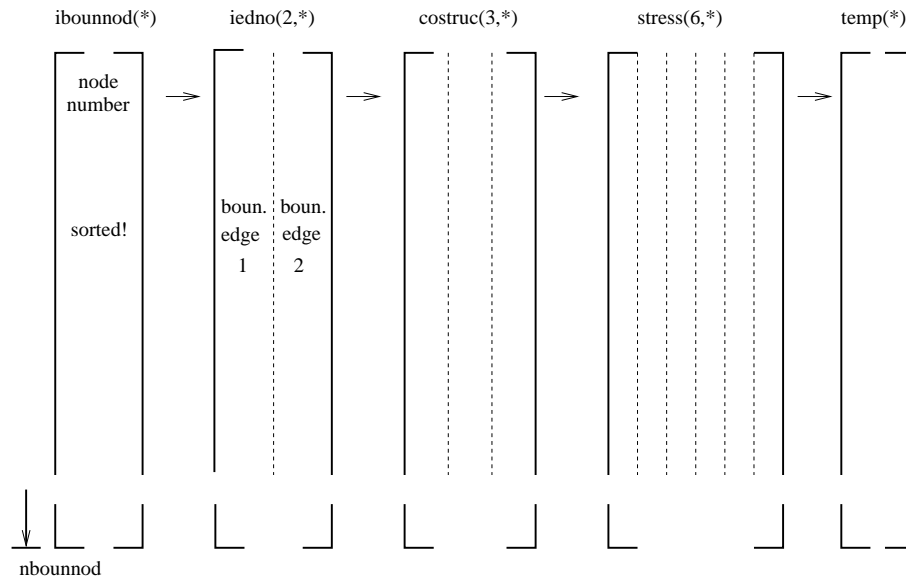

Figure 201: Fields for the boundary nodes and edges

3. determine the boundary edges and the boundary nodes. An edge is a boundary edge if it belongs to only one triangle. A node is a boundary node if it belongs to a boundary edge. The boundary nodes are stored in field `ibounnod(1..nbounnod)`, the boundary edges in `ibounnedg(1..nbounnedg)`. The field `iedno(2,1..nbounnod)` contains the boundary edge numbers to which a boundary node belongs. It is important to distinguish between the edge numbers (1...`nedg`), corresponding to the rows in field `iedg`, and the boundary edge numbers (1...`nbounnedg`), corresponding to the rows in field `ibounnedg`. The fields `ibounnod` and `ibounnedg` together with some other fields, which will be discussed soon, are shown in Figure 201. The nodes in field `ibounnod` are sorted in ascending order.
4. determine the front nodes: these are boundary nodes (i.e. on the boundary of the crack triangulations) lying inside the structure. The way this is done is by taken recourse to routines `interpolextnodes.f` and `basis.f`. The latter routine interpolates the stress and temperature from the uncracked structure onto each boundary node. In fact, `basis.f` is a very general routine doing the interpolation to whatever point characterized by its global cartesian coordinates. It looks for a location inside the master mesh which is as close as possible to the given point and assigns the fields interpolated in this location. Furthermore, it returns the interpolated values, the interpolation coefficients, the nodes of the master mesh used for the interpolation, the coordinates of the interpolation location and the distance from the given point to the interpolation location.

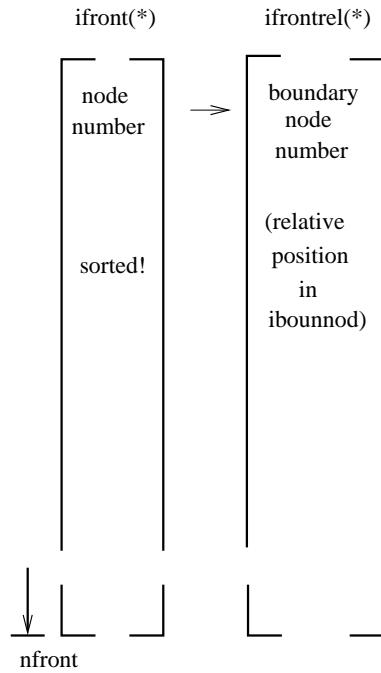

Figure 202: Fields for the front nodes (before analyzing the adjacency relations)

If this distance is really small (a cut-off of 10^{-6} is used), the boundary node is a front node, else it is not. The front nodes are stored in ascending order in field `ifront(1..nfront)`, the corresponding boundary node location (i.e. the row in field `ibounnod`) is stored in `ifrontrel(1..nfront)`, cf. Figure 202. The coordinates of the interpolation locations are stored in `costruc(3,1..nbounnod)` and the interpolated stresses and temperatures in `stress(6,1..nbounnod)` and `temp(1..nbounnod)`, cf. Figure 201.

Notice that when using the coordinates in field `costruc` one obtains a contour of the crack contracted on the structure, i.e. the boundary nodes outside the structure are projected onto the structure.

5. determine the due order of the nodes in field `ifront` by taking the adjacency relations into account (done in routine `adjacentbounodes.f`) and adding to each non-closed front a node on either side (start and end of the front) just outside the structure, Figure 203. Due to this, the value of `nfront` will have changed if not all cracks are subsurface cracks. The nodes are stored in clockwise direction when looking in the positive shell normal direction. The start and end location of each front is stored in fields `istartfront(1..nnfront)` and `iendfront(1..nnfront)`, where `nnfront` is the number of fronts. A zero in the corresponding field `isubsurffront(1..nnfront)` indicates that the front belongs to a surface crack, a one that it belongs to a

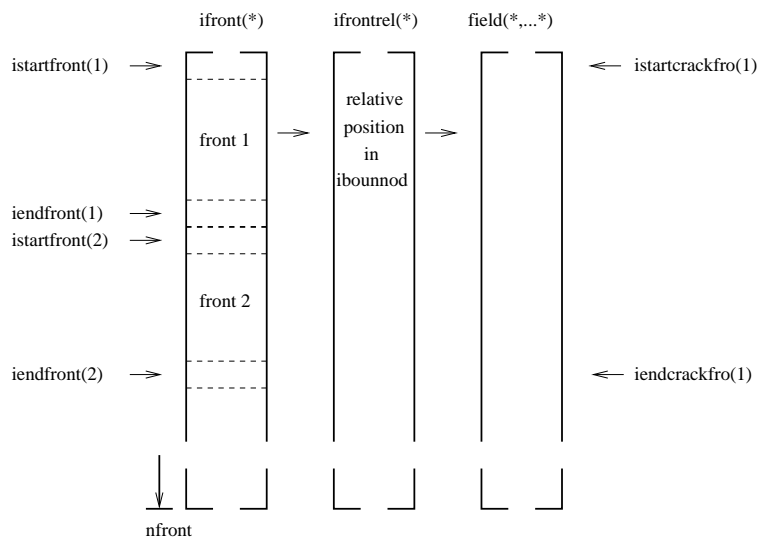

Figure 203: Fields for the front nodes (after analyzing the adjacency relations)

subsurface crack, Figure 204. The field “field” in Figure 203 is representative for a large number of fields: $xt(3,*)$, $xn(3,nstep,*)$, $xa(3,nstep,*)$, $xnplane(3,nstep,*)$, $xaplane(3,nstep,*)$, $posfront(*)$, $acrack(nstep,*)$, $xk1(nstep,*)$, $xk2(nstep,*)$, $xk3(nstep,*)$, $xkeq(nstep,*)$, $phi(nstep,*)$, $psi(nstep,*)$, $xkeqmin(*)$, $xkeqmax(*)$, $dadn(*)$, $wk1(*)$, $wk2(*)$, $wk3(*)$, $dkeq(*)$, $domstep(*)$, $domphi(*)$, $ifrontprop(*)$, which will be discussed further in this section.

The fronts are stored crack by crack. The start and end of each crack in field $ifront$ is stored in fields $istartcrackfro(1..ncrack)$ and $iendcrackfro(1..ncrack)$ (Figure 205), where $ncrack$ is the number of cracks. Figure 203 applies to a case in which the first crack consists of two fronts.

At the same time, also the node order in field $ibounnod$ is changed according to adjacency, crack by crack. Remember that this field contains all boundary nodes, no matter whether they belong to a front or not. Therefore, each crack in field $ibounnod$ is a closed contour. After changing the node order in $ibounnod$ all related fields in Figure 201 are also modified appropriately as well as the entries in field $ifrontrel$ (Figure 203), so that full consistency is guaranteed. The starting and ending position of each crack in field $ibounnod$ is stored in $istartcrackbou(1..ncrack)$ and $iendcrackbou(1..ncrack)$.

6. The cross section location of the crack front with the external boundary is reevaluated. Recall that this location was determined in `adjacentboundodes.f` as the projection of the external boundary node closest to the structure onto the surface of the structure (coordinates in `costruc`). Let

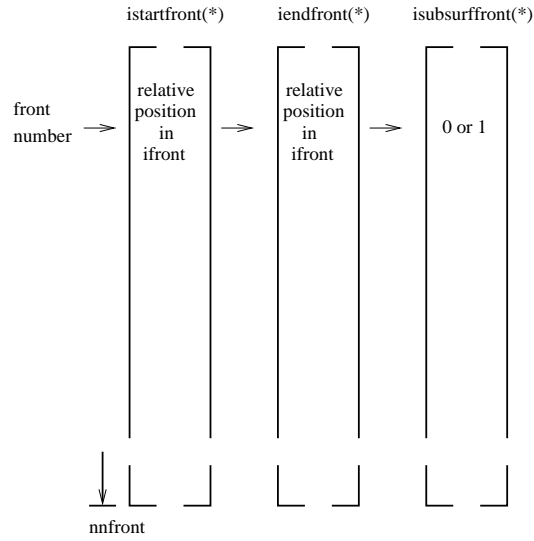

Figure 204: Fields for the front characteristics

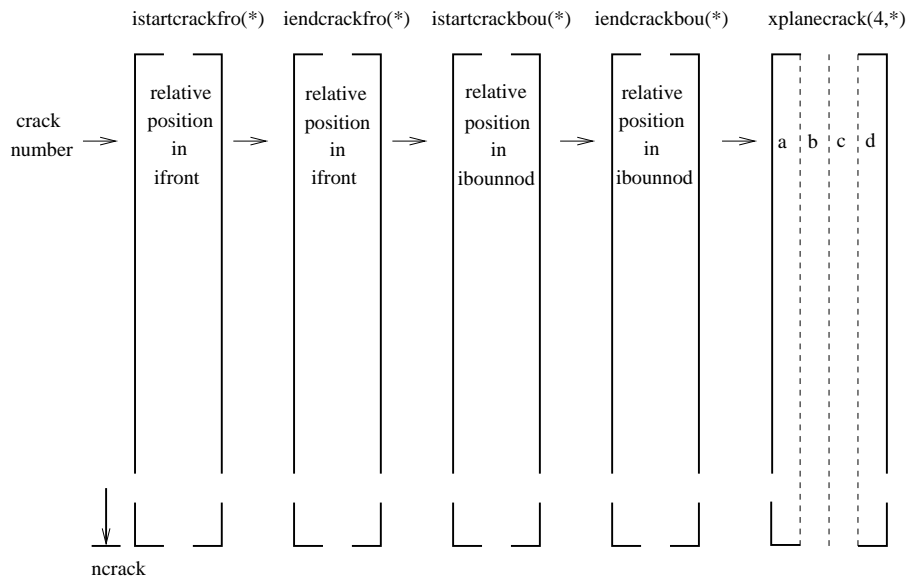

Figure 205: Fields for the crack characteristics

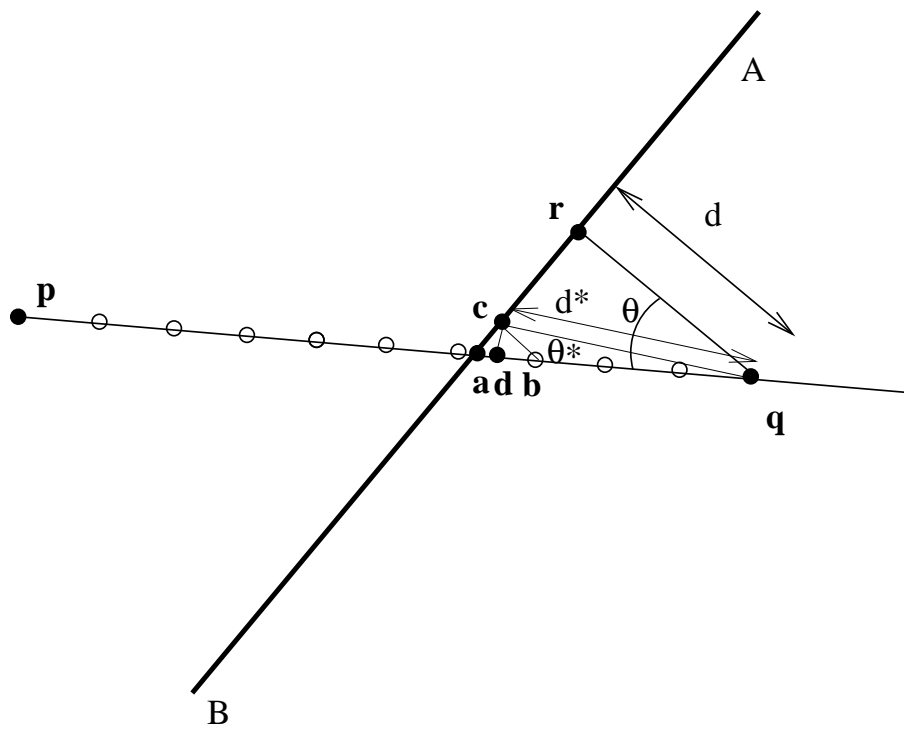

Figure 206: Calculation of a front position external but close to the free surface.

us assume that in Figure 206 the free surface is AB and nodes \mathbf{p} and \mathbf{q} are on the front, \mathbf{q} is external. \mathbf{r} is the projection of \mathbf{q} on the surface and is a first approximation of the intersection point \mathbf{a} . A better approximation for \mathbf{a} is:

$$\mathbf{a} \approx \mathbf{q} + \frac{d}{\cos \theta} \frac{\mathbf{p} - \mathbf{q}}{\|\mathbf{p} - \mathbf{q}\|}. \quad (960)$$

However, if AB is strongly curved and θ is big, this may not be a good approximation. Therefore, if θ exceeds roughly 25° \mathbf{a} is calculated more accurately. To this purpose the interval $[\mathbf{p}, \mathbf{q}]$ is divided into 10 segments and, starting from \mathbf{p} the first location is determined which is external to the structure. In the Figure this is \mathbf{b} . The projection \mathbf{c} of \mathbf{b} is now stored in `costruc` as the projection of \mathbf{q} . As starting position for the propagation increment in `crackprop.f` (see later on) point \mathbf{d} is taken satisfying the equation above with d replaced by d^* and θ by θ^* :

$$\mathbf{d} = \mathbf{q} + \frac{d^*}{\cos(\theta^*)} \frac{\mathbf{p} - \mathbf{q}}{\|\mathbf{p} - \mathbf{q}\|}, \quad (961)$$

where

$$\cos(\theta^*) = \frac{(\mathbf{c} - \mathbf{q}) \cdot (\mathbf{p} - \mathbf{q})}{\|\mathbf{c} - \mathbf{q}\| \cdot \|\mathbf{p} - \mathbf{q}\|}. \quad (962)$$

This approach has proven beneficial in guaranteeing that \mathbf{d} is lying outside the structure.

7. A local coordinate system in each node of the crack front is created and stored in fields `xt(3,nfront)`, `xn(3,nfront)` and `xa(3,nfront)`. This is done in routine `createlocalsys.f`. It consists of:
 - A local normalized tangent \mathbf{t}_i (field `xt`) to the crack front (i is the nodal position).
 - a normal vector \mathbf{n}_i obtained by taking the mean of the normal vectors on the shell elements to which the front node belongs, projecting this mean vector onto a plane orthogonal to the local tangent and normalizing. Notice that this normal vector is pointing in the positive direction of the shell elements (field `xn`).
 - a normalized vector in propagation direction $\mathbf{a}_i = \mathbf{t}_i \times \mathbf{n}_i$ (field `xa`).
8. Subsequently, the crack length is calculated in subroutine `cracklength.f`. In Section 6.9.27 the two different ways of calculating the crack length are explained: CUMULATIVE and INTERSECTION.
 - The method CUMULATIVE is trivial to code

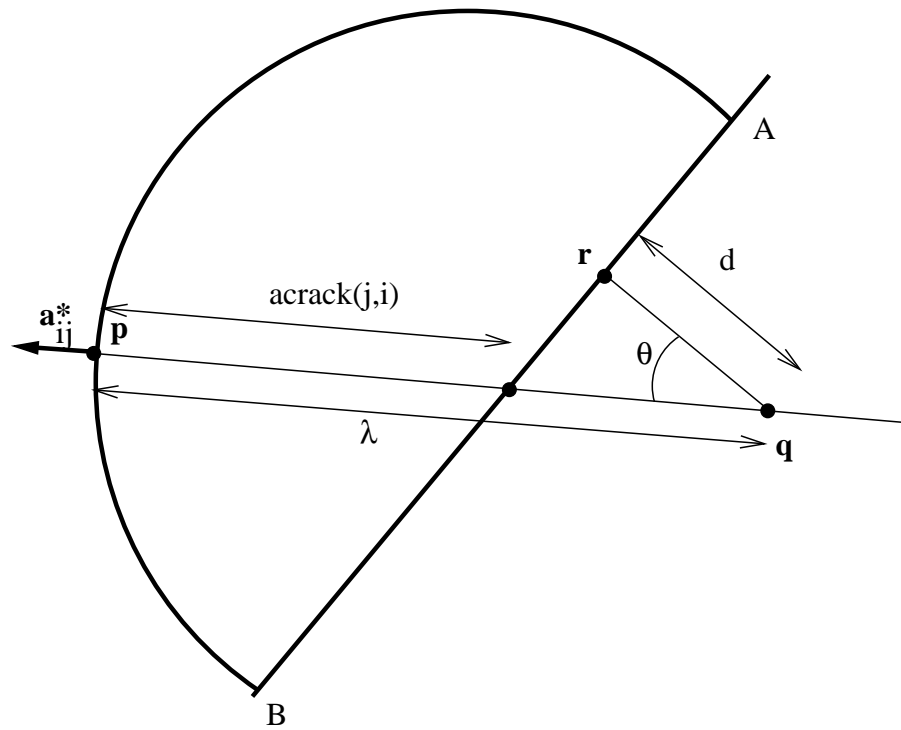

Figure 207: Calculation of the distance of a front node from the intersection of a straight line mit unit vector \mathbf{a}^* with the free surface

- The method INTERSECTION creates in each front node by means of the tangential vector a plane locally orthogonal to this vector and checks what other edge (but not immediately adjacent) along the closed crack front is cut by this plane (using fields such as iboundeg). An edge is cut by a plane if the substitution of the coordinates of its nodes into the plane equation yields results with a different sign.

The crack length is stored in field `acrack(nfront)`. In addition, for each front node the relative position along the front, taking a value between 0 and 1, is also calculated in `cracklength.f` and stored in field `posfront(nfront)`.

9. The crack length is smoothed and shape factors are determined in routines `cracklength_smoothing.f` and `crack_shape.f`, respectively. The procedures are described in Section 6.9.27. For the shape factors a field `shape(3,nfront)` is created, allowing for different shape factors according to the mode. Routine `shape.f` is conceived as a user subroutine, so the user can easily code his/her own shape factors.
10. The stress intensity factors for mode I, mode II and mode III are calculated in `stressintensity.f` and stored in fields `xk1(nstep,nfront)`, `xk2(nstep,nfront)`

and `xk3(nstep,nfront)`. The equivalent stress intensity factor, the deflection angle and twist angle are stored in `xkeq(nstep,nfront)`, `phi(nstep,nfront)` and `psi(nstep,nfront)`. Subsequently, the equivalent K-factor and the deflection angle is smoothed in `stressintensity_smoothing.f`. The target crack increment length is determined in `calcdatarget.f`. For details the reader is again referred to Section 6.9.27.

11. The crack propagation rate is calculated in routine `crackrate.f`. Again, this routine is conceived as a user subroutine. Right now, a rather simple algorithm is implemented using the maximum equivalent K-factor for the complete mission at a given location along the crack front. More sophisticated procedures are conceivable using cycle extraction such as in [82]. Output of this routine includes the crack propagation increment `da(nfront)`, the crack propagation rate `dadn(nfront)`, the worst K_I , K_{II} and K_{III} factors `wk1(nfront)`, `wk2(nfront)` and `wk3(nfront)`, the largest and smallest equivalent K-factor in the mission `xkeqmin(nfront)` and `xkeqmax(nfront)`, the equivalent stress intensity range of the main cycle `dkeq(nfront)`, the dominant step `dompstep(nfront)` and the dominant deflection angle `domphi(nfront)`. The number of cycles in this increment is calculated based on the target crack increment and the maximum crack propagation rate anywhere along a crack front.
12. In `crackprop.f` the position of the propagated node is calculated for each front node. The propagation is in the direction of \mathbf{a} . At a free boundary the new crack front has to cut the free surface, therefore at least the first and last node on a front have to lie outside the structure. This is checked by the interpolation routine `basis.f`. If e.g. the first node is inside the structure, the line segment connecting the node with its propagated position is rotated in steps of 5° until the propagated node lies outside the structure. In order for this procedure to work under all circumstances a minimum crack propagation increment of 1.2×10^{-6} [L] is defined.

Notice that for this procedure to work properly, the first and last node of the actual front have to lie on the intersection of the front with the free surface. This is not necessarily guaranteed by using the field `costruc`. Indeed, the values in `costruc` are determined in routine `basis.f`. If a node is inside the structure, `costruc` contains its actual coordinates, if it is outside the structure, it contains the coordinates of its projection onto the free surface. If the front makes an angle with the free surface which is significantly different from 90° , the projection will not lie on the front. Therefore, for the end nodes a correction is made similar to Figure 207: assuming $\mathbf{p} - \mathbf{q}$ is the crack front, the projected position \mathbf{r} is replaced by $\mathbf{p} + \text{acrack}(i)(\mathbf{q} - \mathbf{p})/\|\mathbf{q} - \mathbf{p}\|$.

The propagated node numbers are stored in `ifrontprop(nfront)`.

13. Subsequently, on the new crack front consisting of the propagated nodes nodes are inserted or existing nodes are removed in order to establish a

distance between the propagated nodes approaching the mean distance between any two nodes on the initial front. This latter quantity is stored in `charlen(1..nnfront)`. The detailed approach is as follows: between any propagated nodes n_1 and n_2 the distance is calculated, divided by the targeted distance, and mathematically rounded to the nearest integer. If this integer is zero, node n_2 is removed and the calculation is repeated for n_1 and the node next to n_2 . If this integer is one, n_2 is kept and is considered to be a new node (with a new node number). If it exceeds one, let's say it is n , $n - 1$ equidistant nodes are inserted in between n_1 and n_2 . These nodes are together with n_2 the new nodes. All new nodes are stored in fields `ifronteq(1..nfronteq)`, `istartfronteq(1..nnfront)` and `iendfronteq(1..nnfront)`, which are completely analogous to `ifront`, `istartfront` and `iendfront`.

14. Finally, the mesh describing the crack is extended by the new increment. To this end new elements are generated connecting the nodes on the actual front i_1, i_2, \dots, i_p with the propagated equidistance nodes j_1, j_2, \dots, j_q . First, for each node j_k the node among the actual nodes i_1, i_2, \dots is looked for which is the closest neighbor (using routine `near3d.f`). Let us call this node n_k . Then, the algorithm for the triangulation is as follows:

- set $a = b = 1$
- start loop
- create a triangle i_a, j_b and j_{b+1} .
- If $n_b \neq n_{b+1}$, then let's say that $n_b = i_c$ (c naturally exists, since n_b belongs to the actual front). Then, create triangle i_c, i_{c+1}, j_{b+1} , triangle $i_{c+1}, i_{c+2}, j_{b+1}$.. until triangle $i_{c+n-1}, i_{c+n}, j_{b+1}$ where $i_{c+n} = n_{b+1}$. Set a to $c + n$.
- if i_p and j_q both belong to the last created triangle, exit.
- set $b + 1$ to b .
- cycle loop

Notice that shell elements are expanded in `CalculiX`. Therefore, at the start of routine `crackpropagation.c` the crack surfaces are really modeled by 6-node wedge elements. Therefore, the extension of the crack is also modeled by wedges with a very small thickness.

15. store the incremental results into global fields (`wk1glob,...`)

16. start a new increment

After all increments have been calculated (or if nowhere along the crack front propagation occurred or if K_c was exceeded anywhere along the crack fronts) the results are stored in `frd-format`.

10.15 Interpolation procedure

Interpolation in between an existing mesh is used in different places in CalculiX:

- Mesh refinement
 - Determine the desired edge length in newly created nodes (newnodes.f, updategeodata.f)
 - Determine the interpolation coefficients for the connection of a node in the unrefined mesh to the refined mesh (treatment of SPC's and MPC's: genmpc.f)
 - Determine the interpolation coefficients for the connection of a node in the refined mesh to the unrefined mesh (treatment of temperatures: genratio.f)
- Crack propagation calculations
 - For the crack length definition: find the intersection of a straight line of the external surface of the structure (cracklength.f)
 - For the crack propagation: find the intersection of the crack front with the external surface of the structure (crackprop.f)
 - Determine the nodes on the crack boundary which are inside the structure (interpolextnodes.f)
- Submodel calculations
 - Interpolation of displacements, stresses... onto the boundary of the submodel (interpolsubmodel.f)

The input to the interpolation procedure is a master mesh consisting of volumetric elements (no 1d-elements such as beams or 2d-elements such as shells) and results at the nodes of the mesh, and a slave “mesh” consisting of one or more nodes in which the results are to be interpolated. Notice that the slave mesh does not have to contain elements. The interpolation consists of the following steps:

- Tetrangulation of the master mesh using linear tetrahedral elements. Calculation of the centers of gravity of these tetrahedrons and sorting these in global x-direction, global y-direction and global z-direction.
- For each slave location:
 - find the set of the n=1 closest centers of gravity (the corresponding set of tetrahedra is called the n-closest-set)
 - Check whether the slave location belongs to any of the tetrahedrons in the n-closest-set. If yes, take this tetrahedron for further analysis; if not, identify the tetrahedron in the n-closest-set to which the slave location is closest.

- Check whether the slave location belongs to the master element to which the tetrahedron belongs. If yes, interpolation is done within this master element; if not, check the master elements of all other tetrahedra in the n -closest-set. If this test is positive, perform interpolation in the identified master element. If negative, save the closest position to any of the master elements considered and repeat the exercise for this slave location for $n=10$ and $n=100$. If the latter is not successful, the slave location is considered to be outside the master mesh and the closest projection is saved.

In the next sections the different aspects of the procedure are analyzed in detail.

10.15.1 Tetrangulation of the master mesh

The master mesh must consist of volumetric elements, i.e. linear or quadratic hexahedra, wedges or tetrahedra. For each element type a remeshing into linear tetrahedral elements was devised: a C3D8, C3D6, C3D20(R), C3D15 and C3D10 element is mesh with 6 (field i1 in `getuncrackedresults.c`), 3 (field i2), 22 (field i4), 14 (field i5) and 8 (field i6) linear tetrahedra, respectively. Subsequently, the centers of gravity of the resulting tetrahedra are calculated and sorted according to the global x -values, the global y -values and global z -values. Furthermore, the element numbers of the original parent elements of these tetrahedra (several tetrahedra share one parent element) are stored in fields `elemnr` (original element numbers; may exhibit gaps) and `iparent` (continuous increasing numbers starting at 1). All values are frequently stored in fields `integrglob` and `doubleglob` for further use at the time of interpolation.

10.15.2 Nearest point algorithm

The centers of gravity of the linear tetrahedra form a cloud of points. One of the key parts of the algorithm is the fast selection of the n closest points to a given new location in which interpolation is requested. The procedure is illustrated in two dimensions in Figure 208.

The point on the cross section of the two global axes p is the point in which the interpolation is to be performed. The black circles symbolize the point cloud. Assume we would like to know the closest 3 points. The points in the cloud are available in two sorted arrays, one sorted in the global x -direction and one in the global y -direction. First, the location of the point p in these two arrays is determined using the routine `ident.f`. Then, a rectangle is expanded about p reaching in each direction east, north, west and south until the next point in the cloud is attained. This is symbolized with the simple dashed lines and the points are denoted A, B, C and D (A and D coincide). Then, the distance from p to these points is calculated, sorted, and stored in an array. The size of this array is the number of closest neighbors requested, so in our case only the smallest three distances are kept.

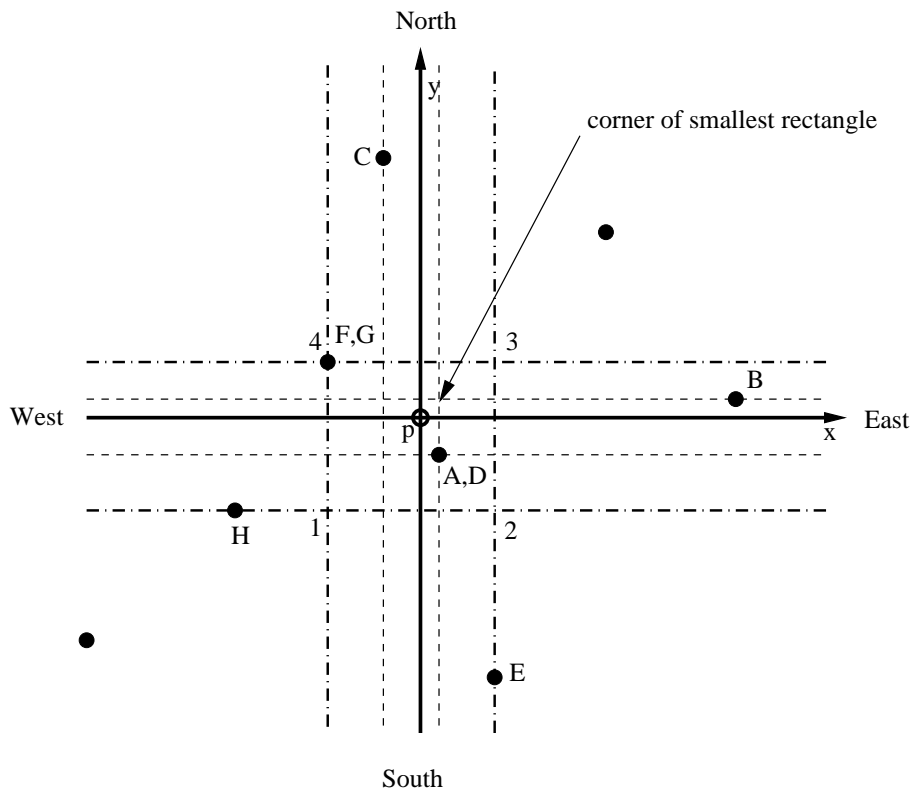

Figure 208: Scheme of the nearest point algorithm

Next, the rectangle is expanded in each direction until the next cloud point is reached, denoted by E, F, G and H. Again, the distance from p to these points is calculated, stored in the distance array, sorted and the lowest three values are kept (only the three closest points are needed). Now, this procedure is repeated until the smallest distance from p to one of the corner points of the rectangle (symbolized by 1, 2, 3 and 4 for the largest rectangle shown in the figure) exceeds the largest value in the distance array. Then we know that we have found the closest three neighboring points.

The procedure in three dimensions is completely equivalent, we just have two extra directions “backward” and “forward”.

10.15.3 Tetrahedron containment

The next important algorithm is the check whether the interpolation location belongs to a given tetrahedron or not. A tetrahedron has 4 faces. These faces are catalogued according to the lowest node number in the face in fields such as `ipofa(*)` and `ifac(1..4,*)`, cf. the section 10.13.3 on face fields in mesh refinement. Each face has a unique number and is also described by a plane equation, the 4 coefficients of which are stored in `planfa(4,*)`. Now, a face belongs to at most 2 elements, and is listed in the face list `ifatet(1..4,*)` of these elements. In order to be able to distinguish between inside and outside of a tetrahedron `i` related to one of its faces, the face in `ifatet(1..4,i)` gets the sign of the plane equation of the face after substitution of the remaining node of element `i` opposite the face.

For instance, suppose face A (consisting of nodes 10, 20 and 30) belongs to element `i` (consisting of nodes 10, 20, 30 and 40). Let us assume that `ifatet(2,i)=A` and that the equation of face A is $ax + by + cz + d = 0$. Now, `ifatet(2,i)` is replaced by $A \cdot \text{sign}(ax_{40} + by_{40} + cz_{40} + d)$. Therefore, an interpolation location `p` will be on the same side of face A w.r.t. element `i` if $\text{sign}(ax_p + by_p + cz_p + d) = \text{sign}(\text{ifatet}(2,i))$. The same applies to the other faces of element `i`.

10.15.4 Finite element containment

Another vital routine is the check whether the interpolation routine belongs to an element. Contrary to linear tetrahedrons elements may have curved borders, therefore this check is more elaborate. The principal in two dimensions is shown in Figure 209.

The figure shows a quadratic quadrilateral plane face in global space (left) and local space (upper right). In local space the element is a square with side length 2. Now, the routine at stake looks for the location within the element which minimizes the distance from the interpolation location. If this distance is zero or small enough, the interpolation location belongs to the element. In order to do so a regular grid, e.g. with side length 0.1, is drawn about the origin in the local coordinate system. The distance from the interpolation location to the 8 locations on the grid around the origin (black filled circles in the figure) and the origin itself is calculated and evaluated (using the shape functions of

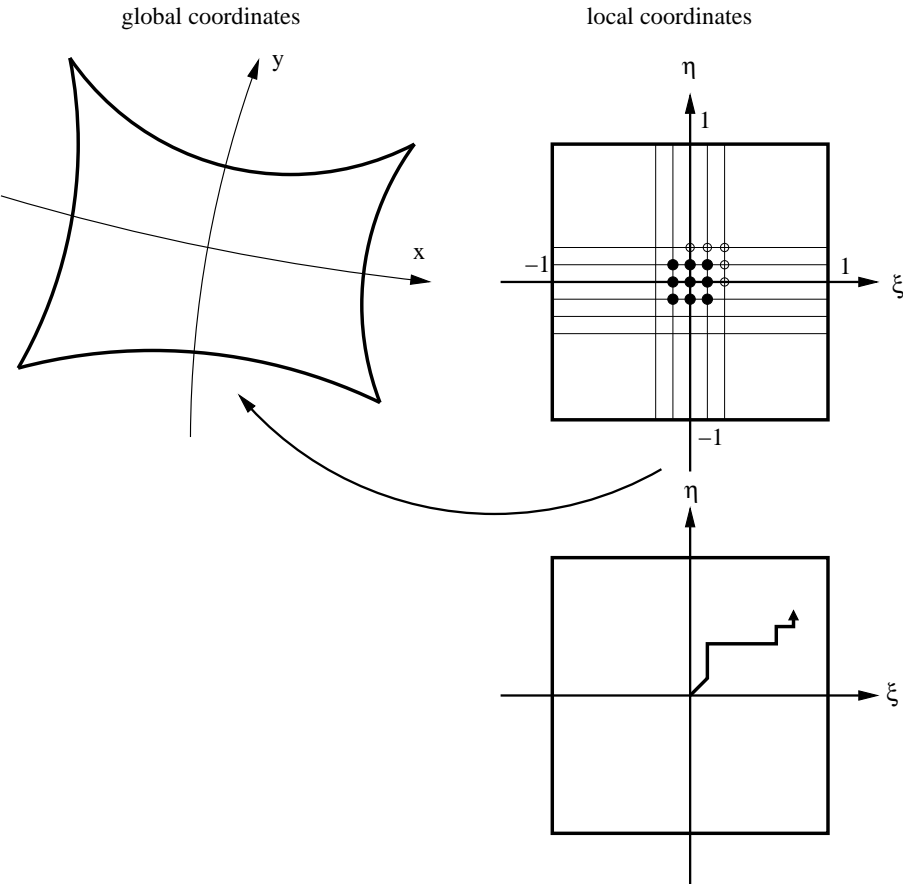

Figure 209: Closest location in an element

the element): if the distance is smallest in the origin, a local minimum is found and the next finer level grid is used. If not, e.g. if the minimum is the upper right corner, a new grid of 9 locations is drawn about this minimum location (consisting partially of existing black filled circles and new black unfilled circles) and the procedure is repeated, until a local minimum is found, i.e. the distance is smallest at the center of the square grid of 9 locations. The path may for instance look is in the lower right part of the figure.

At the local minimum a new grid is created with a grid size of one tenth of the previous grid (e.g. 0.01) and the procedure is repeated till a refined position of the minimum is found. Then again the grid size is refined and so on, usually up to a grid size of 10^{-8} in local coordinates. The resulting minimum is calculated and the distance from the interpolation position. The relevant routines are `attach_2d.f` and `attach_3d.f`.

10.16 List of variables and their meaning

Table 25: Variables in CalculiX.

variable	meaning
FILE NAMES (132 characters long)	
jobnamec(1)	jobname
jobnamec(2)	INPUT file on *VIEWFACTOR card
jobnamec(3)	OUTPUT file on *VIEWFACTOR card
jobnamec(4)	INPUT file on *SUBMODEL card (global model) or on *CRACK PROPAGATION card
jobnamec(5)	FILENAME on *SUBSTRUCTURE MATRIX OUTPUT card (storage file for stiffness matrix)
jobnamec(6)	FILE on *TEMPERATURE card
REARRANGEMENT OF THE ORDER IN THE INPUT DECK	
ifreeinp	next blank line in field inp
ipoinp(1,i)	index of the first column in field inp containing information on a block of lines in the input deck corresponding to fun- damental key i; a fundamental key is a key for which the order in the input file matters (the fundamental keys are listed in file keystart.f)
ipoinp(2,i)	index of the last column in field inp containing informa- tion on a block of lines in the input deck corresponding to fundamental key i;
inp	a column i in field inp (i.e. inp(1..3,i)) corresponds to a uninterrupted block of lines assigned to one and the same fundamental key in the input deck. inp(1,i) is its first line in the input deck, inp(2,i) its last line and inp(3,i) the next column in inp corresponding to the same fundamental key; it takes the value 0 if none other exists.
MATERIAL DESCRIPTION	
nmat	# materials
matname(i)	name of material i
no *ELECTRO- MAGNETICS calculation	
nelcon(1,i)	# (hyper)elastic constants for material i (negative kode for nonlinear elastic constants)
nelcon(2,i)	# temperature data points for the elastic constants of ma- terial i
elcon(0,j,i)	temperature at (hyper)elastic temperature point j of mate- rial i
elcon(k,j,i)	(hyper)elastic constant k at elastic temperature point j of material i
*ELECTROMAGNETICS calculation	

Table 25: (continued)

variable	meaning
nelcon(1,i)	# magnetic permeability constants for material i (always two)
nelcon(2,i)	# temperature data points for the magnetic permeability constants of material i
elcon(0,j,i)	temperature at magnetic permeability temperature point j of material i
elcon(1,j,i)	magnetic permeability at magnetic permeability temperature point j of material i
elcon(2,j,i)	domain of material i
general	
nrhcon(i)	# temperature data points for the density of material i
rhcon(0,j,i)	temperature at density temperature point j of material i
rhcon(1,j,i)	density at the density temperature point j of material i
nshcon(i)	# temperature data points for the specific heat of material i
shcon(0,j,i)	temperature at temperature point j of material i
shcon(1,j,i)	specific heat at constant pressure at the temperature point j of material i
shcon(2,j,i)	dynamic viscosity at the temperature point j of material i
shcon(3,1,i)	specific gas constant of material i
no *ELECTRO-MAGNETICS calculation	
nalcon(1,i)	# of expansion constants for material i
nalcon(2,i)	# of temperature data points for the expansion coefficients of material i
alcon(0,j,i)	temperature at expansion temperature point j of material i
alcon(k,j,i)	expansion coefficient k at expansion temperature point j of material i
*ELECTROMAGNETICS calculation	
nalcon(1,i)	# of electrical conductivity constants for material i (always 1)
nalcon(2,i)	# of temperature data points for the electrical conductivity constants of material i
alcon(0,j,i)	temperature at electrical conductivity temperature point j of material i
alcon(1,j,i)	electrical conductivity coefficient at electrical conductivity temperature point j of material i
general	
ncocon(1,i)	# of conductivity constants for material i
ncocon(2,i)	# of temperature data points for the conductivity coefficients of material i

Table 25: (continued)

variable	meaning
cocon(0,j,i)	temperature at conductivity temperature point j of material i
cocon(k,j,i)	conductivity coefficient k at conductivity temperature point j of material i
orname(i)	name of orientation i
orab(1..6,i)	coordinates of points a and b defining the new orientation
orab(7,i)	-1: cylindrical local system 1: rectangular local system
norien	# orientations
isotropic hardening	
nplicon(0,i)	# temperature data points for the isotropic hardening curve of material i
nplicon(j,i)	# of stress - plastic strain data points at temperature j for material i
plicon(0,j,i)	temperature data point j of material i
plicon(2*k-1,j,i)	stress corresponding to stress-plastic strain data point k at temperature data point j of material i
plicon(2*k-1,j,i)	for springs: force corresponding to force-displacement data point k at temperature data point j of material i
plicon(2*k-1,j,i)	for penalty contact: pressure corresponding to pressure-overclosure data point k at temperature data point j of material i
plicon(2*k,j,i)	plastic strain corresponding to stress-plastic strain data point k at temperature data point j of material i for springs: displacement corresponding to force-displacement data point k at temperature data point j of material i for penalty contact: overclosure corresponding to pressure-overclosure data point k at temperature data point j of material i
kinematic hardening	
npkcon(0,i)	# temperature data points for the kinematic hardening curve of material i
npkcon(j,i)	# of stress - plastic strain data points at temperature j for material i
plkcon(0,j,i)	temperature data point j of material i
plkcon(2*k-1,j,i)	stress corresponding to stress-plastic strain data point k at temperature data point j of material i for penalty contact: conductance corresponding to conductance-pressure data point k at temperature data point j of material i

Table 25: (continued)

variable	meaning
plkcon(2*k,j,i)	plastic strain corresponding to stress-plastic strain data point k at temperature data point j of material i for penalty contact: pressure corresponding to conductance-pressure data point k at temperature data point j of material i
kode=-1	Arrudy-Boyce
-2	Mooney-Rivlin
-3	Neo-Hooke
-4	Ogden (N=1)
-5	Ogden (N=2)
-6	Ogden (N=3)
-7	Polynomial (N=1)
-8	Polynomial (N=2)
-9	Polynomial (N=3)
-10	Reduced Polynomial (N=1)
-11	Reduced Polynomial (N=2)
-12	Reduced Polynomial (N=3)
-13	Van der Waals (not implemented yet)
-14	Yeoh
-15	Hyperfoam (N=1)
-16	Hyperfoam (N=2)
-17	Hyperfoam (N=3)
-50	deformation plasticity
-51	incremental plasticity (no viscosity)
-52	viscoplasticity
< -100	user material routine with -kode-100 user defined constants with keyword *USER MATERIAL
PROCEDURE DESCRIPTION	
iperturb(1)	= -1 : linear iteration in a nonlinear calculation = 0 : linear = 1 : second order theory for frequency/buckling/Green calculations following a static step (PERTURBATION selected) ≥ 2 : Newton-Raphson iterative procedure is active = 3 : nonlinear material (linear or nonlinear geometric and/or heat transfer)
iperturb(2)	0 : linear geometric (NLGEOM not selected) 1 : nonlinear geometric (NLGEOM selected)
nmethod	1 : static (linear or nonlinear) 2 : frequency(linear) 3 : buckling (linear) 4 : dynamic (linear or nonlinear) 5 : steady state dynamics

Table 25: (continued)

variable	meaning
irstrt(1)	6 : Coriolis frequency calculation 7 : flutter frequency calculation 8 : magnetostatics 9 : magnetodynamics (inductive heating) 10 : electromagnetic eigenvalue problems 11 : superelement creation 12 : sensitivity analysis 0: no restart calculation -1: RESTART,READ active; overwritten by write frequency while reading the restart file n>0: write frequency; either read from a restart file with RESTART,READ or specified explicitly on a RESTART,WRITE card.
irstrt(2)	0: no OVERLAY while writing a restart file 1: OVERLAY while writing a restart file
iout	governs the output and the calculation of the solution in results.c -2: v is assumed to be known and is used to calculate strains, stresses..., no result output; corresponds to iout=-1 with in addition the calculation of the internal energy density -1: v is assumed to be known and is used to calculate strains, stresses..., no result output; is used to take changes in SPC's and MPC's at the start of a new increment or iteration into account 0: v is calculated from the system solution and strains, stresses.. are calculated, no result output 1: v is calculated from the system solution and strains,stresses.. are calculated, requested results output 2: v is assumed to be known and is used to calculate strains, stresses..., requested results output
GEOMETRY DESCRIPTION	
nk co(i,j) inotr(1,j) inotr(2,j)	highest node number coordinate i of node j transformation number applicable in node j a SPC in a node j in which a transformation applies corresponds to a MPC. inotr(2,j) contains the number of a new node generated for the inhomogeneous part of the MPC
TOPOLOGY DESCRIPTION	
ne mi(1)	highest element number max # of integration points per element (max over all elements)

Table 25: (continued)

variable	meaning
mi(2)	max degree of freedom per node (max over all nodes) in fields like v(0:mi(2))...
	if 0: only temperature DOF
	if 3: temperature + displacements
	if 4: temperature + displacements/velocities + pressure
kon(i)	field containing the connectivity lists of the elements in successive order
	for 1d and 2d elements (no composites) the 3d-expansion is stored first, followed by the topology of the original 1d or 2d element, for a shell composite this is followed by the topology of the expansion of each layer
For element i	
ipkon(i)	(location in kon of the first node in the element connectivity list of element i)-1; for expanded elements the expanded connectivity comes first followed by the original 1d/2d connectivity
lakon(i)	element label C3D4: linear tetrahedral element (F3D4 for 3D-fluids) C3D6: linear wedge element (F3D6 for 3D-fluids) C3D6 E: expanded plane strain 3-node element = CPE3 C3D6 S: expanded plane stress 3-node element = CPS3 C3D6 A: expanded axisymmetric 3-node element = CAX3 C3D6 L: expanded 3-node shell element = S3 C3D8: linear hexahedral element (F3D8 for 3D-fluids) C3D8I: linear hexahedral element with incompatible modes C3D8 E: expanded plane strain 4-node element = CPE4 C3D8 S: expanded plane stress 4-node element = CPS4 C3D8 A: expanded axisymmetric 4-node element = CAX4 C3D8I L: expanded 4-node shell element = S4 C3D8I B: expanded 2-node beam element = B31 C3D8R: linear hexahedral element with reduced integration C3D8R E: expanded plane strain 4-node element with reduced integration = CPE4R C3D8R S: expanded plane stress 4-node element with reduced integration = CPS4R C3D8R A: expanded axisymmetric 4-node element with reduced integration = CAX4R C3D8R L: expanded 4-node shell element with reduced integration = S4R C3D8R B: expanded 2-node beam element with reduced integration = B31R C3D10: quadratic tetrahedral element C3D15: quadratic wedge element

Table 25: (continued)

variable	meaning
	C3D15 E: expanded plane strain 6-node element = CPE6 C3D15 S: expanded plane stress 6-node element = CPS6 C3D15 A: expanded axisymmetric 6-node element = CAX6 C3D15 L: expanded 6-node shell element = S6 C3D15 LC: expanded composite 6-node shell element = S6 C3D20: quadratic hexahedral element C3D20 E: expanded plane strain 8-node element = CPE8 C3D20 S: expanded plane stress 8-node element = CPS8 C3D20 A: expanded axisymmetric 8-node element = CAX8 C3D20 L: expanded 8-node shell element = S8 C3D20 B: expanded 3-node beam element = B32 C3D20R: quadratic hexahedral element with reduced integration C3D20RE: expanded plane strain 8-node element with reduced integration = CPE8R C3D20RS: expanded plane stress 8-node element with reduced integration = CPS8R C3D20RA: expanded axisymmetric 8-node element with reduced integration = CAX8R C3D20RL: expanded 8-node shell element with reduced integration = S8R C3D20RLC: expanded composite 8-node shell element with reduced integration = S8R C3D20RB: expanded 3-node beam element with reduced integration = B32R GAPUNI: 2-node gap element ESPRNGA1 : 2-node spring element EDSHPTA1 : 2-node dashpot element ESPRNGC3 : 4-node contact spring element ESPRNGC4 : 5-node contact spring element ESPRNGC6 : 7-node contact spring element ESPRNGC8 : 9-node contact spring element ESPRNGC9 : 10-node contact spring element ESPRNGF3 : 4-node advection spring element ESPRNGF4 : 5-node advection spring element ESPRNGF6 : 7-node advection spring element ESPRNGF8 : 9-node advection spring element network elements (D-type):] DATR : absolute to relative DCARBS : carbon seal DCARBSGE : carbon seal GE (proprietary) DCHAR : characteristic DGAPFA : gas pipe Fanno adiabatic

Table 25: (continued)

variable	meaning
	DGAPFAA : gas pipe Fanno adiabatic Albers (proprietary)
	DGAPFAF : gas pipe Fanno adiabatic Friedel (proprietary)
	DGAPFI : gas pipe Fanno isothermal
	DGAPFIA : gas pipe Fanno isothermal Albers (proprietary)
	DGAPFIF : gas pipe Fanno isothermal Friedel (proprietary)
	DLABD : labyrinth dummy (proprietary)
	DLABFSN : labyrinth flexible single
	DLABFSP : labyrinth flexible stepped
	DLABFSR : labyrinth flexible straight
	DLABSN : labyrinth single
	DLABSP : labyrinth stepped
	DLABSR : labyrinth straight
	DLDOP : oil pump (proprietary)
	DLICH : channel straight
	DLICHCO : channel contraction
	DLICHDO : channel discontinuous opening
	DLICHDR : channel drop
	DLICHDS : channel discontinuous slope
	DLICHEL : channel enlargement
	DLICHRE : channel reservoir
	DLICHSG : channel sluice gate
	DLICHSO : channel sluice opening
	DLICHST : channel step
	DLICHWE : channel weir crest
	DLICHWO : channel weir slope
	DLPIBE : (liquid) pipe bend
	DLPIBR : (liquid) pipe branch (not available yet)
	DLPICO : (liquid) pipe contraction
	DLIPIDI : (liquid) pipe diaphragm
	DLPIEL : (liquid) pipe enlargement
	DLPIEN : (liquid) pipe entrance
	DLPIGV : (liquid) pipe gate valve
	DLPIMA : (liquid) pipe Manning
	DLPIMAF : (liquid) pipe Manning flexible
	DLPIWC : (liquid) pipe White-Colebrook
	DLPIWCF : (liquid) pipe White-Colebrook flexible
	DLIPU : liquid pump
	DLPBEIDC : (liquid) restrictor bend Idelchik circular
	DLPBEIDR : (liquid) restrictor bend Idelchik rectangular
	DLPBEMA : (liquid) restrictor own (proprietary)
	DLPBEMI : (liquid) restrictor bend Miller

Table 25: (continued)

variable	meaning
	DLPBRJG : (liquid) (liquid) branch joint GE
	DLPBRJI1 : (liquid) branch joint Idelchik1
	DLPBRJI2 : (liquid) (liquid) branch joint Idelchik2
	DLPBRSG : (liquid) (liquid) branch split GE
	DLPBRSI1 : (liquid) branch split Idelchik1
	DLPBRSI2 : (liquid) branch split Idelchik2
	DLPC1 : (liquid) orifice Cd=1
	DLPCO : (liquid) restrictor contraction
	DLPEL : (liquid) restrictor enlargement
	DLPEN : (liquid) restrictor entry
	DLPEX : (liquid) restrictor exit
	DLPLOID : (liquid) restrictor long orifice Idelchik
	DLLOLI : (liquid) restrictor long orifice Lichtarowicz
	DLPUS : (liquid) restrictor user
	DLPVF : (liquid) vortex free
	DLPVS : (liquid) vortex forced
	DLPWAOR : (liquid) restrictor wall orifice
	DMRGF : Moehring centrifugal
	DMRGP : Moehring centripetal
	DORBG : orifice Bragg (proprietary)
	DORBT : bleed tapping
	DORC1 : orifice Cd=1
	DORMA : orifice proprietary, rotational correction Albers (proprietary)
	DORMM : orifice McGreehan Schotsch, rotational correction McGreehan and Schotsch
	DORPA : orifice Parker and Kercher, rotational correction Albers (proprietary)
	DORPM : orifice Parker and Kercher, rotational correction McGreehan and Schotsch
	DORPN : preswirl nozzle
	DREBEIDC : restrictor bend Idelchik circular
	DREBEIDR : restrictor bend Idelchik rectangular
	DREBEMA : restrictor own (proprietary)
	DREBEMI : restrictor bend Miller
	DREBRJG : branch joint GE
	DREBRJI1 : branch joint Idelchik1
	DREBRJI2 : branch joint Idelchik2
	DREBRSG : branch split GE
	DREBRSI1 : branch split Idelchik1
	DREBRSI2 : branch split Idelchik2
	DRECO : restrictor contraction
	DREEL : restrictor enlargement

Table 25: (continued)

variable	meaning
	<p>DREEN : restrictor entrance DREEX : restrictor exit DRELOID : restrictor long orifice Idelchik DRELOLI : restrictor long orifice Lichtarowicz DREUS : restrictor user DREWAOR : restrictor wall orifice DRIMS : rim seal (proprietary) DRTA : relative to absolute DSPUMP : scavenge pump (proprietary) DVOFO : vortex forced DVOFR : vortex free Uxxxxabc : user element with type number xxxx, number of integration points a, maximum degree of freedom in any node b and number of nodes c; a,b and c are calculated internally based on the information on the *USER ELEMENT card; notice that a, b and c are the character equivalent, e.g. a=char(number of integration points)</p>
ielorien(j,i)	orientation number of layer j
ielmat(j,i)	material number of layer j
ielprop(i)	pointer to the position in field prop after which the properties for element i start (prop(ielprop(i)+1),prop(ielprop(i)+2)...); for networks and general beam sections
nuel	number of different user element types
For user element i	
iel(1,i)	type number of the user element
iel(2,i)	number of itegration points
iel(3,i)	max degree of freedom in any of the nodes
iel 4,i)	number of nodes belonging to the element
SETS AND SURFACES	
nset	number of sets (including surfaces)
ialset(i)	member of a set or surface: this is a - node for a node set or nodal surface - element for an element set - number made up of 10*(element number)+facial number for an element face surface if ialset(i)=-1 it means that all nodes or elements (depending on the kind of set) in between ialset(i-2) and ialset(i-1) are also member of the set
For set i	
set(i)	name of the set; this is the user defined name + N for node sets

Table 25: (continued)

variable	meaning
istartset(i) iendset(i)	+ E for element sets + S for nodal surfaces + T for element face surfaces pointer into ialset containing the first set member pointer into ialset containing the last set member
TIE CONSTRAINTS	
ntie For tie constraint i tieset(1,i)	number of tie constraints name of the tie constraint; for contact constraints (which do not have a name) the adjust nodal set name is stored, if any, and a C is appended at the end (C is replaced by - for deactivated contact pairs) for multistage constraints a M is appended at the end for a contact tie a T is appended at the end for submodels (which do not have a name) a fictitious name SUBMODEL <i>i</i> is used, where <i>i</i> is a three-digit consecutive number and a S is appended at the end for sensitivity sets a D is appended at the end (for design variables)
tieset(2,i)	dependent surface name + S for nodal surfaces (node-to-face contact) + T for facial surfaces (node-to-face or face-to-face contact) + M for facial surfaces (quad-quad Mortar contact) + P for facial surfaces (quad-lin Petrov Galerkin Mortar contact) + G for facial surfaces (quad-quad Petrov Galerkin Mortar contact) + O for facial surfaces (quad-lin Mortar contact)
tieset(3,i) tietol(1,i)	independent surface name + T tie tolerance; used for cyclic symmetry ties special meaning for contact pairs: > 0 for large sliding < 0 for small sliding
tietol(2,i)	if $ tietol \geq 2$, adjust value = $ tietol -2$ for contact pairs: number of the relevant interaction definition (is treated as a material) for ties: -1 means ADJUST=NO, +1 means ADJUST=YES (default)
tietol(3,i)	only for contact pairs: the clearance defined in a *CLEARANCE card

Table 25: (continued)

variable	meaning
tietol(4,i)	only for contact pairs: > 0 if reactivated with *MODEL CHANGE, ADD in the present step, else =0
CONTACT	
ncont	total number of triangles in the triangulation of all independent surfaces
ncone	total number of slave nodes in the contact formulation
mortar	-2: no contact -1: massless dynamic contact 0: node-to-surface penalty contact 1: surface-to-surface penalty contact 2: mortar contact 3: linmortar contact 4: pglmortar contact 5: pgmortar contact
For triangle i	
koncont(1..3,i)	nodes belonging to the triangle
koncont(4,i)	element face to which the triangle belongs: 10*(element number) + face number
cg(1..3,i)	global coordinates of the center of gravity
straight(1..4,i)	coefficients of the equation of the plane perpendicular to the triangle and containing its first edge (going through the first and second node of koncont)
straight(5..8,i)	idem for the second edge
straight(9..12,i)	idem for the third edge
straight(13..16,i)	coefficients of the equation of the plane containing the triangle
For contact tie constraint i	
itietri(1,i)	first triangle in field koncont of the master surface corresponding to contact tie constraint i
itietri(2,i)	last triangle in field koncont of the master surface corresponding to contact tie constraint i
SHELL (2D) AND BEAM (1D) VARIABLES (INCLUDING PLANE STRAIN, PLANE STRESS AND AXISYMMETRIC ELEMENTS)	
iponor(2,i)	two pointers for entry i of kon. The first pointer points to the location in xnor preceding the normals of entry i, the second points to the location in knor preceding the newly generated dependent nodes of entry i. The entry i relates to the unexpanded version of the element and, for element j, assumed to be stored at kon(ipkon(j)+1)...kon(ipkon(j)+m), where m is the number of 2d nodes belonging to the element

Table 25: (continued)

variable	meaning
xnor(i)	field containing the normals in nodes on the elements they belong to
knor(i)	field containing the extra nodes needed to expand the shell and beam elements to volume elements
thickn(2,i)	thicknesses (one for shells, two for beams) in node i
thicke(j,i)	thicknesses (one (j=1) for non-composite shells, two (j=1,2) for beams and n (j=1..n) for composite shells consisting of n layers) in element nodes. The entries correspond to the nodal entries in field kon
offset(2,i)	offsets (one for shells, two for beams) in element i
iponoel(i)	pointer for node i into field inoel, which stores the 1D and 2D elements belonging to the node.
inoel(3,i)	field containing an element number, a local node number within this element and a pointer to another entry (or zero if there is no other).
inoelfree	next free field in inoel
rig(i)	integer field indicating whether node i is a rigid node (nonzero value) or not (zero value). In a rigid node or knot all expansion nodes except the ones not in the midface of plane stress, plane strain and axisymmetric elements are connected with a rigid body MPC. If node i is a rigid node rig(i) is the number of the rotational node of the knot; if the node belongs to axisymmetric, plane stress and plane strain elements only, no rotational node is linked to the knot and rig(i)=-1
AMPLITUDES	
nam	# amplitude definitions
amta(1,j)	time of (time,amplitude) pair j
amta(2,j)	amplitude of (time,amplitude) pair j
namtot	total # of (time,amplitude) pairs
For amplitude i	
aname(i)	name of the amplitude
namta(1,i)	location of first (time,amplitude) pair in field amta
namta(2,i)	location of last (time,amplitude) pair in field amta
namta(3,i)	in absolute value the amplitude it refers to; if abs(namta(3,i))=i it refers to itself. If abs(namta(3,i))=j, amplitude i is a time delay of amplitude j the value of which is stored in amta(1,namta(1,i)); in the latter case amta(2,namta(1,i)) is without meaning; If namta(3,i)>0 the time in amta for amplitude i is step time, else it is total time.
TRANSFORMS	

Table 25: (continued)

variable	meaning
ntrans trab(1..6,i) trab(7,i)	# transform definitions coordinates of two points defining the transform =-1 for cylindrical transformations =1 for rectangular transformations
SINGLE POINT CONSTRAINTS	
nboun For SPC i nodeboun(i) ndirboun(i) typeboun(i) xboun(i) xbounold(i) xbounact(i) xbounini(i) iamboun(i) ikboun(i) ilboun(i)	# SPC's SPC node SPC direction SPC type (SPCs can contain the nonhomogeneous part of MPCs) A=acceleration B=prescribed boundary condition M=midplane R=rigidbody U=usermpc magnitude of constraint at end of a step magnitude of constraint at beginning of a step magnitude of constraint at the end of the present increment magnitude of constraint at the start of the present increment amplitude number for submodels the step number is inserted ordered array of the DOFs corresponding to the SPC's (DOF=8*(nodeboun(i)-1)+ndirboun(i)) original SPC number for ikboun(i)
MULTIPLE POINT CONSTRAINTS	
labmpc(i) j=ipompc(i) nodempc(1,j) nodempc(2,j) k=nodempc(3,j) coefmpc(j) nodempc(1,k) nodempc(2,k) coefmpc(k) ikmpc(i) ilmpc(i) memmpc	label of MPC i starting location in nodempc and coefmpc of MPC i node of first term of MPC i direction of first term of MPC i next entry in field nodempc for MPC i (if zero: no more terms in MPC) first coefficient belonging to MPC i node of second term of MPC i direction of second term of MPC i coefficient of second term of MPC i ordered array of the dependent DOFs corresponding to the MPC's DOF=8*(nodempc(1,ipompc(i))-1)+nodempc(2,ipompc(i)) original MPC number for ikmpc(i) upper value of sum of number of terms in all MPC's

Table 25: (continued)

variable	meaning
mpcend maxlenmpc icascade	last occupied entry in nodempc and coefmpc maximum number of terms in any MPC 0 : MPC's did not change since the last iteration 1 : MPC's changed since last iteration : dependency check in cascade.c necessary 2 : at least one nonlinear MPC had DOFs in common with a linear MPC or another nonlinear MPC. dependency check is necessary in each iteration
FORCE CONSTRAINTS	
nfc coeffc(0,i) coeffc(1..6,i) ndc ikdc(i) idc(1,i) idc(2,i) idc(3,i)	number of force constraints dof in the coupling surface corresponding to constraint i in the form dof=10*node+dir coefficients for constraint i number of distributing couplings dof of distributing coupling i in the form dof=8*(refnode-1)+refdir first constraint in field coeffc for distributing coupling i last constraint in field coeffc for distributing coupling i orientation for distributing coupling i
POINT LOADS	
nforc For point load i nodeforc(1,i) nodeforc(2,i) ndirforc(i) xforc(i) xforcold(i) xforcact(i) iamforc(i) idefforc(i) ikforc(i) ilforc(i)	# of point loads node in which force is applied sector number, if force is real; sector number + # sectors if force is imaginary (only for modal dynamics and steady state dynamics analyses with cyclic symmetry) direction of force magnitude of force at end of a step magnitude of force at start of a step actual magnitude amplitude number 0: no force was defined for this node and direction on the same sector before within the actual step 1: at least one force was defined for this node and direction on the same sector before within the actual step ordered array of the DOFs corresponding to the point loads (DOF=8*(nodeboun(i)-1)+ndirboun(i)) original SPC number for ikforc(i)
FACIAL DISTRIBUTED LOADS	
nload For distributed load i	# of facial distributed loads

Table 25: (continued)

variable	meaning
nelemload(1,i) nelemload(2,i)	element to which distributed load is applied node for the environment temperature (only for heat transfer analyses); sector number, if load is real; sector number + # sectors if load is imaginary (only for modal dynamics and steady state dynamics analyses with cyclic symmetry)
sideload(i) xload(1,i)	load label; indicated element side to which load is applied magnitude of load at end of a step or, for heat transfer analyses, the convection (*FILM) or the radiation coefficient (*RADIATE)
xload(2,i)	the environment temperature (only for heat transfer analyses)
xloadold(1..2,i) xloadact(1..2,i)	magnitude of load at start of a step actual magnitude of load
iamload(1,i)	amplitude number for xload(1,i) for submodels the step number is inserted
iamload(2,i) idefload(i)	amplitude number for xload(2,i) 0: no load was defined on the same element with the same label and on the same sector before within the actual step 1: at least one load was defined on the same element with the same label and on the same sector before within the actual step
MASS FLOW RATE	
nflow	# of network elements
TEMPERATURE LOADS	
t0(i) t1(i) t1old(i) t1act(i) iamt1(i)	initial temperature in node i at the start of the calculation temperature at the end of a step in node i temperature at the start of a step in node i actual temperature in node i amplitude number
MECHANICAL BODY LOADS	
nbody For body load i ibody(1,i)	# of mechanical body loads code identifying the kind of body load 1: centrifugal loading 2: gravity loading with known gravity vector 3: generalized gravity loading 4: Coriolis (for steady state dynamics)
ibody(2,i) ibody(3,i) cbody(i) xbody(1,i) xbody(2..4,i)	amplitude number for load i load case number for load i element number or element set to which load i applies size of the body load for centrifugal loading: point on the axis

Table 25: (continued)

variable	meaning
xbody(5..7,i) xbodyact(1,i) xbodyact(2..7,i) idefbody(i)	for gravity loading with known gravity vector: normalized gravity vector for centrifugal loading: normalized vector on the rotation axis actual magnitude of load identical to the corresponding entries in xbody 0: no body load was defined on the same set with the same code and the same load case number before within the actual step 1: at least one body load was defined on the same set with the same code and the same load case number before within the actual step
For element i ipobody(1,i) ipobody(2,i)	body load applied to element i, if any, else 0 index referring to the line in field ipobody containing the next body load applied to element i, i.e. ipobody(1,ipobody(2,i)), else 0
STRESS, STRAIN AND ENERGY FIELDS	
eei(i,j,k)	in general : Lagrange strain component i in integration point j of element k (linear strain in linear elastic calculations) for elements with DEFORMATION PLASTICITY property: Eulerian strain component i in integration point j of element k (linear strain in linear elastic calculations)
eeini(i,j,k)	Lagrange strain component i in integration point of element k at the start of an increment
een(i,j)	Lagrange strain component i in node j (mean over all adjacent elements linear strain in linear elastic calculations)
stx(i,j,k)	Cauchy or PK2 stress component i in integration point j of element k at the end of an iteration (linear stress in linear elastic calculations). For spring elements stx(1..3,1,k) contains the relative displacements for element k and stx(4..6,1,k) the contact stresses
sti(i,j,k)	PK2 stress component i in integration point j of element k at the start of an iteration (linear stress in linear elastic calculations)
stiini(i,j,k)	PK2 stress component i in integration point j of element k at the start of an increment
stn(i,j)	Cauchy stress component i in node j (mean over all adjacent elements; "linear" stress in linear elastic calculations)
ener(1,j,k)	strain energy in integration point j of element k;

Table 25: (continued)

variable	meaning
ener(2,j,k)	kinetic energy in integration point j of element k; if k is a contact spring element: friction energy (j=1)
enerini(1,j,k)	strain energy in integration point of element k at the start of an increment
enerini(2,j,k)	kinetic energy in integration point j of element k at the start of an increment; if k is a contact spring element: friction energy at the start of an increment(j=1)
enern(j)	strain energy in node j (mean over all adjacent elements)
THERMAL ANALYSIS	
ithermal(1) (in this manual also called ithermal)	0 : no temperatures involved in the calculation 1 : stress analysis with given temperature field 2 : thermal analysis (no displacements) 3 : coupled thermal-mechanical analysis : temperatures and displacements are solved for simultaneously 4 : uncoupled thermal-mechanical analysis : in a new increment temperatures are solved first, followed by the displacements
ithermal(2)	used to determine boundary conditions for plane stress, plane strain and axisymmetric elements 0 : no temperatures involved in the calculation 1 : no heat transfer nor coupled steps in the input deck 2 : no mechanical nor coupled steps in the input deck 3 : at least one mechanical and one thermal step or at least one coupled step in the input deck
v(0,j)	temperature of node j at the end of an iteration (for ithermal > 1)
vold(0,j)	temperature of node j at the start of an iteration (for ithermal > 1)
vini(0,j)	temperature of node j at the start of an increment (for ithermal > 1)
fn(0,j)	actual temperature at node j (for ithermal > 1)
qfx(i,j,k)	heat flux component i in integration point j of element k at the end of an iteration
qfn(i,j)	heat flux component i in node j (mean over all adjacent elements)
DISPLACEMENTS AND SPATIAL/TIME DERIVATIVES	
v(i,j)	displacement of node j in direction i at the end of an iteration
vold(i,j)	displacement of node j in direction i at the start of an iteration
vini(i,j)	displacement of node j in direction i at the start of an increment

Table 25: (continued)

variable	meaning
ve(i,j)	velocity of node j in direction i at the end of an iteration
veold(i,j)	velocity of node j in direction i at the start of an iteration
veini(i,j)	velocity of node j in direction i at the start of an increment
accold(i,j)	acceleration of node j in direction i at the start of an iteration
accini(i,j)	acceleration of node j in direction i at the start of an increment
vk(i,j)	(i,j) component of the displacement gradient tensor at the end of an iteration
xkl(i,j)	(i,j) component of the deformation gradient tensor at the end of an iteration
xikl(i,j)	(i,j) component of the deformation gradient tensor at the start of an increment
ckl(i,j)	(i,j) component of the inverse of the deformation gradient tensor
LINEAR EQUATION SYSTEM	
nasym	0: symmetrical system 1: asymmetrical system
ad(i)	element i on diagonal of stiffness matrix
au(i)	element i in lower triangle of stiffness matrix
irow(i)	row of element i in field au (i.e. au(i))
icol(i)	number of subdiagonal nonzero's in column i (only for symmetric matrices)
jq(i)	location in field irow of the first subdiagonal nonzero in column i (only for symmetric matrices)
adb(i)	element i on diagonal of mass matrix, or, for buckling, of the incremental stiffness matrix (only nonzero elements are stored)
aub(i)	element i in upper triangle of mass matrix, or, for buckling, of the incremental stiffness matrix (only nonzero elements are stored)
neq[0]	# of mechanical equations
neq[1]	sum of mechanical and thermal equations
neq[2]	neq[1] + # of single point constraints (only for modal calculations)
nzl	number of the column such that all columns with a higher column number do not contain any (projected) nonzero off-diagonal terms (\leq neq[1])
nzs[0]	sum of projected nonzero mechanical off-diagonal terms
nzs[1]	nzs[0]+sum of projected nonzero thermal off-diagonal terms
nzs[2]	nzs[1] + sum of nonzero coefficients of SPC degrees of freedom (only for modal calculations)

Table 25: (continued)

variable	meaning
nactdof(i,j)	>0: actual degree of freedom (in the system of equations) of DOF i of node j <0 and even: -nactdof(i,j)/2 is the SPC number applied to this degree of freedom <0 and odd: (-nactdof(i,j)+1)/2 is the MPC number for which this degree of freedom constitutes the dependent term
inputformat	=0: matrix is symmetric; lower triangular matrix is stored in fields ad (diagonal), au (subdiagonal elements), irow, icol and jq. =1: matrix is not symmetric. Diagonal and subdiagonal entries are stored as for inputformat=0; The superdiagonal entries are stored at the end of au in exactly the same order as the symmetric subdiagonal counterpart
INTERNAL AND EXTERNAL FORCES	
fext(i)	external mechanical forces in DOF i (due to point loads and distributed loads, including centrifugal and gravity loads, but excluding temperature loading and displacement loading)
fextini(i)	external mechanical forces in DOF i (due to point loads and distributed loads, including centrifugal and gravity loads, but excluding temperature loading and displacement loading) at the end of the last increment
finc(i)	external mechanical forces in DOF i augmented by contributions due to temperature loading and prescribed displacements; used in linear calculations only
f(i)	actual internal forces in DOF i due to : actual displacements in the independent nodes; prescribed displacements at the end of the increment in the dependent nodes; temperatures at the end of the increment in all nodes
fini(i)	internal forces in DOF i at the end of the last increment
b(i)	right hand side of the equation system : difference between fext and f in nonlinear calculations; for linear calculations, b=finc.
fn(i,j)	actual force at node j in direction i
INCREMENT PARAMETERS	
jmax(1)	in a *SUBSTRUCTURE GENERATE procedure: if 1: FILE=USER DEFINED if 2: FILE=MATRIX in all other procedures: maximum number of thermomechanical increments

Table 25: (continued)

variable	meaning
jmax(2)	maximum number of CFD increments
tinc	user given increment size (can be modified by the program if the parameter DIRECT is not activated)
tper	user given step size
dtheta	normalized (by tper) increment size
theta	normalized (by tper) size of all previous increments (not including the present increment)
retime	theta+dtheta
dtime	real time increment size
time	real time size of all previous increments INCLUDING the present increment
ttime	real time size of all previous steps
DIRECT INTEGRATION DYNAMICS	
alpha[0]	parameter in the alpha-method of Hilber, Hughes and Taylor
alpha[1]	if > 1: a transformation from a local rotating system to the global fixed system should be applied before starting the calculation else: no such transformation should be applied
bet,gam	parameters in the alpha-method of Hilber, Hughes and Taylor
iexpl	=0 : implicit dynamics =1 : explicit dynamics
mscalmethod	< 0: no explicit dynamics 0: explicit dyn., no mass nor contact spring scaling 1: explicit dyn., mass scaling, no contact spring scaling 2: explicit dyn., no mass scaling, contact spring scaling 3: explicit dyn., mass scaling and contact spring scaling
smscale(i)	scaling coefficient for element i if i <= ne0: mass scaling coefficient if i > ne0: contact spring scaling coefficient
FREQUENCY CALCULATIONS	
mei[0]	number of requested eigenvalues
mei[1]	number of Lanczos vectors
mei[2]	maximum number of iterations
mei[3]	if 1: store eigenfrequencies, eigenmodes, mass matrix and possibly stiffness matrix in .eig file, else 0
fei[0]	tolerance (accuracy)
fei[1]	lower value of requested frequency range
fei[2]	upper value of requested frequency range
CYCLIC SYMMETRY CALCULATIONS	
mcs	number of cyclic symmetry parts

Table 25: (continued)

variable	meaning
ics	one-dimensional field; contains all independent nodes, one part after the other, and sorted within each part
racs	one-dimensional field; contains the corresponding radial coordinates
zacs	one-dimensional field; contains the corresponding axial coordinates
For cyclic symmetry part i	
cs(1,i)	number of segments in 360°
cs(2,i)	minimum nodal diameter
cs(3,i)	maximum nodal diameter
cs(4,i)	number of nodes on the independent side
cs(5,i)	number of sections to be plotted
cs(6..12,i)	coordinates of two points on the cyclic symmetry axis
cs(13,i)	if $i > 0$: number of the element set (e.g. for plotting purposes) if $i < 0$: -cs(13,i) is the number of a substructure element (also called superelement)
cs(14,i)	total number of independent nodes in all previously defined cyclic symmetry parts
cs(15,i)	$\cos(\text{angle})$ where $\text{angle} = 2*\pi/\text{cs}(1,\text{mcs})$
cs(16,i)	$\sin(\text{angle})$ where $\text{angle} = 2*\pi/\text{cs}(1,\text{mcs})$
cs(17,i)	number of tie constraint
MODAL DYNAMICS AND STEADY STATE DYNAMICS CALCULATIONS	
For Rayleigh damping (modal and steady state dynamics)	
xmodal(1)	α_m (first Rayleigh coefficient)
xmodal(2)	β_m (second Rayleigh coefficient)
For steady state dynamics	
xmodal(3)	lower frequency bound f_{min}
xmodal(4)	upper frequency bound f_{max}
xmodal(5)	number of data points $n_{data} + 0.5$
xmodal(6)	bias
xmodal(7)	if harmonic: -0.5; if not harmonic: number of Fourier coefficients + 0.5
xmodal(8)	lower time bound t_{min} for one period (nonharmonic loading)
xmodal(9)	upper time bound t_{max} for one period (nonharmonic loading)
For damping (modal and steady state dynamics)	
xmodal(10)	internal number of node set for which results are to be calculated
xmodal(11)	for Rayleigh damping: -0.5 for direct damping: largest mode for which ζ is defined +0.5

Table 25: (continued)

variable	meaning
	For direct damping
xmodal(12..	values of the ζ coefficients
imddof(*)	dofs which are retained (requested output, applied loads..)
nmddof	number of dofs in imddof
imdnode(*)	nodes which are retained (requested output, contact nodes..)
nmdnode	number of nodes in imdnode
imdboun(*)	boundary conditions needed at retained nodes
nmdboun	size of field imdboun
imdmpc(*)	MPCs needed at retained nodes
nmdmpc	size of field imdmpc
imdelem(*)	elements which are retained (calculation of stresses at the integration points....)
nmdelem	size of field imdelem
iznode(*)	nodes in imdnode + nodes with loading (user and non-user); only the results in the nodes in iznode are mapped onto the other sectors
nznnode	size of field iznode
izdof(*)	retained dofs: dofs in imddof + dofs in nodes with non-user loads and dloads; only those dofs are stored in field z
nzdof	size of field izdof
OUTPUT IN .DAT FILE	
prset(i)	node or element set corresponding to output request i
prlab(i)	label corresponding to output request i. It contains 6 characters. The first 4 are reserved for the field name, e.g. 'U' for displacements, the fifth for the value of the TOTALS parameter ('T' for TOTALS=YES, 'O' for TOTALS=ONLY and ' ' else) and the sixth for the value of the GLOBAL parameter ('G' for GLOBAL=YES and 'L' for GLOBAL=NO).
nprint	number of print requests

Table 25: (continued)

variable	meaning
OUTPUT IN .FRD FILE	

Table 25: (continued)

variable	meaning
filab(i)	<p>label corresponding to output field i. It contains 6 characters for the kind of output and 81 characters for the node set for which the output is requested, if any. The first 4 are reserved for the field name. The order is fixed: filab(1)='U ', filab(2)='NT ', filab(3)='S ', filab(4)='E ', filab(5)='RF ', filab(6)='PEEQ', filab(7)='ENER', filab(8)='SDV ', filab(9)='HFL ', filab(10)='RFL ', filab(11)='PU ', filab(12)='PNT ', filab(13)='ZZS ', filab(14)='TT ', filab(15)='MF ', filab(16)='PT ', filab(17)='TS ', filab(18)='PHS ', filab(19)='MAXU', filab(20)='MAXS', filab(21)='V ', filab(22)='PS ', filab(23)='MACH', filab(24)='CP ', filab(25)='TURB', filab(26)='CONT ', filab(27)='CELS ', filab(28)='DEPT ', filab(29)='HCRI ', filab(30)='MAXE', filab(31)='PRF ', filab(32)='ME ', filab(33)='HER', filab(34)='VF ', filab(35)='PSF ', filab(36)='TSF ', filab(37)='PTF ', filab(38)='TTF ', filab(39)='SF ', filab(40)='HFLF', filab(41)='SVF ', filab(42)='ECD ', filab(43)='POT ', filab(44)='EMFE', filab(45)='EMFB', filab(46)='PCON', filab(47)='SEN ', filab(48)='RM ' (the latter refers to mesh refinement), filab(49)='DEPF', filab(50)='DTF ', filab(51)='SNEG', filab(52)='SMID', filab(53)='SPOS', filab(54)='KEQ ', filab(55)='THE '. Results are stored for the complete mesh. A field is not selected if the first 4 characters are blank, e.g. the stress is not stored if filab(3)(1:4)=' '. An exception to this rule is formed for filab(1): here, only the first two characters are used and should be either 'U ' or ' ', depending on whether displacements are requested are not. The third character takes the value 'C' if the user wishes that the contact elements in each iteration of the last increment are stored in dedicated files, else it is blank. The fourth character takes the value 'I' if the user wishes that the displacements of the iterations of the last increment are stored (used for debugging in case of divergence), else it is blank. If the mesh contains 1D or 2D elements, the fifth character takes the value 'I' if the results are to be interpolated, 'M' if the section forces are requested instead of the stresses and 'E' if the 1D/2D element results are to be given on the expanded elements. In all other cases the fifth character is blank: ' '. The sixth character contains the value of the GLOBAL parameter ('G' for GLOBAL=YES and 'L' for GLOBAL=NO). The entries filab(13)='RFRES ' and filab(14)='RFLRES' are reserved for the output of the residual forces and heat fluxes in case of no convergence and cannot be selected by the user: the residual forces and heat fluxes are automatically stored if the calculation stops due to divergence.</p>

Table 25: (continued)

variable	meaning
inum(i)	=-1: network node =1: structural node or 3D fluid node
CONVECTION NETWORKS	
ntg	number of gas nodes
For gas node i	
itg(i)	global node number
nactdog(j,i)	if $\neq 0$ indicates that degree of freedom j of gas node i is an unknown; the nonzero number is the column number of the DOF in the convection system of equations. The physical significance of j depends on whether the node is a midside node or corner node of a fluid element: j=0 and corner node: total temperature j=1 and midside node: mass flow j=2 and corner node: total pressure j=3 and midside node: geometry (e.g. α for a gate valve)
nacteq(j,i)	if $\neq 0$ indicates that equation type j is active in gas node i; the nonzero number is the row number of the DOF in the convection system of equations. The equation type of j depends on whether the node is a midside node or corner node of a network element: j=0 and corner node: conservation of energy j=1 and corner node: conservation of mass j=2 and midside node: conservation of momentum
ineighe(i)	only for gas network nodes (no liquids): if 0: itg(i) is a midside node if -1: itg(i) is a chamber if > 0 : ineighe(i) is a gas pipe element itg(i) belongs to
v(j,i)	value of degree of freedom j in node i (global numbering). The physical significance of j depends on whether the node is a midside node or corner node of a network element: j=0 and corner node: total temperature j=1 and midside node: mass flow j=2 and corner node: total pressure j=3 and corner node: static temperature j=3 and midside node: geometry
nflow	number of network elements
ieg(i)	global element number corresponding to network element i
network	if 0: no network if 1: defined as purely thermal by the user on the *STEP card (only unknowns: total temperature; simultaneous solution)

Table 25: (continued)

variable	meaning
	if 2: purely thermal (alternating solution (presence of Dx-elements) or simultaneous (no Dx elements)) if 3: coupled thermodynamic network (alternating solution) if 4: purely aerodynamic (total temperature is known everywhere; alternating solution)
THERMAL RADIATION	
ntr	number of element faces loaded by radiation = radiation faces
iviewfile	-2: NO CHANGE option on the *VIEWFACTOR card, no reading, no calculating, no writing -1: reading the viewfactors from file, no writing 1: calculating the viewfactors, no writing 2: calculating the viewfactors, writing to file and continuing 3: calculating the viewfactors, stop after storing the viewfactors to file
For radiation face i	
kontri(1..3,j)	nodes belonging to triangle j
kontri(4,j)	radiation face number (> 0 and \leq ntri) to which triangle j belongs
nloadtr(i)	distributed load number (> 0 and \leq nload) corresponding to radiation face i
ITERATION VARIABLES	
istep	step number
iinc	increment number
iit	iteration number = -1 only before the first iteration in the first increment of a step = 0 before the first iteration in an increment which was repeated due to non-convergence or any other but the first increment of a step > 0 denotes the actual iteration number
PHYSICAL CONSTANTS	
physcon(1)	Absolute zero
physcon(2)	Stefan-Boltzmann constant
physcon(3)	Newton Gravity constant
physcon(4)	Static temperature at infinity (for 3D fluids)
physcon(5)	Velocity at infinity (for 3D fluids)
physcon(6)	Static pressure at infinity (for 3D fluids)
physcon(7)	Density at infinity (for 3D fluids)
physcon(8)	Typical size of the computational domain (for 3D fluids)

Table 25: (continued)

variable	meaning
physcon(9)	Turbulence parameter if $0 \leq \text{physcon}(9) < 1$: laminar if $1 \leq \text{physcon}(9) < 2$: k- ϵ Model if $2 \leq \text{physcon}(9) < 3$: q- ω Model if $3 \leq \text{physcon}(9) < 4$: SST Model
physcon(11)	number of eigenvectors used in the creation of a random field
physcon(12)	standard deviation used in the creation of a random field
physcon(13)	correlation length used in the creation of a random field
physcon(14)	shock smoothing coefficient (CFD method)
COMPUTATIONAL FLUID DYNAMICS	
vold(0,i)	Static temperature in node i
vold(1..3,i)	Velocity components in node i
vold(4,i)	Pressure in node i
voldaux(0,i)	Total energy density $\rho\epsilon_t$ in node i
voldaux(1..3,i)	Momentum density components ρv_i in node i
voldaux(4,i)	Density ρ in node i
v(0,i)	Total energy density correction in node i
v(1..3,i)	Momentum density correction components in node i
v(4,i)	For fluids: Pressure correction in node i For gas: Density correction in node i
ELECTROMAGNETICS	
vold(0,i)	Static temperature in node i
vold(1..3,i)	Magnetic vector potential \mathbf{A} (domain 2 or 3) in node i
vold(4,i)	Electric scalar potential V (domain 2) in node i
vold(5,i)	Magnetic scalar potential P (domain 1) in node i
sti(1..3,j,k)	Electric field in the $\mathbf{A}-V$ domain (domain 2) in integration point j of element k
sti(4..6,j,k)	Magnetic field in any domain in integration point j of element k
neq[0]	# of electromagnetic equations (covering the magnetic scalar potential in domain 1, the magnetic vector potential and electric scalar potential in domain 2 and the magnetic vector potential in domain 3)
neq[1]	sum of electromagnetic and thermal equations
nzs[0]	sum of projected nonzero electromagnetic off-diagonal terms
nzs[1]	nzs[0]+sum of projected nonzero thermal off-diagonal terms
h0ref(1..3,i)	magnetic intensity in infinite space due to the nominally applied electrical potential across the coils
h0(1..3,i)	magnetic intensity in infinite space due to the actually applied electrical potential across the coils

Table 25: (continued)

variable	meaning
CONVERGENCE PARAMETERS	
qa[0]	\bar{q}_i^α for the mechanical forces (average force)
qa[1]	\bar{q}_i^α for the thermal forces (average flux)
qa[2]	-1: no time increment decrease >0: time increment multiplication factor (< 1) due to divergence in a material routine
qa[3]	maximum of the change of the viscoplastic strain within a given increment over all integration points in all elements
qam[0]	\tilde{q}_i^α for the mechanical forces
qam[1]	\tilde{q}_i^α for the concentrated heat flux
ram[0]	$r_{i,max}^\alpha$ for the mechanical forces
ram[1]	$r_{i,max}^\alpha$ for the concentrated heat flux
ram[2]	the node corresponding to ram[0]
ram[3]	the node corresponding to ram[1]
ram[4]	ram[0] (present iteration) + ram[0] (previous iteration
ram[5]	number of contact elements (present iteration) - number of contact elements (previous iteration)
uam[0]	$\Delta u_{i,max}^\alpha$ for the displacements
uam[1]	$\Delta u_{i,max}^\alpha$ for the temperatures
cam[0]	$c_{i,max}^\alpha$ for the displacements
cam[1]	$c_{i,max}^\alpha$ for the temperatures
cam[2]	largest temperature change within the increment
cam[3]	node corresponding to cam[0]
cam[4]	node corresponding to cam[1]
for networks	
uamt	largest increment of gas temperature
camt[0]	largest correction to gas temperature
camt[1]	node corresponding to camt[0]
uamf	largest increment of gas massflow
camf[0]	largest correction to gas massflow
camf[1]	node corresponding to camt[0]
uamp	largest increment of gas pressure
camp[0]	largest correction to gas pressure
camp[1]	node corresponding to camt[0]
iflagact	0: number of contact elements did not significantly change between present and previous iteration 1: else (i.e. did significantly change)
THREE-DIMENSIONAL INTERPOLATION	
cotet(1..3,i)	coordinates of nodes i
kontet(1..4,i)	nodes belonging to tetrahedron i
ipofa(i)	entry in field inodfa pointing to a face for which node i is the smallest number

Table 25: (continued)

variable	meaning
inodfa(1..3,i) inodfa(4,i)	nodes j , k and l belonging to face i such that $j < k < l$ number of another face for which inodfa(1,i) is the smallest number. If no other exists the value is zero
planfa(1..4,i)	coefficients a , b , c and d of the plane equation $ax+by+cz+d=0$ of face i
ifatet(1..4,i)	faces belonging to tetrahedron i . The sign identifies the half space to which i belongs if evaluating the plane equation of the face

It is important to notice the difference between cam[1] and cam[2]. cam[1] is the largest change within an iteration of the actual increment. If the corrections in subsequent iterations all belonging to the same increment are 5,1,0.1, the value of cam[1] is 5. cam[2] is the largest temperature change within the increment, in the above example this is 6.1.

Table 26: Contents of the field tieset.

tieset(1) (1:80)	tieset(1) (81:81)	tieset(2)	tieset(3)	meaning
Adjust node set	C	Slave set	Master set	Contact
Tie name	M	Slave set	Master set	Multistage
Tie name	P	Slave set	Master set	Fluid periodic
Tie name		Slave set	Master set	Cyclic symmetry
Type (COORDINATE or ORIENTATION)	D	Design variable node set		Design variables
Tie name	T	Slave set	Master set	Tie
	S	(1:10) Number of node or face set (11:11) type ('N' for nodal, 'T' for face)	(1:10) Number of global element set	Submodel
Tie name	Z	Slave set	Master set	Fluid cyclic

11 Verification examples.

The verification examples are simple examples suitable to test distinct features. They can be used to check whether the installation of CalculiX is correct, or to find examples when using a new feature. All verification examples are stored in `ccx_2.21.test.tar.bz2`. The larger fluid examples can be found in `ccx_2.21.fluidtest.tar.bz2`, the larger structural examples in `ccx_2.21.structest.tar.bz2`.

References

- [1] ABAQUS Theory Manual. Hibbitt, Karlsson & Sorensen, Inc., 1080 Main Street, Pawtucket, RI 02860-4847, U.S.A. (1997).
- [2] Anderson, J.D.Jr., *Introduction to flight*. Mc Graw-Hill International Editions (1989).
- [3] Ashcraft, C., Grimes, R.G., Pierce, D.J., and Wah, D.K., The User Manual for SPOOLES, Release 2.0: An object oriented software library for solving sparse linear systems of equations. Boeing Shared Services Group, P.O. Box 24346, Mail Stop 7L-22, Seattle, Washington 98124 U.S.A. (1998).
- [4] Ashcraft, C. and Wah, D.K., The Reference Manual for SPOOLES, Release 2.0: An object oriented software library for solving sparse linear systems of equations. Boeing Shared Services Group, P.O. Box 24346, Mail Stop 7L-22, Seattle, Washington 98124 U.S.A. (1998).
- [5] Ashcroft, N.W., and Mermin, N.D., *Solid State Physics*. Saunders College, Philadelphia (1976).
- [6] Ashdown, I., *Radiosity: A Programmer's Perspective*. Wiley, New York (1994).
- [7] Barlow, J., Optimal stress locations in finite element models. *Int. J. Num. Meth. Engng.* **10** , 243-251 (1976).
- [8] Beatty, M.F., Topics in finite elasticity: hyperelasticity of rubber, elastomers, and biological tissues - with examples. *Appl. Mech. Rev.* **40(12)** , 1699-1734 (1987).
- [9] Belytschko, T., Liu, W.K. and Moran, B., *Nonlinear Finite Elements for Continua and Structures*. John Wiley & Sons, New York (2001).
- [10] Berlamont, J., *Hydraulica*. Katholieke Universiteit Leuven, Belgium (1980).
- [11] Berlamont, J., *Theorie van de verhanglijnen*. Katholieke Universiteit Leuven, Belgium (1980).
- [12] Bernhardt, O.-E., Private Communication, University of Applied Sciences Karlsruhe (2014).

- [13] Bohl, W., *Technische Strömungslehre*. Vogel Würzburg Verlag, (1980).
- [14] Bragg, S.L., Effect of compressibility on the discharge coefficient of orifices and convergent nozzles. *Journal of Mechanical Engineering*. **2**(1) , 35-44 (1960).
- [15] Carter, J.E., Numerical solutions of the Navier-Stokes equations for the supersonic laminar flow over a two-dimensional compression corner. *NASA TR R-385 Report* (1972).
- [16] Chanson, H., *The hydraulics of open channel flow: an introduction*. Elsevier Butterworth-Heinemann, Oxford (2004).
- [17] Chen, L., Bletzinger, K.-U., Geiser, A. and Wüchner, R., A modified search direction method for inequality constrained optimization problems using the singular-value decomposition of normalized response gradients. *Structural and Multidisciplinary Optimization*. <https://doi.org/10.1007/s00158-019-02320-9>.
- [18] Ciarlet, P.G., *Mathematical Elasticity, Volume I: Three-dimensional Elasticity*. North Holland, New York (1988).
- [19] Clausen, J., Damkilde, L., Anderson, L., Efficient return algorithms for associated plasticity with multiple yield planes. *Int. J. Num. Meth. Engng.* **66** , 1036-1059 (2006).
- [20] Clausen, J., *Efficient Non-Linear Finite Element Implementation of Elastoplasticity for Geotechnical Problems*. Ph.D. Thesis, Esbjerg Institute of Technology, Aalborg University (2007).
- [21] Crossley, A.J., *Accurate and efficient numerical solutions for the Saint Venant equations of open channel flow*. Ph.D. Thesis, University of Nottingham (1999).
- [22] Czech, C., *Efficiency evaluation of explicit finite element methods*. Master Thesis, Technical University of Munich, Department of Civil, Geo and Environmental Engineering, Germany (2019).
- [23] Dhondt, G., *The Finite Element Method for Three-Dimensional Thermo-mechanical Applications*. John Wiley & Sons, (2004).
- [24] Egli, A., The Leakage of Steam Through Labyrinth Seals. *Trans. ASME.* **57** , 115-122 (1935).
- [25] Eringen, A.C., *Mechanics of Continua*. Robert E. Krieger Publishing Company, Huntington, New York (1980).
- [26] Ferziger, J.H. and Perić, M., *Computational Methods for Fluid Dynamics*, third rev. edition. Springer (2002).

- [27] Fitzpatrick, R., *Maxwell's Equations and the Principles of Electromagnetism*. Infinity Science Press LLC, Hingham, Massachusetts (2008).
- [28] Flanagan, D.P. and Belytschko, T., Uniform strain hexahedron and quadrilateral with orthogonal hourglass control. *Int. J. Num. Meth. Eng.* **17** , 679-706 (1981).
- [29] George, P.-L. and Borouchaki, H., *Triangulation de Delaunay et maillage*. Hermes, Paris (1997).
- [30] Greitzer, E.M., Tan, C.S. and Graf, M.B., *Internal Flow*. Cambridge University, Cambridge, UK (2004).
- [31] Hamrock, B.J., Schmid, S.R. and Jacobson, B.O. *Fundamentals of Fluid Film Lubrication*, 2nd Edition. Marcel Dekker Inc., New York (2004).
- [32] Harr, M.E., *Groundwater and Seepage*. Dover Publications Inc., New York (1990).
- [33] Hartmann, S., *Kontaktanalyse dünnwandiger Strukturen bei großen Deformationen*. Ph.D. Thesis, Institut für Baustatik und Baudynamik, Universität Stuttgart (2007).
- [34] Hay, N. and Spencer, A., Discharge coefficients of cooling holes with radiused and chamfered inlets. *ASME* 91-GT-269 (1991).
- [35] Holzapfel, G.A., Gasser, T.C. and Ogden, R.W., A New Constitutive Framework for Arterial Wall Mechanics and a Comparative Study of Material Models. *J. Elasticity* **61**, 1-48 (2000).
- [36] Hüeber, S., *Discretization techniques and efficient algorithms for contact problems*. Ph.D. Thesis, Institut für Angewandte Analysis und Numerische Simulation, Universität Stuttgart (2008).
- [37] Hughes, T.J.R., *The Finite Element Method*. Dover Publications Inc., Mineola, New York (2000).
- [38] Idelchik, I.E., *Handbook of Hydraulic Resistance*, 2nd Edition. Hemisphere Publishing Corp (1986).
- [39] Incropera, F.P. and DeWitt, D.P., *Fundamentals of Heat and Mass Transfer*. John Wiley & Sons, New York (2002).
- [40] Johnson, G.R. and Cook, W.H., A constitutive model and data for metals subjected to large strains, high strain rates and high temperatures. *Proceedings of the 7th International Symposium on Ballistics* , The Hague, 19-21 April 1983, 541-547.
- [41] Jones, W.P. and Launder, B.E., The prediction of laminarization with a two-equation model of turbulence. *Int. J. Heat Mass Transfer* **15** , 301-314 (1972).

- [42] Köhl, M., Dhondt, G. and Broede, J., Axisymmetric substitute structures for circular disks with noncentral holes. *Computers & Structures* **60**(6) , 1047-1065 (1996).
- [43] Kuczmann, Miklós, *Potential formulations in magnetics applying the finite element method*. Lecture notes, Laboratory of Electromagnetic Fields, “Széchenyi István” University, Győr, Hungary (2009).
- [44] Kundu, P.K. and Cohen, I.M., *Fluid Mechanics* (second edition). Academic Press (2002).
- [45] Kutz, K.J. and Speer, T.M., Simulation of the secondary air system of aero engines. *Transactions of the ASME* **116** (1994).
- [46] Lapidus, L. and Pinder, G.F., *Numerical solution of partial differential equations in science and engineering*. John Wiley & Sons, New York (1982).
- [47] Laursen, T.A., *Computational Contact and Impact Mechanics*. Springer-Verlag, Berlin Heidelberg New York (2003).
- [48] Lehoucq, R.B., Sorensen, D.C. and Yang, C., *ARPACK Users’ Guide, Solution of Large-Scale Eigenvalue Problems with Implicitly Restarted Arnoldi Methods*. (1998).
- [49] Leine, R.I. and van de Wouw, N., *Stability and Convergence of Mechanical Systems with Unilateral Constraints*. Lecture Notes in Applied and Computational Mechanics Vol 36. Springer Verlag Berlin Heidelberg (2008).
- [50] Lichtarowicz, A., Duggins, R.H. and Markland, E., Discharge coefficient for incompressible non cavitating flow through long orifices. *Journal of Mechanical Engineering Sciences* **7**(2) , 210-219 (1965).
- [51] Liew, K.M. and Lim, C.W., A higher-order theory for vibration of doubly curved shallow shells. *Journal of Applied Mechanics* **63** , 587-593 (1996).
- [52] Luenberger, D.G., *Linear and nonlinear programming*. Addison-Wesley Publishing Company, Reading, Massachusetts (1984).
- [53] Marsden, J.E. and Hughes, T.J.R., *Mathematical foundations of elasticity*. Dover Publications Inc, New York (1993).
- [54] Mazza, L., *Überprüfung eines elasto-plastischen Materialmodells zur Beschreibung des Werkstoffverhaltens bei dynamischer Beanspruchung während Explosionen in Rohrsystemen*. Master Thesis, Hochschule Karlsruhe, University of Applied Sciences (2020).
- [55] McGreehan, W.F. and Schotsch, M.J., Flow Characteristics of Long Orifices With Rotation and Corner Radius. *ASME-Paper*, 87-GT-162, 1-6 (1987).

- [56] Meirovitch, L., *Analytical Methods in Vibrations*. The MacMillan Company, Collier MacMillan Limited, London (1967).
- [57] Menter, F.R., Two-Equation Eddy-Viscosity Turbulence Models for Engineering Applications. *AIAA Journal* **32(8)** , 1598-1605 (1994).
- [58] Méric, L., Poubanne, P. and Cailletaud, G., Single Crystal Modeling for Structural Calculations: Part 1 - Model Presentation. *Journal of Engineering Materials and Technology* **113** , 162-170 (1991).
- [59] Méric and Cailletaud, G., Single Crystal Modeling for Structural Calculations: Part 2 - Finite Element Implementation. *Journal of Engineering Materials and Technology* **113** , 171-182 (1991).
- [60] Merz, S., *Anwendung des Zienkiewicz-Zhu-Fehlerabschätzers auf Triebwerksstrukturen*. Diplomarbeit-Nr. 06/56, Hochschule Karlsruhe - Technik und Wirtschaft, Fakultät für Maschinenbau (2006).
- [61] Miller, D.S., *Internal Flow Systems*. British Hydromechanics Research Association (B.H.R.A.) Fluid Engineering Series (1978).
- [62] Miranda, I., Ferencz, R.M. and Hughes, T.J.R., An improved implicit-explicit time integration method for structural dynamics. *Earthquake Engineering and Structural Dynamics* **18** , 643-653 (1989).
- [63] Mittal, S., Finite element computation of unsteady viscous compressible flows. *Comput. Meth. Appl. Mech. Eng.* **157** , 151-175 (1998).
- [64] Möhring, U.K., *Untersuchung des radialen Druckverlaufes und des übertragenen Drehmomentes im Radseitenraum von Kreiselpumpen bei glatter, ebener Radseitenwand und bei Anwendung von Rückenschaukeln*. Technische Universität Carolo-Wilhelmina zu Braunschweig (1976).
- [65] Monjaraz Tec, C.D., *Application of Stability Criteria in Penalty Contact Formulation for Explicit Dynamic Simulations in CalculiX*. Master Thesis at the Technical Universität München (2016).
- [66] Monjaraz Tec, C.D., Gross, J. and Krack, M., A massless boundary component mode synthesis method for elastodynamic contact problems. *Computers & Structures*. **260** (2022) 106698.
- [67] Moran, M.J. and Shapiro, H.N., *Fundamentals of Engineering Thermodynamics*. Wiley (2006).
- [68] Mortelmans, F., *Berekening van konstrukties, deel 3, Gewapend Beton I*. ACCO, Leuven (1981).
- [69] Muller, Y., *Coupled Thermo-Mechanical Fluid-Structure Interaction in the Secondary Air System of Aircraft Engines*. Ph.D. Thesis, University of Valenciennes - Université de Valenciennes et du Hainaut Cambresis (2009).

- [70] Olovsson, L. and Simonsson, K., Iterative solution technique in selective mass scaling. *Communications in Numerical Methods in Engineering*. **22** , 77-82 (2006).
- [71] Pacher, M., *On the Energy Conservation in the dynamic Contact solved by implicit dynamic Finite Element Method*. Master Thesis, University of Trento, Department of Industrial Engineering, Italy (2016).
- [72] Parker, D.M. and Kercher, D.M., An enhanced method to compute the compressible discharge coefficient of thin and long orifices with inlet corner radiusing. *Heat Transfer in Gas Turbine Engines* HTD-**188** , 53-63 (ASME 1991).
- [73] Patankar, S.V. and Spalding, D.B., A calculation procedure for heat, mass and momentum transfer in three-dimensional parabolic flows *Int. J. Heat Mass Transfer*. **15** , 1787-1806 (1972).
- [74] Pfoertner, H., <http://www.enginemonitoring.org/opti/fminsi.zip> and <http://www.enginemonitoring.org/opti/readme.txt>. Accessed on October 9th, 2021.
- [75] Pope, S.B., *Turbulent Flows*. Cambridge University Press(2001).
- [76] Popov, P.P., *Introduction to mechanics of solids*. Prentice-Hall, New Jersey (1968).
- [77] Pulliam, T.H. and Barton, J.T., Euler computations of AGARD working group 07 airfoil test cases. *AIAA-85-0018* (1985).
- [78] Rama, G., Marinkovic, D. and Zehn, M., A three-node shell element based on the discrete shear gap and assumed natural deviatoric strain approaches. *J. Braz. Soc. Mech. Sci. Eng.* **40** , 356, (2018). <https://doi.org/10.1007/s40430-018-1276-4>.
- [79] Rank, E., Ruecker, M. *Private Communication* . TU Munich (2000).
- [80] Richard, H.A., Fulland, M. and Sander, M., Theoretical crack path prediction *Fatigue Fract. Engng. Mater. Struct.*. **28** , 3-12 (2004).
- [81] Richter, H., *Rohrhydraulik*. Springer, Berlin-Heidelberg (1971).
- [82] Richard, H.A., Fulland, M. and Sander, M., Theoretical crack path prediction *Fatigue Fract. Engng. Mater. Struct.*. **28** , 3-12 (2004).
- [83] Schlichting, H. and Gersten, K., *Grenzschichttheorie*. Springer-Verlag Berlin Heidelberg (2006).
- [84] Scholz, N., *Aerodynamik der Schaufelgitter*. Schaufelgitter, Band 1, Karlsruhe Braun Verlag (1965).

- [85] Schwarz, H.R., *FORTRAN-Programme zur Methode der finiten Elemente*. Teubner (1981).
- [86] Silvester, P.P. and Ferrari, R.L., *Finite elements for electrical engineers*. Cambridge University Press (1996).
- [87] Simo, J.C. and Hughes, T.J.R., *Computational Inelasticity*. Springer, New York (1997).
- [88] Simo, J.C. and Taylor, R.L., Quasi-incompressible finite elasticity in principal stretches. Continuum basis and numerical algorithms. *Computer Methods in Applied Mechanics and Engineering*. **85**, 273-310 (1991).
- [89] Simo, J.C., A framework for finite strain elastoplasticity based on maximum plastic dissipation and the multiplicative decomposition: Part I. Continuum formulation. *Computer Methods in Applied Mechanics and Engineering*. **66**, 199-219 (1988).
- [90] Simo, J.C., A framework for finite strain elastoplasticity based on maximum plastic dissipation and the multiplicative decomposition: Part II: computational aspects. *Computer Methods in Applied Mechanics and Engineering*. **68**, 1-31 (1988).
- [91] Sitzmann, S., Willner, K. and Wohlmuth, B.I., A dual Lagrange method for contact problems with regularized contact conditions. *Int. J. Num. Meth. Engng.* **99**(3), 221-238 (2014).
- [92] Sitzmann, S., Willner, K. and Wohlmuth, B.I., A dual Lagrange method for contact problems with regularized frictional contact conditions: Modelling micro slip *Computer Methods in Applied Mechanics and Engineering*. **285**, 468-487 (2015).
- [93] Sitzmann, S., Willner, K. and Wohlmuth, B.I., Variationally consistent quadratic finite element contact formulations for finite deformation contact problems on rough surfaces. *Finite Elements in Analysis and Design*. **109**, 37-53 (2015).
- [94] Sitzmann, S., *Robust algorithms for contact problems with constitutive contact laws*. Ph.D. Thesis, Friedrich-Alexander-Universität Erlangen-Nürnberg (2015).
- [95] Sloan, S.W., A FORTRAN program for profile and wavefront reduction. *Int. J. Num. Meth. Engng.* **28**, 2651-2679 (1989).
- [96] Smith, A.J. Ward, *Internal fluid flow*. Oxford University Press (1980).
- [97] Sørensen, Emil Smed *Elasto-Plastic Strain Hardening Mohr-Coulomb Model*. Master Thesis, Aalborg University (2012), <https://vbm.aau.dk>, last accessed July 10, 2023.

- [98] Spalart, P.R., and Rumsey, C.L., Effective Inflow Conditions for Turbulence Models in Aerodynamic Calculations. *AIAA Journal*. **45**(10) , 2544-2553 (2007).
- [99] Studer, C., *Numerics of Unilateral Contacts and Friction*. Lecture Notes in Applied and Computational Mechanics Vol 47. Springer Verlag Berlin Heidelberg (2009).
- [100] Taylor, R.L, Beresford, P.J. and Wilson, E.L., A non-conforming element for stress analysis. *Int. J. Num. Meth. Engng.* **10** , 1211-1219 (1976).
- [101] Van Doormal, J.P. and Raithby, G.D., Enhancements of the SIMPLE method for predicting incompressible fluid flows. *Num. Heat Transfer*. **7** , 147-163 (1984).
- [102] Vazsonyi, A., Pressure loss in elbows and duct branches. *Trans. ASME* **66**, 177-183 (1944).
- [103] Washizu, K., Some considerations on a naturally curved and twisted slender beam. *Journal of Mathematics and Physics* **43** , 111-116.
- [104] Wilcox, D.C., *Turbulence modeling for CFD*. La Cañada, CA: DCW Industries (1993).
- [105] Wriggers, P., *Computational Contact Mechanics*. John Wiley & Sons (2002).
- [106] Yunhua, Luo, An Efficient 3D Timoshenko Beam Element with Consistent Shape Functions. *Adv. Theor. Appl. Mech.* **1** , no. 3, 95-106 (2008).
- [107] Zienkiewicz, O.C. and Codina, R., A general algorithm for compressible and incompressible flow - Part 1: The split, characteristic-based scheme. *Int. J. Num. Meth. Fluids* **20**, 869-885 (1995).
- [108] Zienkiewicz, O.C., Morgan, K. and Satya Sai, B.V.K., A general algorithm for compressible and incompressible flow - Part II. Tests on the explicit form. *Int. J. Num. Meth. Fluids* **20**, 887-913 (1995).
- [109] Zienkiewicz, O.C. and Taylor, R.L., *The finite element method*. McGraw-Hill Book Company (1989).
- [110] Zienkiewicz, O.C., Taylor, R.L. and Nithiarasu, P., *The finite element method for fluid dynamics*. 6th edition, Elsevier (2006).
- [111] Zienkiewicz, O.C. and Zhu, J.Z., The superconvergent patch recovery and a posteriori error estimates. Part 1: The recovery technique. *Int. J. Num. Meth. Engng.* **33**, 1331-1364 (1992).
- [112] Zienkiewicz, O.C. and Zhu, J.Z., The superconvergent patch recovery and a posteriori error estimates. Part 2: Error estimates and adaptivity. *Int. J. Num. Meth. Engng.* **33**, 1365-1382 (1992).

- [113] Zimmermann, H., Some aerodynamic aspects of engine secondary air systems. *ASME* 889-GT-209.